

Leiterplatten-Layout Vorschlag für SMT
PCB-Layout Proposal for SMT

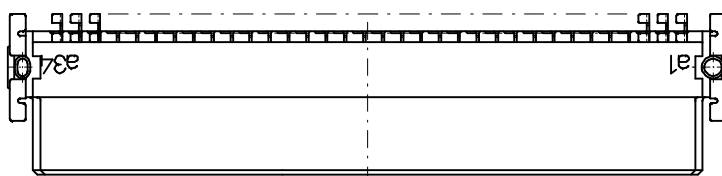

Verpackt in Gurtverpackung - Tape on Reel Packaging
Verpackungseinheit: 560 Stück - Packaging unit: 560 pcs

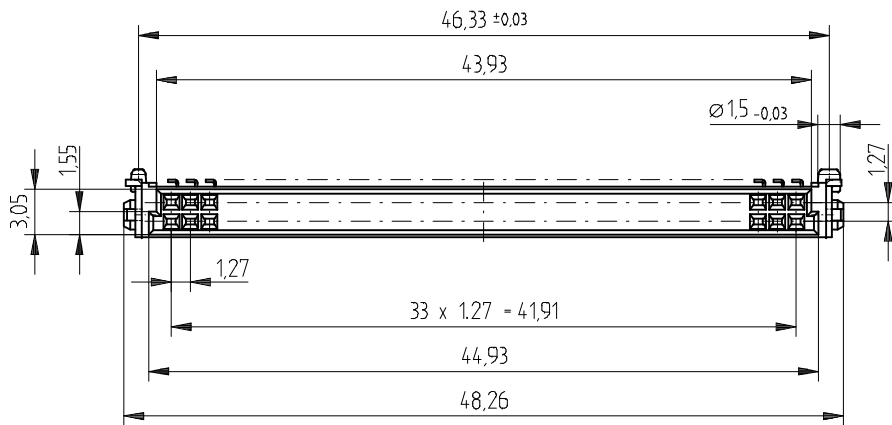
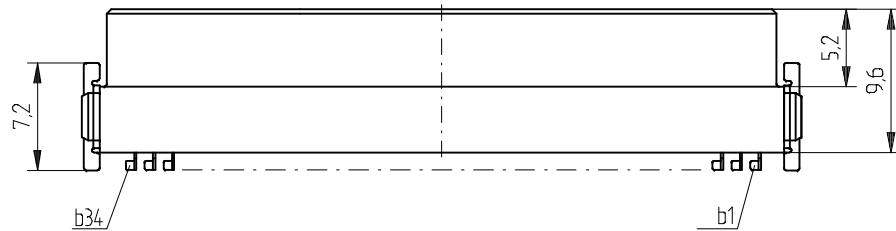
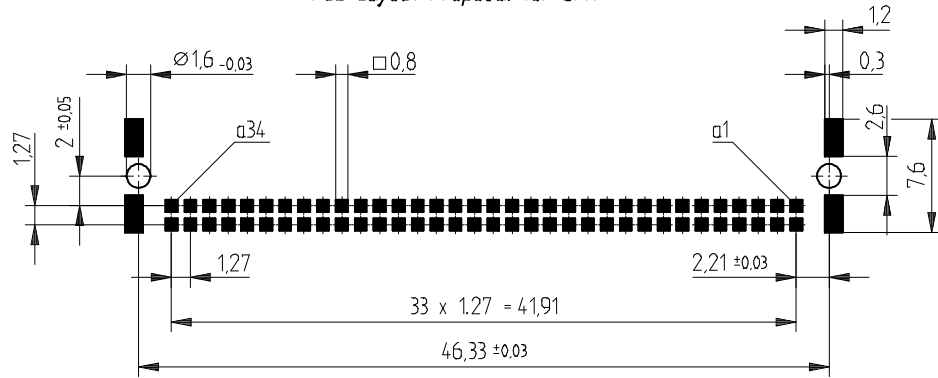
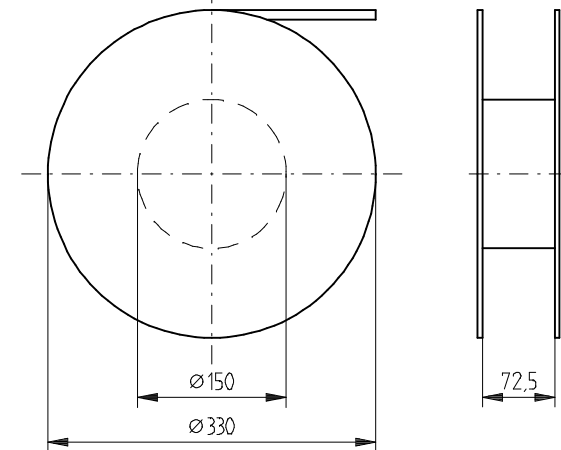

Abspulrichtung - Reel off Direction

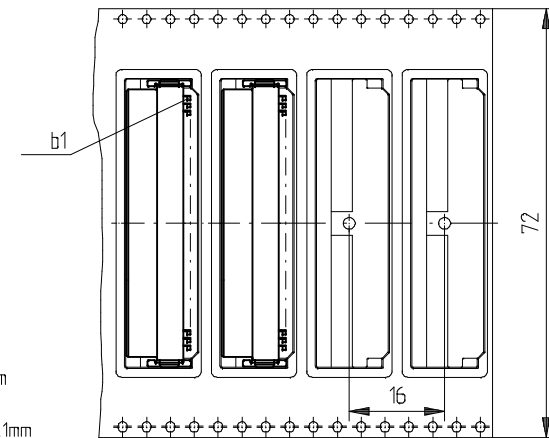
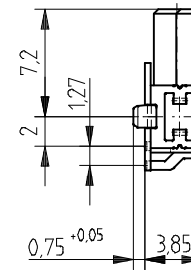

Anforderungsstufe 1
Performance Level 1
Kontaktbereich vergoldet
Mating Area gold plating
Anschlussbereich verzinkt 4-6 µm
Terminal Area 4-6 µm tin plating
Koplanarität der Anschlüsse ≤ 0.1mm
Coplanarity Area of Termination ≤ 0.1 mm

BA7-03 - Standard Bauhöhe
type7-03 - Standard Assembly Height

Information: All rights reserved. Only for information. To insure that this is the latest version of this drawing, please contact one of the ERNI companies before using.	Tolerances All Dimensions in mm	Scale 3:1 XXXXXX Angaben zu entsprechender Ident-Nr. siehe Fertigungsunterlagen For further information about I.D. number see manufacturing document.
	Subject to modification without prior notice. Drawing will not be updated.	Designation Federl. SMC-Q 68-SMD-BA7-03 Female SMC-Q 68-SMD-type7-03
www.ERNI.com	154743	1
Date	V:00039950.S2N	SMCQ

Consider protection memo from DIN 34