

LOC	DIST	REVISIONS					
E	B	P	LTR	DESCRIPTION	DATE	DWN	APVD
			BA	NEW RELEASE	14-NOV-08	SM	St.P

FOR FURTHER INFORMATION SEE DATA SHEET FOR
3640 SERIES-HIGH FREQUENCY INDUCTORS SMD

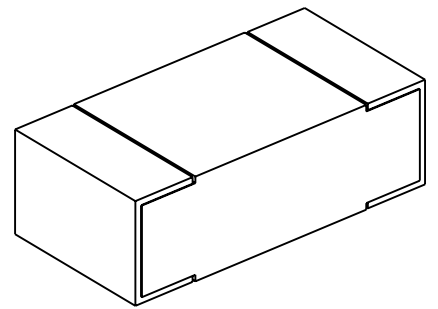

RoHS Compliant



2008

RELEASED FOR PUBLICATION

THIS DRAWING IS UNPUBLISHED.

BY TYCO ELECTRONICS CORPORATION. ALL RIGHTS RESERVED.

DIMENSIONS: mm	DWN	14-NOV-08	MATERIAL	-	FINISH	-
	CHK	14-NOV-08	Tyco Electronics Corporation Dorcan, Swindon, SN3 5HH			
TOLERANCES UNLESS OTHERWISE SPECIFIED:	APVD	14-NOV-08				
0 PLC ± 0.2	STEPHEN.P		NAME HIGH FREQUENCY INDUCTORS SMD SERIES 3640 0402			
1 PLC ± 0.1	PRODUCT SPEC	-				
2 PLC \pm	APPLICATION SPEC	-	SIZE	CAGE CODE	DRAWING NO	RESTRICTED TO
3 PLC \pm			A 4	00779	C- 1624108	-
4 PLC \pm	WEIGHT	-	CUSTOMER DRAWING			
ANGLES $\pm 5^\circ$			SCALE	50:1	SHEET	1 OF 1
						REV BA

Mouser Electronics

Authorized Distributor

Click to View Pricing, Inventory, Delivery & Lifecycle Information:

[TE Connectivity:](#)

[36401E2N3ATDF](#)