

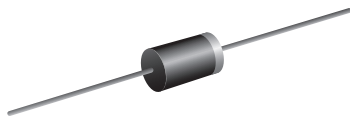

Glass Passivated Junction Plastic Rectifier

SUPERECTIFIER®



DO-41 (DO-204AL)

FEATURES

- Superectifier structure for high reliability application
- Cavity-free glass-passivated junction
- Low forward voltage drop
- Low leakage current
- High forward surge capability
- Solder dip 275 °C max. 10 s, per JESD 22-B106
- Material categorization: for definitions of compliance please see www.vishay.com/doc?99912



TYPICAL APPLICATIONS

For use in general purpose rectification of power supplies, inverters, converters and freewheeling diodes for consumer applications.

MECHANICAL DATA

Case: DO-41 (DO-204AL), molded epoxy over glass body

Molding compound meets UL 94 V-0 flammability rating
Base P/N-E3 - RoHS-compliant, commercial grade

Terminals: matte tin plated leads, solderable per J-STD-002 and JESD 22-B102

E3 suffix meets JESD 201 class 1A whisker test

Polarity: color band denotes cathode end

PRIMARY CHARACTERISTICS

$I_{F(AV)}$	1.0 A
V_{RRM}	50 V to 1600 V
I_{FSM}	30 A, 25 A
I_R	5.0 μ A
V_F	1.1 V, 1.2 V, 1.3 V
T_J max.	175 °C
Package	DO-41 (DO-204AL)
Circuit configuration	Single

MAXIMUM RATINGS ($T_A = 25$ °C unless otherwise noted)

PARAMETER	SYMBOL	A	B	D	G	J	K	M	N	Q	T	V	W	Y	UNIT	
Maximum repetitive peak reverse voltage	V_{RRM}	50 to 1600 (fig. 5)														V
Maximum average forward rectified current 0.375" (9.5 mm) lead length (fig. 1)	$I_{F(AV)}$	1.0														A
Peak forward surge current 8.3 ms single half sine-wave superimposed on rated load	I_{FSM}	30						25						A		
Maximum full load reverse current, full cycle average, 0.375" (9.5 mm) lead length at $T_A = 75$ °C	$I_{R(AV)}$	30														μ A
Operating junction and storage temperature range	T_J, T_{STG}	-65 to +175						-65 to +150						°C		



ELECTRICAL CHARACTERISTICS ($T_A = 25\text{ }^\circ\text{C}$ unless otherwise noted)																
PARAMETER	TEST CONDITIONS	SYMBOL	A	B	D	G	J	K	M	N	Q	T	V	W	Y	UNIT
Maximum instantaneous forward voltage	1.0 A	V_F	1.1			1.2			1.3						V	
Maximum DC reverse current at rated DC blocking voltage	$T_A = 25\text{ }^\circ\text{C}$	I_R	5.0												μA	
	$T_A = 125\text{ }^\circ\text{C}$		50													
Typical reverse recovery time	$I_F = 0.5\text{ A}$, $I_R = 1.0\text{ A}$, $I_{rr} = 0.25\text{ A}$	t_{rr}	3.0												μs	
Typical junction capacitance	4.0 V, 1 MHz	C_J	8.0			7.0			5.0						pF	

THERMAL CHARACTERISTICS ($T_A = 25\text{ }^\circ\text{C}$ unless otherwise noted)																
PARAMETER	SYMBOL	A	B	D	G	J	K	M	N	Q	T	V	W	Y	UNIT	
Typical thermal resistance	$R_{\theta JA}^{(1)}$	55												$^\circ\text{C/W}$		

Note

⁽¹⁾ Thermal resistance from junction to ambient at 0.375" (9.5 mm) lead length, P.C.B. mounted

ORDERING INFORMATION (Example)				
PREFERRED P/N	UNIT WEIGHT (g)	PREFERRED PACKAGE CODE	BASE QUANTITY	DELIVERY MODE
GP10J-E3/54	0.335	54	5500	13" diameter paper tape and reel
GP10J-E3/73	0.335	73	3000	Ammo pack packaging



RATINGS AND CHARACTERISTICS CURVES ($T_A = 25\text{ }^\circ\text{C}$ unless otherwise noted)

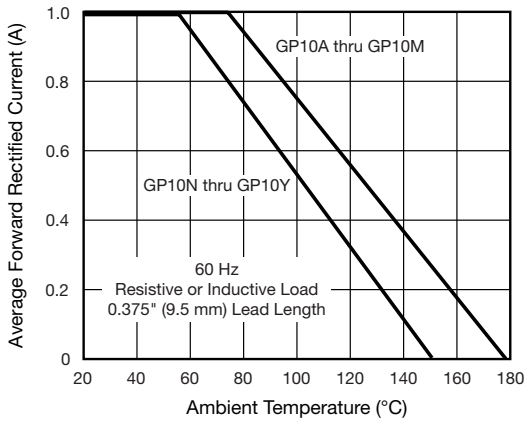

Fig. 1 - Forward Current Derating Curve

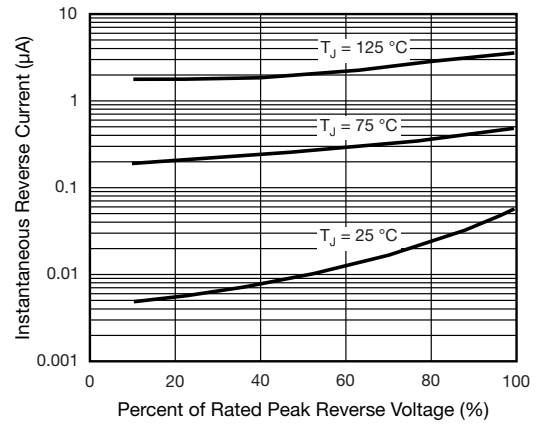

Fig. 4 - Typical Reverse Characteristics

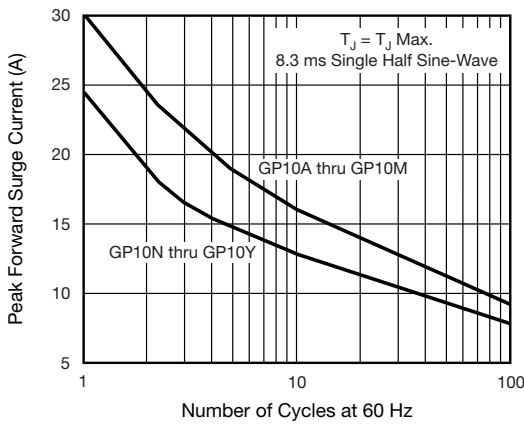

Fig. 2 - Maximum Non-repetitive Peak Forward Surge Current

GP10A.....	50 V
GP10B.....	100 V
GP10D.....	200 V
GP10G.....	400 V
GP10J.....	600 V
GP10K.....	800 V
GP10M.....	1000 V
GP10N.....	1100 V
GP10Q.....	1200 V
GP10T.....	1300 V
GP10V.....	1400 V
GP10W.....	1500 V
GP10Y.....	1600 V

Fig. 5 - Maximum Repetitive Peak Reverse Voltage, V_{RRM}

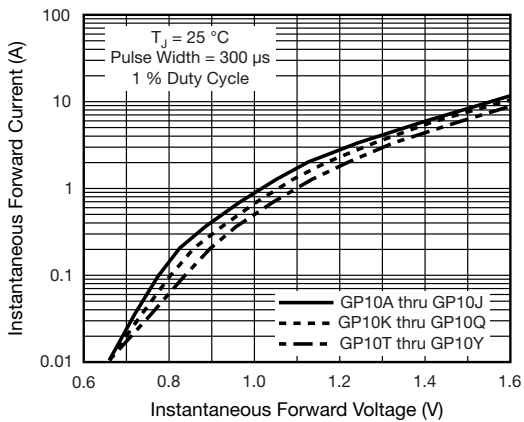

Fig. 3 - Typical Instantaneous Forward Characteristics

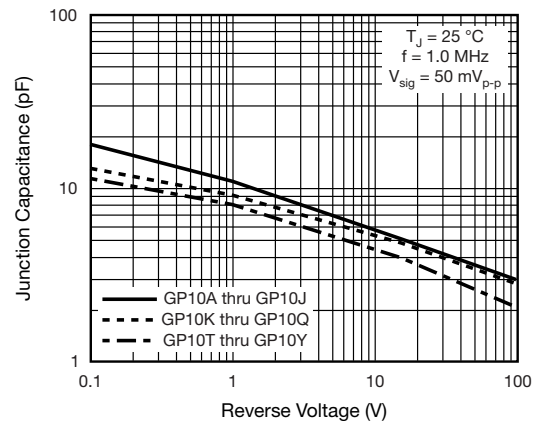
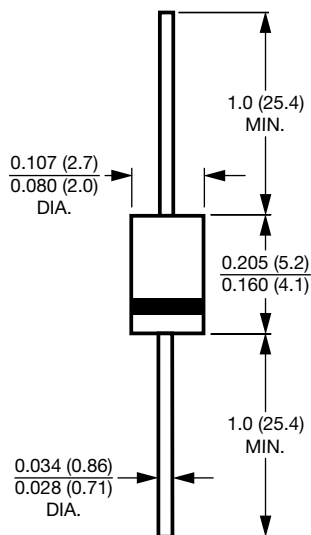

Fig. 6 - Typical Junction Capacitance



PACKAGE OUTLINE DIMENSIONS in inches (millimeters)

DO-41 (DO-204AL)



Note

- Lead diameter is $\frac{0.026 (0.66)}{0.023 (0.58)}$ for suffix "E" part numbers



Disclaimer

ALL PRODUCT, PRODUCT SPECIFICATIONS AND DATA ARE SUBJECT TO CHANGE WITHOUT NOTICE TO IMPROVE RELIABILITY, FUNCTION OR DESIGN OR OTHERWISE.

Vishay Intertechnology, Inc., its affiliates, agents, and employees, and all persons acting on its or their behalf (collectively, "Vishay"), disclaim any and all liability for any errors, inaccuracies or incompleteness contained in any datasheet or in any other disclosure relating to any product.

Vishay makes no warranty, representation or guarantee regarding the suitability of the products for any particular purpose or the continuing production of any product. To the maximum extent permitted by applicable law, Vishay disclaims (i) any and all liability arising out of the application or use of any product, (ii) any and all liability, including without limitation special, consequential or incidental damages, and (iii) any and all implied warranties, including warranties of fitness for particular purpose, non-infringement and merchantability.

Statements regarding the suitability of products for certain types of applications are based on Vishay's knowledge of typical requirements that are often placed on Vishay products in generic applications. Such statements are not binding statements about the suitability of products for a particular application. It is the customer's responsibility to validate that a particular product with the properties described in the product specification is suitable for use in a particular application. Parameters provided in datasheets and / or specifications may vary in different applications and performance may vary over time. All operating parameters, including typical parameters, must be validated for each customer application by the customer's technical experts. Product specifications do not expand or otherwise modify Vishay's terms and conditions of purchase, including but not limited to the warranty expressed therein.

Hyperlinks included in this datasheet may direct users to third-party websites. These links are provided as a convenience and for informational purposes only. Inclusion of these hyperlinks does not constitute an endorsement or an approval by Vishay of any of the products, services or opinions of the corporation, organization or individual associated with the third-party website. Vishay disclaims any and all liability and bears no responsibility for the accuracy, legality or content of the third-party website or for that of subsequent links.

Except as expressly indicated in writing, Vishay products are not designed for use in medical, life-saving, or life-sustaining applications or for any other application in which the failure of the Vishay product could result in personal injury or death. Customers using or selling Vishay products not expressly indicated for use in such applications do so at their own risk. Please contact authorized Vishay personnel to obtain written terms and conditions regarding products designed for such applications.

No license, express or implied, by estoppel or otherwise, to any intellectual property rights is granted by this document or by any conduct of Vishay. Product names and markings noted herein may be trademarks of their respective owners.

Mouser Electronics

Authorized Distributor

Click to View Pricing, Inventory, Delivery & Lifecycle Information:

Vishay:

[GP10-4002-E3/53](#) [GP10-4002E-E3/53](#) [GP10-4002EHE3/53](#) [GP10-4002EHE3/54](#) [GP10-4002EHE3/73](#) [GP10-4002HE3/53](#) [GP10-4002HE3/54](#) [GP10-4002HE3/73](#) [GP10-4003E-E3/53](#) [GP10-4003EHE3/53](#) [GP10-4003EHE3/54](#) [GP10-4003EHE3/73](#) [GP10-4003HE3/54](#) [GP10-4003HE3/73](#) [GP10-4004-E3/53](#) [GP10-4004E-E3/53](#) [GP10-4004EHE3/53](#) [GP10-4004EHE3/54](#) [GP10-4004EHE3/73](#) [GP10-4004HE3/53](#) [GP10-4004HE3/54](#) [GP10-4004HE3/73](#) [GP10-4005E-E3/53](#) [GP10-4005EHE3/53](#) [GP10-4005EHE3/54](#) [GP10-4005EHE3/73](#) [GP10-4005HE3/54](#) [GP10-4005HE3/73](#) [GP10-4006EHE3/54](#) [GP10-4006HE3/54](#) [GP10-4006HE3/73](#) [GP10-4007-E3/53](#) [GP10-4007E-E3/53](#) [GP10-4007EHE3/53](#) [GP10-4007EHE3/54](#) [GP10-4007EHE3/73](#) [GP10-4007HE3/53](#) [GP10-4007HE3/54](#) [GP10-4007HE3/73](#) [GP10A-E3/51](#) [GP10A-E3/54](#) [GP10A-E3/73](#) [GP10AHE3/54](#) [GP10AHE3/73](#) [GP10B-E3/54](#) [GP10B-E3/73](#) [GP10BE-E3/54](#) [GP10BEHE3/54](#) [GP10BHE3/54](#) [GP10BHE3/73](#) [GP10D-E3/54](#) [GP10D-E3/73](#) [GP10DE-E3/54](#) [GP10DEHE3/54](#) [GP10DHE3/54](#) [GP10DHE3/73](#) [GP10F-E3/54](#) [GP10FHE3/54](#) [GP10G-E3/54](#) [GP10G-E3/73](#) [GP10GE-E3/15](#) [GP10GE-E3/53](#) [GP10GE-E3/54](#) [GP10GE-E3/73](#) [GP10GE-E3/91](#) [GP10GEHE3/53](#) [GP10GEHE3/54](#) [GP10GEHE3/73](#) [GP10GEHE3/91](#) [GP10GHE3/54](#) [GP10GHE3/73](#) [GP10J-E3/51](#) [GP10J-E3/54](#) [GP10J-E3/73](#) [GP10JE-E3/23](#) [GP10JE-E3/54](#) [GP10JE-E3/73](#) [GP10JEHE3/54](#) [GP10JEHE3/73](#) [GP10JHE3/54](#) [GP10JHE3/73](#) [GP10K-E3/51](#) [GP10K-E3/54](#) [GP10K-E3/73](#) [GP10KE-E3/54](#) [GP10KEHE3/54](#) [GP10KHE3/54](#) [GP10KHE3/73](#) [GP10M-E3/51](#) [GP10M-E3/54](#) [GP10M-E3/73](#) [GP10ME-E3/53](#) [GP10ME-E3/54](#) [GP10ME-E3/73](#) [GP10MEHE3/53](#) [GP10MEHE3/54](#) [GP10MEHE3/73](#) [GP10MHE3/54](#) [GP10MHE3/73](#) [GP10N-E3/54](#)