

TECHNICAL DATA

| | |
|---|--|
| General technical data | VDE 0560 , IEC 071 , EN 61071 |
| Application class (DIN 40040) | GPD / LS |
| Temperature range (Case) | -40 to + 85 °C |
| Max permissible ambient temperature | +70 °C |
| Capacitance tolerance code (15 th digit) | J = ± 5% ; K = ± 10% |
| Test voltage terminal to case U _{TT} | 1.5 U _{RMS} for 60 seconds |
| Test voltage terminal to case U _{TC} | 3kV - 50Hz for 60 seconds |
| Rated insulation voltage U _i | 700 V - 50 Hz - Insulation group B (VDE 0110 part 1) |
| Permissible relative humidity | Annual average ≤ 95% on 30 days / year, continuously 100% on other days occasionally 100%. Dewing not admissible |
| IEC climatic category | 40 / 85 / 21 |
| Degree of protection | IP00 |
| Capacitance deviation in the operating temperature range of -40 to +85 °C | ±1.5% max on capacitance value measured at +20 °C |
| Change of capacitance versus operating time | -3% after 30.000 hours at U _{RMS} or after 100.000 hours at Un |
| Case components | Aluminium case plus plastic insulating deck flame retardant execution (UL class 94 V1) . |
| Terminals | Tinned brass fastons or screws (See figure on top) |
| Installation | Whatever Position |
| Life Expectancy | ≥ 30.000 hours at U _{RMS} ; ≥ 100.000 hours at Un |
| Failure quota | 300 / 10 ⁹ components hour |

PEAK VOLTAGE TABLE

| Un Vdc | U _{PK} Vdc | U _{RMS} Vac |
|-----------|------------------------|-------------------------|
| 400 | 600 | 250 |
| 600 | 800 | 330 |

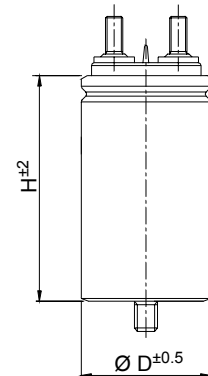

GENERAL CHARACTERISTICS

| Code | C µF | Un Vdc | K °C/W | Tgδ x 10 ⁻⁴ | | ESR Typ. mΩ | dv/dt V/µs | I _{RMS} A | I _{PKR} A | Case | | Approx Weight g |
|-----------------|---------|-----------|-----------|------------------------|------|-------------------|---------------|-----------------------|-----------------------|------|-----|-----------------------|
| | | | | Max | Typ. | | | | | D | H | |
| C44AFFP5150ZA0J | 15 | 400 | 7.8 | 10 | 5 | 5 | 30 | 16 | 450 | 45 | 80 | 135 |
| C44AFFP5200ZE0J | 20 | 400 | 6.2 | 10 | 5 | 5 | 30 | 18 | 600 | 45 | 80 | 135 |
| C44AFFP5220ZA0J | 22 | 400 | 6.2 | 12 | 6 | 5 | 30 | 18 | 660 | 45 | 80 | 135 |
| C44AFFP5250ZA0J | 25 | 400 | 6.2 | 12 | 7 | 5 | 30 | 18 | 750 | 45 | 80 | 135 |
| C44AFFP5300ZA0J | 30 | 400 | 3.5 | 20 | 15 | 6 | 20 | 22 | 600 | 50 | 101 | 200 |
| C44AFFP5400ZA0J | 40 | 400 | 2.7 | 20 | 15 | 6 | 20 | 25 | 800 | 50 | 101 | 200 |
| C44AFFP5500ZE0J | 50 | 400 | 2.6 | 20 | 15 | 6 | 20 | 25 | 1000 | 50 | 101 | 200 |
| C44AFGP5600ZA0J | 60 | 400 | 2.6 | 25 | 15 | 6 | 20 | 25 | 1200 | 60 | 101 | 240 |
| C44AFGP5750ZA0J | 75 | 400 | 3.2 | 30 | 20 | 5 | 20 | 30 | 1500 | 60 | 101 | 240 |
| C44AFGP6100ZG0J | 100 | 400 | 4.0 | 30 | 20 | 4 | 15 | 32 | 1500 | 60 | 138 | 315 |
| C44AFGP6130ZA0J | 130 | 400 | 4.0 | 30 | 20 | 4 | 15 | 32 | 2000 | 65 | 138 | 360 |
| C44AFGP6150ZA0J | 150 | 400 | 4.0 | 40 | 30 | 4 | 15 | 32 | 2250 | 70 | 138 | 530 |
| C44AFGP6200ZE0J | 200 | 400 | 4.0 | 40 | 30 | 4 | 10 | 32 | 2000 | 76 | 138 | 740 |
| C44AFGR6250ZA0J | 250 | 400 | 4.0 | 40 | 30 | 4 | 10 | 32 | 2500 | 85 | 150 | 900 |
| C44AFGR6300ZA0J | 300 | 400 | 1.25 | 50 | 40 | 5 | 20 | 50 | 6000 | 85 | 185 | 1080 |
| C44AFGR6330ZA0J | 330 | 400 | 1.25 | 50 | 40 | 5 | 20 | 50 | 6000 | 85 | 185 | 1150 |
| C44AHFP5100ZA0J | 10 | 600 | 7.8 | 10 | 5 | 5 | 40 | 16 | 400 | 45 | 80 | 135 |
| C44AHFP5150ZA0J | 15 | 600 | 7.7 | 10 | 5 | 4 | 40 | 18 | 600 | 45 | 105 | 160 |
| C44AHFP5200ZB0J | 20 | 600 | 5.2 | 15 | 6 | 4 | 30 | 22 | 600 | 45 | 101 | 160 |
| C44AHFP5220ZA0J | 22 | 600 | 5.3 | 15 | 6 | 3 | 30 | 25 | 660 | 50 | 101 | 200 |
| C44AHFP5250ZB0J | 25 | 600 | 3.5 | 20 | 15 | 6 | 20 | 22 | 600 | 50 | 101 | 200 |
| C44AHFP5300ZC0J | 30 | 600 | 10.3 | 15 | 7 | 2 | 30 | 25 | 900 | 50 | 101 | 200 |
| C44AHGP5330ZA0J | 33 | 600 | 8.0 | 15 | 7 | 2 | 30 | 25 | 990 | 55 | 101 | 235 |
| C44AHGP5400ZB0J | 40 | 600 | 8.0 | 10 | 6 | 2 | 30 | 25 | 1200 | 60 | 101 | 240 |
| C44AHGP5500ZG0J | 50 | 600 | 3.2 | 15 | 10 | 5 | 20 | 25 | 1000 | 55 | 138 | 300 |
| C44AHGP5600ZB0J | 60 | 600 | 3.1 | 15 | 8 | 5 | 20 | 32 | 1200 | 60 | 138 | 315 |
| C44AHGP5700ZA0J | 70 | 600 | 3.2 | 25 | 15 | 5 | 20 | 32 | 1400 | 65 | 138 | 360 |
| C44AHGP5750ZA0J | 75 | 600 | 3.2 | 25 | 15 | 5 | 20 | 32 | 1500 | 65 | 138 | 360 |
| C44AHGP5800ZA0J | 80 | 600 | 3.2 | 25 | 15 | 5 | 20 | 32 | 1600 | 65 | 135 | 530 |
| C44AHGP6100ZA0J | 100 | 600 | 3.2 | 25 | 15 | 5 | 20 | 32 | 2000 | 76 | 135 | 625 |
| C44AHGR6100ZB0J | 100 | 600 | 1.25 | 15 | 10 | 5 | 30 | 50 | 3000 | 85 | 138 | 770 |

PEAK VOLTAGE TABLE

| Un Vdc | U _{PK} Vdc | U _{RMS} Vac |
|-----------|------------------------|-------------------------|
| 700 | 900 | 400 |
| 850 | 1000 | 450 |

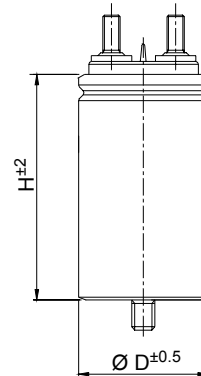

GENERAL CHARACTERISTICS

| Code | C µF | Un Vdc | K °C/W | Tgδ x 10 ⁻⁴ | | ESR Typ. mΩ | dv/dt V/µs | I _{RMS} A | I _{PKR} A | Case | | Approx Weight g |
|-----------------|---------|-----------|-----------|------------------------|------|-------------------|---------------|-----------------------|-----------------------|------|-----|-----------------------|
| | | | | Max | Typ. | | | | | D | H | |
| C44AJFP4500ZA0J | 5 | 700 | 13.0 | 8 | 2 | 3 | 50 | 16 | 250 | 45 | 80 | 135 |
| C44AJFP4600ZA0J | 6 | 700 | 13.0 | 8 | 2 | 3 | 50 | 16 | 300 | 45 | 80 | 135 |
| C44AJFP4750ZA0J | 7.5 | 700 | 10.3 | 10 | 3 | 3 | 50 | 18 | 375 | 45 | 80 | 135 |
| C44AJFP5100ZA0J | 10 | 700 | 10.0 | 10 | 3 | 3 | 50 | 18 | 500 | 50 | 101 | 200 |
| C44AJFP5150ZB0J | 15 | 700 | 5.3 | 15 | 6 | 3 | 40 | 25 | 600 | 50 | 101 | 200 |
| C44AJFP5200ZD0J | 20 | 700 | 5.3 | 15 | 10 | 3 | 40 | 25 | 800 | 50 | 101 | 200 |
| C44AJGP5220ZA0J | 22 | 700 | 5.3 | 15 | 10 | 3 | 40 | 25 | 880 | 55 | 101 | 235 |
| C44AJGP5250ZA0J | 25 | 700 | 5.3 | 15 | 10 | 3 | 40 | 25 | 1000 | 60 | 101 | 240 |
| C44AJGP5300ZB0J | 30 | 700 | 5.3 | 15 | 12 | 3 | 30 | 25 | 900 | 60 | 138 | 310 |
| C44AJGP5330ZA0J | 33 | 700 | 5.3 | 15 | 10 | 3 | 35 | 25 | 990 | 60 | 138 | 310 |
| C44AJGP5400ZA0J | 40 | 700 | 4.0 | 25 | 15 | 4 | 35 | 32 | 1200 | 65 | 138 | 360 |
| C44AJGP5500ZA0J | 50 | 700 | 4.0 | 25 | 15 | 4 | 35 | 32 | 1500 | 65 | 138 | 360 |
| C44AJGP5600ZA0J | 60 | 700 | 4.0 | 25 | 15 | 4 | 30 | 32 | 1800 | 76 | 138 | 625 |
| C44AJGP5700ZA0J | 70 | 700 | 4.0 | 25 | 15 | 4 | 30 | 32 | 2100 | 76 | 138 | 625 |
| C44AJGR5750ZA0J | 75 | 700 | 4.0 | 25 | 15 | 4 | 30 | 32 | 2250 | 85 | 137 | 770 |
| C44AJGR6100ZA0J | 100 | 700 | 2.0 | 15 | 10 | 3 | 40 | 50 | 4000 | 85 | 185 | 1150 |
| C44AMFP4300ZA0J | 3 | 850 | 7.8 | 10 | 5 | 5 | 60 | 16 | 180 | 45 | 80 | 135 |
| C44AMFP4500ZA0J | 5 | 850 | 7.8 | 10 | 5 | 5 | 60 | 16 | 300 | 45 | 80 | 135 |
| C44AMFP4600ZA0J | 6 | 850 | 6.2 | 10 | 5 | 5 | 60 | 18 | 360 | 45 | 80 | 135 |
| C44AMFP4800ZA0J | 8 | 850 | 4.1 | 10 | 6 | 5 | 50 | 22 | 400 | 45 | 105 | 200 |
| C44AMFP5100ZD0J | 10 | 850 | 3.2 | 10 | 6 | 5 | 50 | 25 | 500 | 50 | 101 | 200 |
| C44AMGP5150ZA0J | 15 | 850 | 2.0 | 10 | 7 | 8 | 50 | 25 | 750 | 60 | 101 | 240 |
| C44AMGP5200ZA0J | 20 | 850 | 2.6 | 10 | 7 | 6 | 50 | 25 | 1000 | 65 | 101 | 310 |
| C44AMGP5220ZA0J | 22 | 850 | 1.5 | 12 | 5 | 4 | 40 | 25 | 880 | 55 | 138 | 300 |
| C44AMGP5250ZA0J | 25 | 850 | 3.2 | 15 | 7 | 5 | 40 | 25 | 1000 | 55 | 138 | 300 |
| C44AMGP5300ZA0J | 30 | 850 | 3.2 | 15 | 8 | 5 | 40 | 32 | 1200 | 65 | 138 | 380 |
| C44AMGP5330ZA0J | 33 | 850 | 3.2 | 15 | 8 | 5 | 40 | 32 | 1320 | 65 | 138 | 360 |
| C44AMGP5350ZA0J | 35 | 850 | 3.2 | 15 | 10 | 5 | 40 | 32 | 1400 | 65 | 138 | 360 |
| C44AMGP5400ZB0J | 40 | 850 | 3.2 | 15 | 10 | 5 | 40 | 32 | 1600 | 76 | 138 | 580 |
| C44AMGP5500ZA0J | 50 | 850 | 3.2 | 20 | 10 | 5 | 40 | 32 | 2000 | 76 | 138 | 625 |
| C44AMGR5600ZA0J | 60 | 850 | 3.2 | 20 | 10 | 5 | 40 | 32 | 2400 | 85 | 137 | 770 |

MKP Series
ALUMINIUM CASE CAPACITORS
GENERAL PURPOSE APPLICATION
SCREW TERMINALS

PEAK VOLTAGE TABLE

| Un Vdc | U _{PK} Vdc | U _{RMS} Vac |
|-----------|------------------------|-------------------------|
| 1200 | 1600 | 500 |
| 1500 | 2000 | 630 |

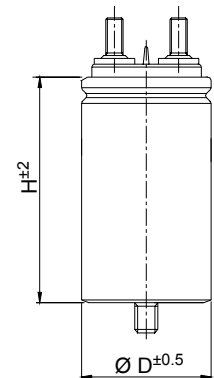

GENERAL CHARACTERISTICS

| Codes | C µF | Un Vdc | K °C/W | Tgδ x 10 ⁻⁴ | | ESR Typ. mΩ | dv/dt V/µs | I _{RMS} A | I _{PKR} A | Case | | Approx Weight g |
|-----------------|---------|-----------|-----------|------------------------|------|-------------------|---------------|-----------------------|-----------------------|------|-----|-----------------------|
| | | | | Max. | Typ. | | | | | D | H | |
| C44APFP4100ZA0J | 1 | 1200 | 17.7 | 5 | 2.5 | 2.5 | 300 | 15 | 300 | 45 | 80 | 135 |
| C44APFP4150ZA0J | 1.5 | 1200 | 17.7 | 5 | 2.5 | 2.5 | 300 | 15 | 450 | 45 | 80 | 135 |
| C44APFP4200ZD0J | 2 | 1200 | 17.7 | 5 | 2.5 | 2.5 | 300 | 15 | 600 | 45 | 80 | 135 |
| C44APFP4220ZA0J | 2.2 | 1200 | 19.5 | 5 | 2.5 | 2 | 300 | 16 | 660 | 45 | 80 | 135 |
| C44APFP4250ZA0J | 2.5 | 1200 | 15.4 | 5 | 2.5 | 2 | 300 | 18 | 750 | 45 | 80 | 135 |
| C44APFP4300ZB0J | 3 | 1200 | 12.5 | 5 | 2.5 | 2 | 300 | 20 | 900 | 50 | 76 | 150 |
| C44APFP4400ZA0J | 4 | 1200 | 12.5 | 5 | 2.5 | 2 | 300 | 20 | 1200 | 50 | 101 | 200 |
| C44APFP4500ZB0J | 5 | 1200 | 10.3 | 5 | 2.5 | 2 | 300 | 22 | 1500 | 50 | 101 | 200 |
| C44APFP4500ZA0J | 5 | 1200 | 3.3 | 5 | 2.5 | 2 | 400 | 40 | 2000 | 50 | 138 | 280 |
| C44APGP4600ZB0J | 6 | 1200 | 8.0 | 5 | 2.5 | 2 | 300 | 25 | 1800 | 55 | 101 | 235 |
| C44APGP4680ZB0J | 6.8 | 1200 | 8.0 | 5 | 2.5 | 2 | 300 | 25 | 2040 | 60 | 101 | 240 |
| C44APGP4750ZF0J | 7.5 | 1200 | 10.6 | 5 | 2.8 | 1.5 | 300 | 25 | 2250 | 50 | 138 | 280 |
| C44APGP4800ZE0J | 8 | 1200 | 4.5 | 5 | 2.8 | 3.5 | 250 | 25 | 2000 | 55 | 138 | 300 |
| C44APGP5100ZE0J | 10 | 1200 | 5.3 | 5 | 2.8 | 3 | 250 | 25 | 2500 | 55 | 138 | 300 |
| C44APGP5100ZF0J | 10 | 1200 | 3.2 | 5 | 2.5 | 2 | 300 | 50 | 3000 | 60 | 138 | 310 |
| C44APGP5100ZH0J | 10 | 1200 | 1.4 | 5 | 2.5 | 2 | 350 | 60 | 3500 | 65 | 158 | 350 |
| C44APGP5125ZA0J | 12.5 | 1200 | 3.2 | 5 | 2.5 | 2 | 300 | 50 | 3750 | 76 | 138 | 625 |
| C44APGP5150ZB0J | 15 | 1200 | 6.4 | 5 | 2.8 | 2.5 | 250 | 32 | 3750 | 76 | 138 | 625 |
| C44APGR5200ZB0J | 20 | 1200 | 6.4 | 5 | 2.8 | 2.5 | 250 | 32 | 5000 | 85 | 137 | 770 |
| C44APGR5220ZA0J | 22 | 1200 | 1.1 | 5 | 2.5 | 2.5 | 300 | 50 | 6600 | 76 | 200 | 940 |
| C44ASFP4100ZA0J | 1 | 1500 | 17.7 | 5 | 2.5 | 2.5 | 400 | 15 | 700 | 45 | 80 | 135 |
| C44ASFP4200ZB0J | 2 | 1500 | 15.6 | 5 | 2.8 | 2.5 | 400 | 16 | 800 | 50 | 76 | 150 |
| C44ASFP4300ZA0J | 3 | 1500 | 10.3 | 5 | 2.8 | 2 | 400 | 22 | 1200 | 50 | 101 | 200 |
| C44ASGP4400ZA0J | 4 | 1500 | 8.0 | 5 | 2.8 | 2 | 400 | 25 | 1600 | 60 | 101 | 265 |
| C44ASGP4500ZB0J | 5 | 1500 | 8.0 | 5 | 2.8 | 2 | 400 | 25 | 2000 | 65 | 101 | 350 |
| C44ASGP4750ZA0J | 7.5 | 1500 | 5.3 | 5 | 2.8 | 3 | 300 | 25 | 2250 | 65 | 138 | 380 |
| C44ASGP5100ZA0J | 10 | 1500 | 5.3 | 5 | 2.8 | 3 | 300 | 32 | 3000 | 70 | 138 | 530 |
| C44ASGR5120ZA0J | 12 | 1500 | 5.3 | 5 | 2.8 | 3 | 300 | 32 | 3600 | 85 | 137 | 770 |
| C44ASGR5150ZA0J | 15 | 1500 | 5.3 | 5 | 2.8 | 3 | 300 | 32 | 4500 | 85 | 137 | 770 |

DRAWINGS

MECHANICAL CHARACTERISTICS

| Case | Brass screw terminals | | | Bolt | | |
|------|-----------------------|-------------------|------------------|------|------|-------------------|
| | Driving Torque Nm | Creepage Distance | Clearance In air | M | H | Driving Torque Nm |
| 45 | 4 | 14 | 10 | M 8 | 10 | 6 |
| 50 | 4 | 14 | 10 | M 8 | 10 | 6 |
| 55 | 4 | 16 | 10 | M 12 | 12.5 | 10 |
| 60 | 4 | 18 | 10 | M 12 | 12.5 | 10 |
| 65 | 4 | 20 | 10 | M 12 | 12.5 | 10 |
| 70 | 4 | 22 | 10 | M 12 | 12.5 | 10 |
| 85 | 7 | 22 | 10 | M 12 | 12.5 | 10 |

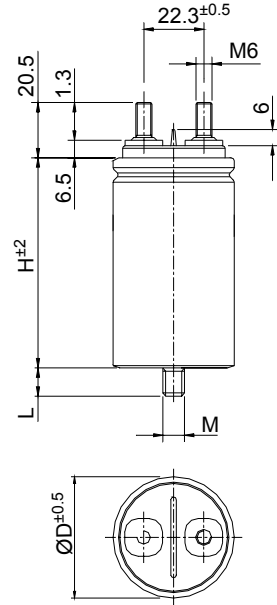

TERMINATIONS

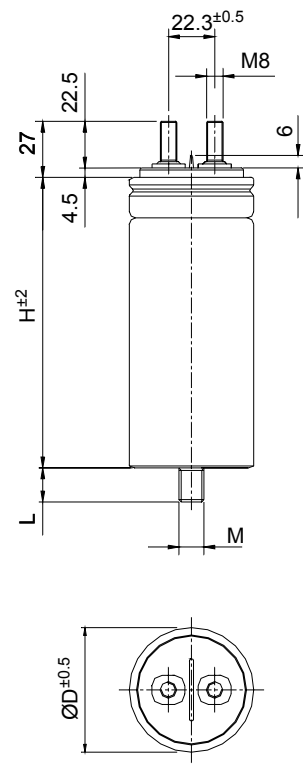
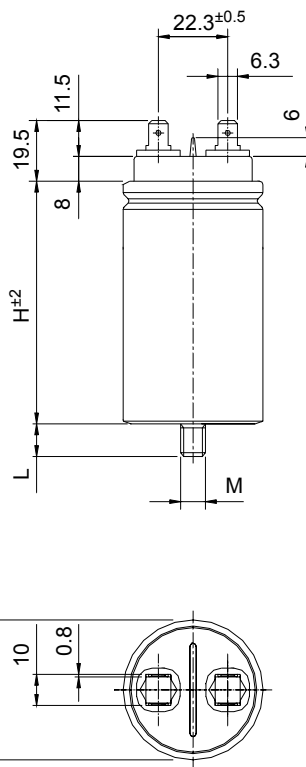
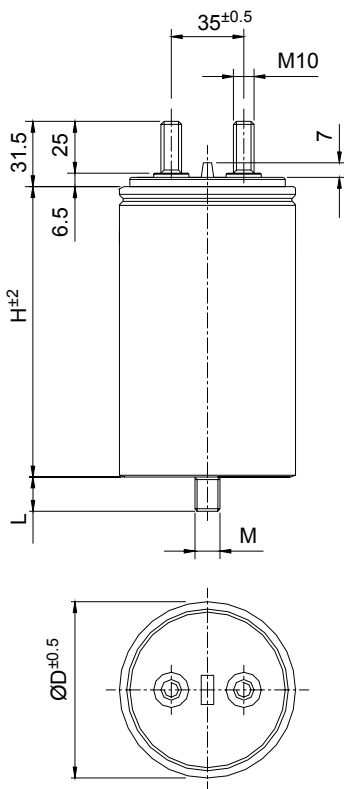

Statements of suitability for certain applications are based on our knowledge of typical operating conditions for such applications, but are not intended to constitute – and we specifically disclaim – any warranty concerning suitability for a specific customer application or use. This Information is intended for use only by customers who have the requisite experience and capability to determine the correct products for their application. Any technical advice inferred from this Information or otherwise provided by us with reference to the use of our products is given gratis, and we assume no obligation or liability for the advice given or results obtained.

Mouser Electronics

Authorized Distributor

Click to View Pricing, Inventory, Delivery & Lifecycle Information:

KEMET:

[C44AFGR6200ZE0J](#) [C44AML5200ZA0J](#) [C44ASF34300ZA0J](#) [C44AHL5500ZB0J](#) [C44AFF35200ZE0K](#)
[C44AZAN3470ZA0J](#) [C44AJG35750ZA0J](#) [C44ARFP4110ZA0J](#)