

## Features

- RoHS lead-free-solder and lead-solder-exempted products are available.
- Input voltage ranges up to 121 VDC
- Voltage withstand test 1500 VAC
- 1 or 2 isolated outputs up to 48 V
- Extremely wide input voltage ranges
- Immunity according to IEC/EN 61000-4-2, -3, -4, -5, -6
- High efficiency (typ. 83%)
- Flexible load distribution on outputs
- Outputs no-load, overload, and short-circuit proof
- High reliability
- Operating ambient temperature  $-40$  to  $+85$  °C
- Thermal protection
- Industrial and alternative pinout
- DIL 24 case with 8.5 mm profile

Safety-approved to IEC 60950-1 2<sup>nd</sup> Ed and CSA/UL 60950-1 2<sup>nd</sup> Ed.



<sup>2</sup> 70IMX4 models

## Description

The IMX4 Series of board-mountable 4-watt DC-DC converters has been designed according to the latest industry requirements and standards. The converters are particularly suitable for use in mobile or stationary applications in transport, industry, or telecom, where variable input voltages or high transient voltages are prevalent.

Covering a total input voltage range from 8.4 VDC up to 121 VDC with three different models, the converters are available with single or dual output from 3.3 up to  $\pm 24$  VDC with flexible load distribution. Features include efficient input and output filtering with unsurpassed transient and surge protection, low output ripple and noise, consistently high efficiency over the entire input voltage range and high reliability as well as excellent dynamic response to load and line changes.

The converters exhibit basic insulation and are designed and

built according to the international safety standards IEC/EN 60950-1 2<sup>nd</sup> Ed. 70IMX4 models are CE-marked.

A special feature is their small case size, DIL 24 with only 8.5 mm profile. The circuit is comprised of integrated planar magnetics, and all components are automatically assembled and solidly soldered onto a single PCB without any wire connection. Thanks to the rigid mechanical design, the converters withstand an extremely high level of shock and vibrations. Careful consideration of possible thermal stresses ensure the absence of hot spots providing long life in environments where temperature cycles are a reality. The thermal design allows operation at full load up to an ambient temperature of 85 °C in free air without using any potting material.

Several options, such as open-frame or an alternative industrial pinout, provide a high level of application-specific engineering and design-in flexibility.

## Table of Contents

	Page		Page
Description .....	1	Electromagnetic Compatibility (EMC) .....	8
Model Selection .....	2	Mechanical Data .....	9
Functional Description .....	3	Immunity to Environmental Conditions .....	10
Electrical Input Data .....	4	Safety and Installation Instructions .....	10
Electrical Output Data .....	6	Description of Options .....	11

Copyright © 2015, Bel Power Solutions Inc. All rights reserved.



## Model Selection

Table 1: Model Selection

Output 1		Output 2		Output power $P_{o \text{ nom}}$ [W]	Input voltage range [VDC]	Efficiency		Model	Options
$V_{o1 \text{ nom}}$ [VDC]	$I_{o1 \text{ nom}}$ [mA] <sup>1</sup>	$V_{o2 \text{ nom}}$ [VDC]	$I_{o2 \text{ nom}}$ [mA] <sup>1</sup>			$\eta_{\text{min}}$ [%]	$\eta_{\text{typ}}$ [%]		
3.3	900	-	-	3.0	8.4 to 36	76	77.5	20IMX4-03-8	Z, G
3.3	900	-	-	3.0	16.8 to 75	76	78	40IMX4-03-8	Z, G
5	700	-	-	3.5	4.7 to 16.8	76	-	5IMX4-05-8	Z, G
5	700	-	-	3.5	8.4 to 36	78	81	20IMX4-05-8	K, Z, G
5	700	-	-	3.5	16.8 to 75	78	81	40IMX4-05-8	K, Z, G
5	700	-	-	3.5	40 to 121	77	78	70IMX4-05-8	G
12	300	-	-	3.6	4.7 to 16.8	79	-	5IMX4-12-8	Z, G
12	340	-	-	4.1	8.4 to 36	78	82	20IMX4-12-8	K, Z, G
12	340	-	-	4.1	16.8 to 75	78	82	40IMX4-12-8	K, Z, G
12	340	-	-	4.1	40 to 121	77	82	70IMX4-12-8	G
15	250	-	-	3.75	4.7 to 16.8	79	-	5IMX4-15-8	Z, G
15	280	-	-	4.2	8.4 to 36	78	82	20IMX4-15-8	K, Z, G
15	280	-	-	4.2	16.8 to 75	78.7	82	40IMX4-15-8	K, Z, G
15	280	-	-	4.2	40 to 121	79	80.5	70IMX4-15-8	G
+5	350	-5	350	3.5	8.4 to 36	77	81	20IMX4-0505-8	K, Z, G
+5	350	-5	350	3.5	16.8 to 75	76	81	40IMX4-0505-8	K, Z, G
+5	350	-5	350	3.5	40 to 121	75.5	78	70IMX4-0505-8	G
+12	170	-12	170	4.1	8.4 to 36	76	82	20IMX4-1212-8	K, Z, G
+12	170	-12	170	4.1	16.8 to 75	76	82	40IMX4-1212-8	K, Z, G
+15	140	-15	140	4.2	8.4 to 36	78	82	20IMX4-1515-8	K, Z, G
+15	140	-15	140	4.2	16.8 to 75	76	82	40IMX4-1515-8	K, Z, G
+24	80	-24	80	3.8	8.4 to 36	76	83	20IMX4-2424-8	Z, G
+24	80	-24	80	3.8	16.8 to 75	76	83	40IMX4-2424-8	Z, G

<sup>1</sup> Flexible load distribution on double-outputs is possible.

Preferred for new designs.

## Part Number Description

Input voltage range  $V_i$

4.7 to 16.8 VDC ..... 5  
 8.4 to 36 VDC ..... 20  
 16.8 to 75 VDC ..... 40  
 40 to 121 VDC ..... 70

Series ..... IMX4

Output voltage of output 1 ..... 03, 05, 12, 15, 24

Output voltage of output 2 ..... 05, 12, 15, 24

Operating ambient temperature range -40 to 85 °C ..... -8

Options: Alternative pinout ..... K  
 Open frame ..... Z  
 RoHS compliant for all six substances ..... G

20 IMX4 - 05 05 -8 K Z G

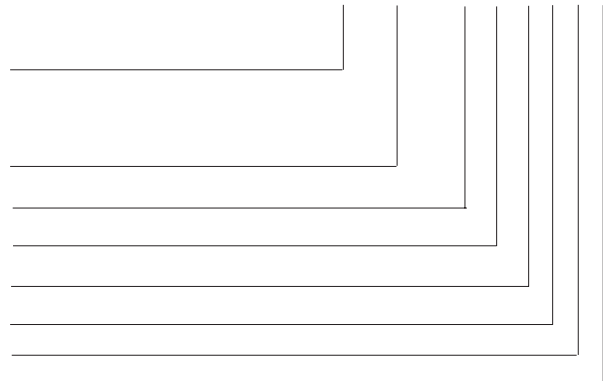

**Note:** The sequence of options must follow the order above. This part number description is descriptive only; it is not intended for creating part numbers.

**Example:** 40IMX4-0505-8KG: DC-DC converter, input voltage range 16.8 to 75 V, 2 outputs providing  $\pm 5$  V, 350 mA, temperature range -40 to 85 °C, alternative pinout, RoHS-compliant for all six substances

## Functional Description

The IMX4 Series converters are feedback-controlled flyback converters using current mode PWM (Pulse Width Modulation). The input is protected against transients by means of a suppressor diode.

The output voltage is monitored by a separate transformer winding close to the secondary windings and fed back to the control circuit.

Current limitation is provided by the primary circuit, thus limiting the total output current ( $I_{o\ nom}$  for single- and the sum  $I_{o1\ nom} + I_{o2\ nom}$  for dual-output models).

The close magnetic coupling provided by the planar construction ensures very good regulation and allows for flexible load distribution on dual-output models.

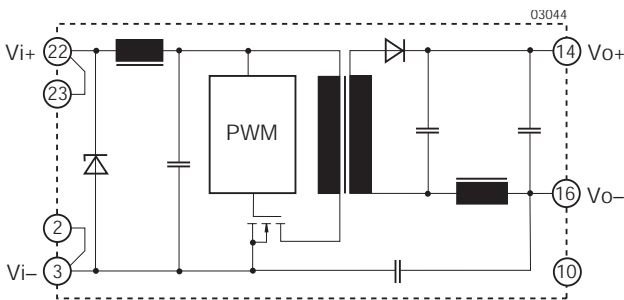

**Fig. 1**  
Block diagram for single-output models with standard pinout.

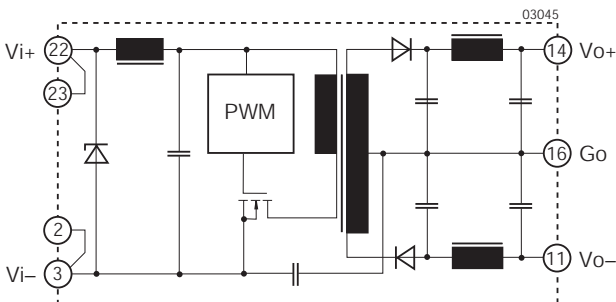

**Fig. 2**  
Block diagram for dual-output models with standard pinout.

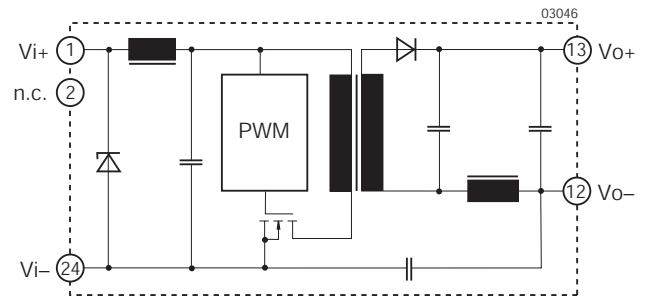

**Fig. 3**  
Block diagram for single-output models with alternative pinout (option K).

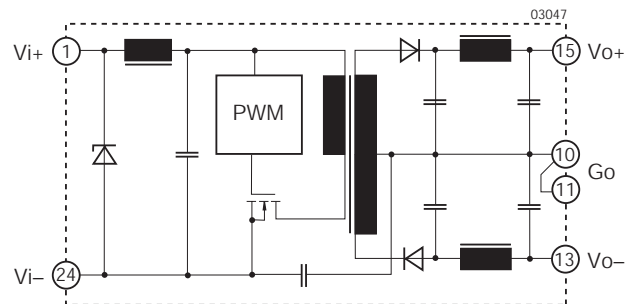

**Fig. 4**  
Block diagram for dual-output models with alternative pinout (option K).

## Electrical Input Data

General conditions:  $T_A = 25\text{ }^\circ\text{C}$ , unless  $T_C$  is specified.

Table 2: Input Data

Input			5IMX4			20IMX4			40IMX4			70IMX4			Unit
Characteristics		Conditions	min	typ	max	min	typ	max	min	typ	max	min	typ	max	
$V_i$	Input voltage range	$T_C \text{ min to } T_C \text{ max}$	4.7	5.0	16.8	8.4	36	16.8 <sup>2</sup>	75	40	121				VDC
$V_{i \text{ nom}}$	Nominal input voltage	$I_o = 0$ to $I_o \text{ nom}$	5.0			20			40			70			
$V_{i \text{ sur}}$	Repetitive surge voltage	abs. max input (3 s)	--			40			100			150			
$t_{\text{start-up}}$	Converter start-up time <sup>1</sup>	Worst case condition at $V_{i \text{ min}}$ and full load	0.25	0.5		0.25	0.5		0.25	0.5		0.3	0.6		s
$t_{\text{rise}}$	Rise time <sup>1</sup>	$V_{i \text{ nom}}$ resistive load	--			5			5			5			ms
		$I_o \text{ nom}$ capacitive load	--			12			12			12			
$I_{i \text{ o}}$	No-load input current	$I_o = 0$ , $V_{i \text{ min}}$ to $V_{i \text{ max}}$	--			15 20			5 10			5 10			mA
$C_i$	Input capacitance		--			0.54			0.3			0.15			$\mu\text{F}$
$I_{\text{inr p}}$	Inrush peak current	$V_i = V_{i \text{ nom}}^3$	3.8			3.7			4.2			5.6			A
$f_s$	Switching frequency	$V_{i \text{ min}}$ to $V_{i \text{ max}}$ , $I_o = 0$ to $I_o \text{ nom}$	400			400			400			400			kHz
$I_{i \text{ rr}}$	Reflected ripple current	$I_o = 0$ to $I_o \text{ nom}$	--			100			60			30			$\text{mA}_{\text{pp}}$
$V_{i \text{ RFI}}$	Input RFI level conducted	EN 55011/55022 <sup>4</sup>	--			A			A			A			Class

<sup>1</sup> Measured with a resistive or max. admissible capacitive load; see fig. 5

<sup>2</sup> Operation at lower input voltage possible:  $P_o$  approx. 80% of  $P_{o \text{ nom}}$  at  $V_{i \text{ min}} = 14.4\text{ V}$

<sup>3</sup> Source impedance according to ETS 300132-2, version 4.3.

<sup>4</sup> External capacitors required according to table 3.

### Start-up

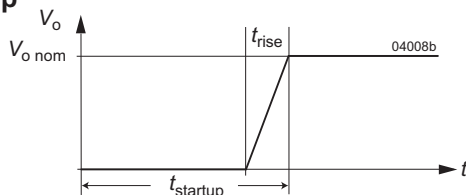

Fig. 5

Converter start-up and rise time

### Inrush Current

The inrush current has been kept as low as possible by choosing a very small input capacitance. A series resistor may be inserted in the input line to further limit this current.

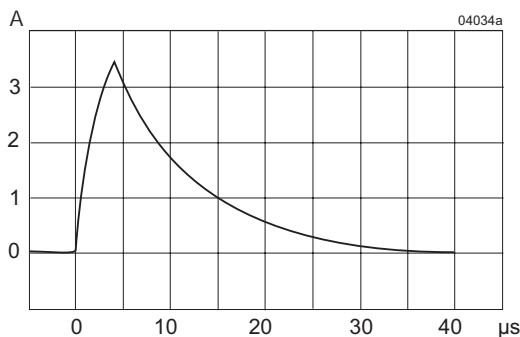

Fig. 6

Typ. inrush current at  $V_{i \text{ nom}}$ ,  $P_{o \text{ nom}}$  versus time measured according to ETS 300132-2, version 4.3 (40IMX4).

### Filter to Comply with EN 55011/55022

Electromagnetic emission requirements according to table *Electrical Input Data* can be achieved by adding an external capacitor as close as possible to the input terminals (see fig. 7 and table 3).

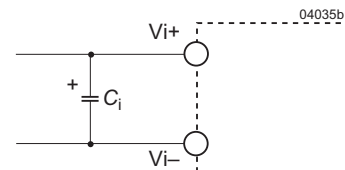

Fig. 7

Input capacitors

Table 3: Input electrolytic capacitors

Model	20IMX4	40IMX4	70IMX4
$C_i$	100 $\mu\text{F}$ 50 V	47 $\mu\text{F}$ 100 V	330 $\mu\text{F}$ 200 V

### Input Transient Voltage Protection

In many applications transient voltages on the converter input are always possible. These may be caused for example by short circuits between  $V_{i+}$  and  $V_{i-}$ , where the network inductance may generate high energy pulses.

In order to protect the converter, a transient voltage suppressor diode is fitted at the input; see table below.

Table 4: Built-in transient voltage suppressor

Model	Breakdown voltage $V_{BR\ nom}$	Peak power at 1 ms $P_P$	Peak pulse current $I_{PP}$
5IMX4	--	--	--
20IMX4	40 V	600 W	10.3 A
40IMX4	100 V	600 W	4.1 A
70IMX4	150 V	600 W	2.9 A

If transients generating currents above the peak pulse current  $I_{PP}$  are possible, an external limiting network such as the circuit shown in figure 8 is recommended. It provides compliance with transients according to IEC/EN 61000-4-5, level 2. The components are specified in table 5.

If 40IMX4 converters should withstand 150 V transients according to 19Pfl1, the same external circuitry with similar components as shown in figure 8 can be used.

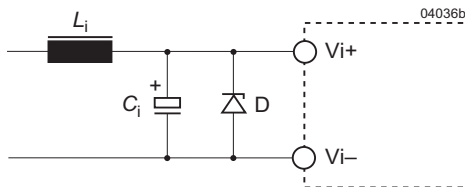

Fig. 8

External circuitry to comply with IEC/EN 61000-4-5, level 2.

Table 5: Components for the circuitry fig. 8

Model	20IMX4	40IMX4	70IMX4
$L_i$	330 $\mu$ H, 0.42 W 1 A	330 $\mu$ H, 0.42 W 0.6 A	330 $\mu$ H, 0.65 W 0.3 A
$C_i$	68 $\mu$ F, 50 V	68 $\mu$ F, 100 V	100 $\mu$ F, 200 V
D	ON 1.5KE 39 A	ON 1.5KE 82 A	—

### Fuse and Reverse Polarity Protection

The suppressor diode on the input also protects against reverse polarity input voltage. An external fast fuse is required to limit this reverse current; see table below.

Table 6: External input fuse

Model	Fuse type
5IMX4	Fast 1.6 A
20IMX4	Fast 1 A
40IMX4	Fast 0.5 A
70IMX4	Fast 0.315 A

## Electrical Output Data

General conditions:  $T_A = 25\text{ °C}$ , unless  $T_C$  is specified.

Table 7a: Output data for single-output models

Output		$V_o$ nom	3.3 V			5 V			12 V			15 V		Unit	
Characteristics		Conditions	min	typ	max	min	typ	max	min	typ	max	min	typ	max	
$V_o$	Output setting voltage	$V_{i\text{ nom}}, I_o = 0.5 I_{o\text{ nom}}$	3.27		3.33	4.96		5.04	11.90		12.10	14.88		15.12	V
$I_{o\text{ nom}}$	Output current (nom.)	$V_{i\text{ min}}$ to $V_{i\text{ max}}$ 5IMX4	--			700			300			250		mA	
		others	900			700			340			280			
$I_{o\text{ L}}$	Current limit <sup>2</sup>	$V_{i\text{ nom}}$ 5IMX4	950			1000			375			325			
		others	1260		1800	955		1400	476		680	392			560
$\Delta V_{oV}$	Line regulation	$V_{i\text{ min}}$ to $V_{i\text{ max}}, I_{o\text{ nom}}$				$\pm 1$			$\pm 1$			$\pm 1$		%	
$\Delta V$	Load regulation	$V_{i\text{ nom}}$ $I_o = (0.1 \text{ to } 1) I_{o\text{ nom}}$				$\pm 3.5$			$\pm 3$			$\pm 3$			
$v_o$	Output voltage noise	$V_{i\text{ min}}$ to $V_{i\text{ max}}$ <sup>5</sup> $I_o = I_{o\text{ nom}}$ <sup>6</sup>	80			80			120			150		mV <sub>pp</sub>	
			20		40	20		40	40		60	50			75
$V_{o\text{ clip}}$	Output overvoltage limitation	Min. load 1%	130			130			130			130		%	
$C_{o\text{ ext}}$	Admissible capacitive load		0		680	0		680	0		150	0		100	$\mu\text{F}$
$V_{o\text{ d}}$	Dynamic load regulat.	Voltage deviat. Recovery time	$V_{i\text{ nom}}$ $I_o = (1 \text{ to } 0.5) I_{o\text{ nom}}$			$\pm 250$			$\pm 250$			$\pm 250$		mV	
$t_d$				1			1			1			1		ms
$\alpha_{V_o}$	Temperature coefficient $\Delta V_o/\Delta T_C$	$V_{i\text{ min}}$ to $V_{i\text{ max}}$ $I_o = (0.1 \text{ to } 1) I_{o\text{ nom}}$	$\pm 0.02$			$\pm 0.02$			$\pm 0.02$			$\pm 0.02$		%/K	

Table 7b: Output data for dual-output models

Output		$V_o$ nom	$\pm 5\text{ V}$			$\pm 12\text{ V}$			$\pm 15\text{ V}$			$\pm 24\text{ V}$		Unit	
Characteristics		Conditions	min	typ	max	min	typ	max	min	typ	max	min	typ	max	
$V_{o1}$ $V_{o2}$	Output setting voltage	$V_{i\text{ nom}}$ $I_{o1} = I_{o2} = 0.5 I_{o\text{ nom}}$	4.96		5.04	11.90		12.10	14.88		15.12	23.81		24.19	V
			4.95		5.05	11.88		12.12	14.85		15.15	23.75		24.25	
$I_{o\text{ nom}}$	Output current (nom.) <sup>1</sup>	$V_{i\text{ min}}$ to $V_{i\text{ max}}$	2 x 350			2 x 170			2 x 140			2 x 80		mA	
$I_{o\text{ L}}$	Current limit <sup>2 3</sup>	$V_{i\text{ nom}}, T_C = 25\text{ °C}$	1000			474			392			232			
$\Delta V_{oV}$	Line regulation	$V_{i\text{ min}}$ to $V_{i\text{ max}}, I_{o\text{ nom}}$				$\pm 1$			$\pm 1$			$\pm 1$		%	
$\Delta V$	Load regulation <sup>4</sup>	$V_{i\text{ nom}}$ $I_o = (0.1 \text{ to } 1) I_{o\text{ nom}}$				$\pm 3$			$\pm 3.5$			$\pm 3$			
$v_{o1,2}$	Output voltage noise	$V_{i\text{ min}}$ to $V_{i\text{ max}}$ <sup>5</sup> $I_o = I_{o\text{ nom}}$ <sup>6</sup>	100			140			150			240		mV <sub>pp</sub>	
			40		60	45		70	50		75	40			120
$V_{o\text{ clip}}$	Output overvoltage limitation	Min. load 1%	130			130			130			130		%	
$C_{o\text{ ext}}$	Admissible capacitive load <sup>3</sup>		0		680	0		150	0		100	0		47	$\mu\text{F}$
$V_{o\text{ d}}$	Dynamic load regulat.	Voltage deviat. Recovery time	$V_{i\text{ nom}}$ $I_o = (1 \text{ to } 0.5) I_{o\text{ nom}}$			$\pm 250$			$\pm 600$			$\pm 750$		mV	
$t_d$				1			1			1			1		ms
$\alpha_{V_o}$	Temperature coefficient $\Delta V_o/\Delta T_C$	$V_{i\text{ min}}$ to $V_{i\text{ max}}$ $I_o = (0.1 \text{ to } 1) I_{o\text{ nom}}$	$\pm 0.02$			$\pm 0.02$			$\pm 0.02$			$\pm 0.02$		%/K	

<sup>1</sup> Each output is capable of delivering full output power.

<sup>2</sup> The current limit is primary side controlled.

<sup>3</sup> Sum of both outputs

<sup>4</sup> Conditions for specified output. Other output loaded with constant current  $I_o = 0.5 I_{o\text{ nom}}$ .

<sup>5</sup> BW = 20 MHz

<sup>6</sup> Measured with a probe according to EN 61204

### Thermal Considerations

If a converter, mounted on a PCB, is located in free, quasi-stationary air (convection cooling) at the maximum ambient temperature  $T_{A \max}$  (see table *Temperature specifications*) and is operated at nominal input voltage and output power, the case temperature  $T_C$  measured at the measuring point of case temperature  $T_C$  (see *Mechanical Data*) will approach the indicated value  $T_{C \max}$  after the warm-up phase. However, the relationship between  $T_A$  and  $T_C$  depends heavily on the conditions of operation and integration into a system. The thermal conditions depend on input voltage, output current, airflow, temperature of surrounding components and surfaces and the properties of the printed circuit board.  $T_{A \max}$  is therefore only an indicative value, and under practical operating conditions, the ambient temperature  $T_A$  may be higher or lower.

**Caution:** The case temperature  $T_C$  measured at the measuring point of case temperature  $T_C$  (see *Mechanical Data*) may under no circumstances exceed the specified maximum. The installer must ensure that under all operating conditions  $T_C$  remains within the limits stated in the table *Temperature Specifications*.

### Short Circuit Behavior

The current limitation shuts down the converter, when a short circuit is applied to the output. It acts self-protecting, and automatically recovers after removal of the overload condition.

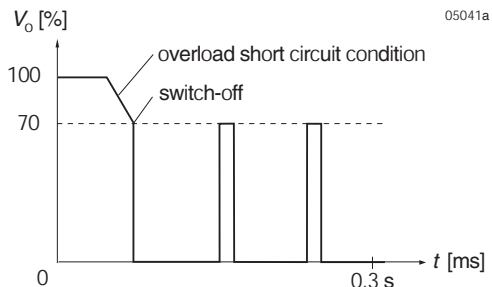

Fig. 9  
Overload switch-off (hiccup mode).

### Output Overvoltage Protection

The outputs are protected against overvoltages by Zener diodes. In the event of an overvoltage, the converter will shut-down and attempt to restart automatically. The main purpose of this feature is to protect against possible overvoltages, which could occur due to a failure in the feedback control circuit. The converters are not designed to withstand external overvoltages applied to the outputs.

### Connection in Series

The outputs of single or dual-output models can be connected in series without any precautions, taking into consideration that the output voltage should remain below 60 V for SELV operation.

### Connection in Parallel

Several converters with equal output voltage can be connected in parallel and will share their output current quite equally. However, this may cause start-up problems and is only recommended in applications, where one converter is able to deliver the full load current, e.g., in true redundant systems.

### Typical Performance Curves

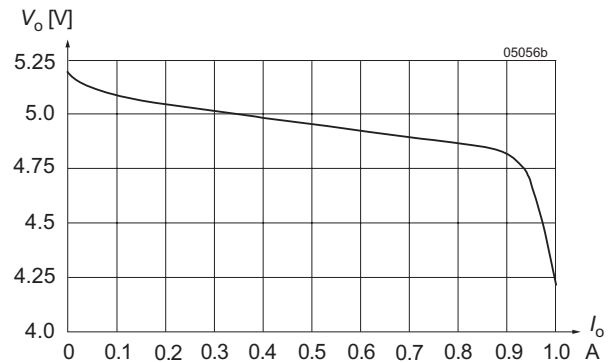

Fig. 10  
 $V_o$  versus  $I_o$  (typ) of single-output models (20IMX4-05)

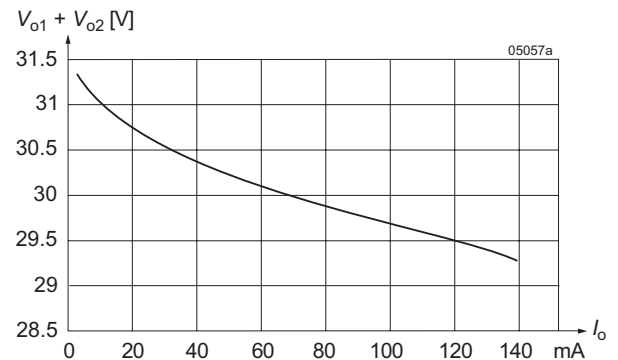

Fig. 11  
 $V_o$  versus  $I_o$  (typ.) of dual-output models ( $\pm 15$  V), with load connected between  $V_{o+}$  and  $V_{o-}$ .

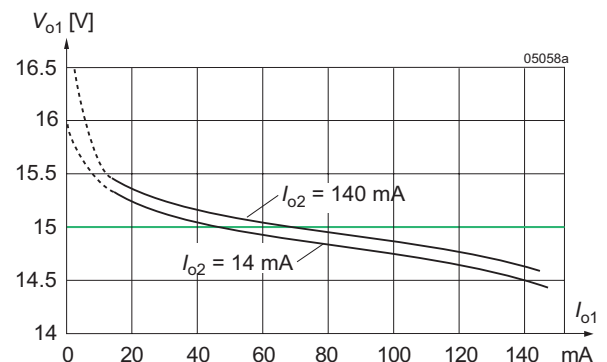
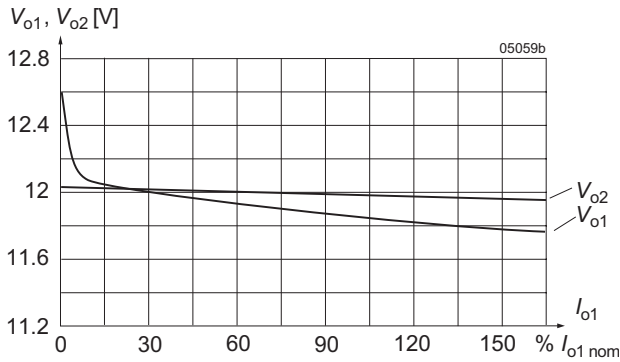
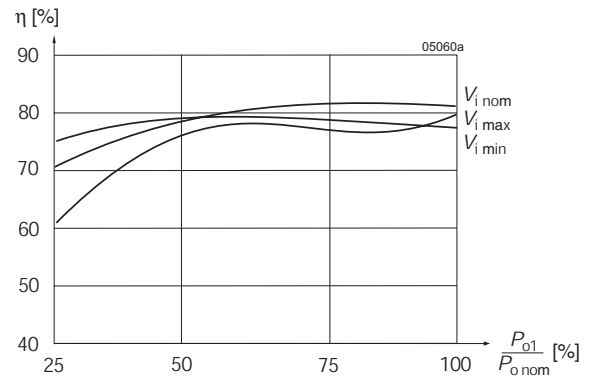

Fig. 12  
Cross load regulation of dual-output models.  $V_{o1}$  versus  $I_{o1}$  (typ) for various  $I_{o2}$  (40IMX4-1515).



**Fig. 13**  
 Flexible load distribution on dual outputs ( $2 \times 12\text{ V}$ ) with load variation from 0 to 150% of  $P_{o1\text{ nom}}$  on output 1. Output 2 loaded with 25% of  $P_{o2\text{ nom}}$ .



**Fig. 14**  
 Efficiency versus input voltage and load. Typical values (40IMX4-1212).

## Electromagnetic Compatibility (EMC)

### Electromagnetic Immunity

Table 8: Immunity type tests

Phenomenon	Standard	Class level	Coupling mode	Value applied	Waveform	Source imped.	Test procedure	In oper.	Per-form. <sup>2</sup>
Electrostatic discharge to case	IEC/EN 61000-4-2	2	contact discharge	$4000\text{ V}_p$	1/50 ns	330 Ω	10 positive and 10 negative discharges	yes	B
		3	air discharge	$8000\text{ V}_p$					
Electromagnetic field	IEC/EN 61000-4-3	3 <sup>3</sup>	antenna	10 V/m	AM 80% 1 kHz	n.a.	80 – 1000 MHz	yes	A
		3	antenna	10 V/m	PM, 50% duty cycle, 200 Hz repetition frequ.	n.a.	900 MHz	yes	A
Electrical fast transients/burst	IEC/EN 61000-4-4	4	direct +i/-i	$\pm 4000\text{ V}_p$	bursts of 5/50 ns 5 kHz repet. rate, 15 ms burst, 300 ms period	50 Ω	60 s positive 60 s negative coupling mode	yes	B
Surges	IEC/EN 61000-4-5	2 <sup>4</sup>	+i/-i	$1000\text{ V}_p$	1.2/50 μs	2 Ω	5 pos. and 5 neg. surges	yes	B
RF conducted immunity	IEC/EN 61000-4-6	3	+i/-i	3 VAC (140 dBμV)	AM 80% 1 kHz	50 Ω	0.15 to 80 MHz 150 W	yes	A

<sup>1</sup> i = input, o = output

<sup>2</sup> Performance criterion: A = normal operation, no deviation from specifications, B = temporary loss of function or deviation from specs.

<sup>3</sup> Corresponds to the railway standard EN 50121-3-2:2000, table 9.1

<sup>4</sup> External components required.



### Electromagnetic Emission

Conducted RFI noise at input according to EN 55011/55022

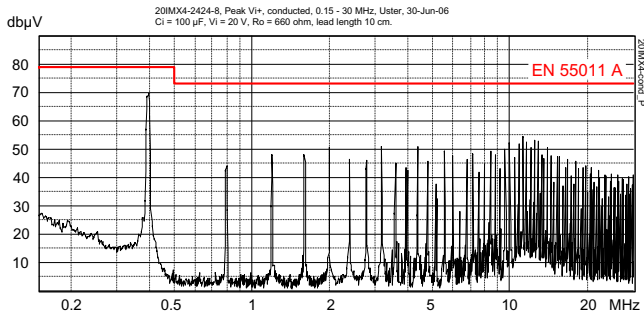

**Fig. 15a**  
Typical disturbance voltage (peak) at the pos. input according to EN 55011/55022, measured at V<sub>i nom</sub> and I<sub>o nom</sub>.  
Output leads 0.1 m, twisted. Input capacitors see table 3.  
(20IMX4-2424-8).

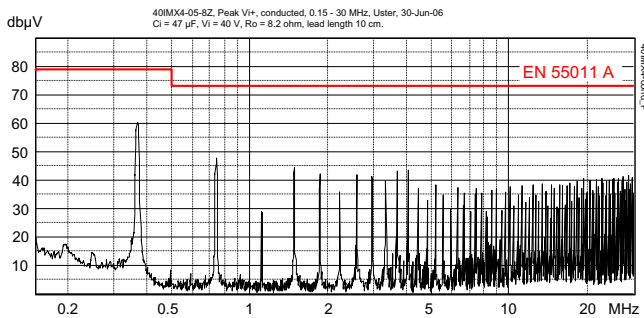

**Fig. 15b**  
Typical disturbance voltage (peak) at the pos. input according to EN 55011/55022, measured at V<sub>i nom</sub> and I<sub>o nom</sub>.  
Output leads 0.1 m, twisted. Input capacitors see table 3.  
(40IMX4-05-8Z).

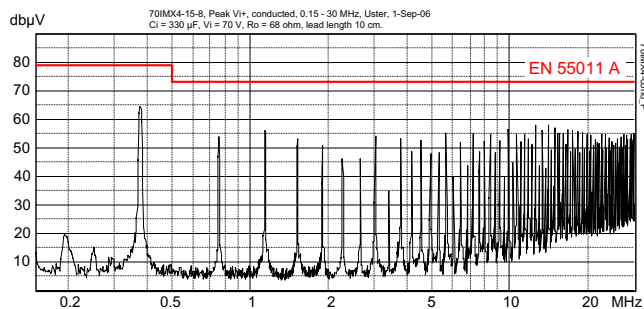

**Fig. 15c**  
Typical disturbance voltage (peak) at the pos. input according to EN 55011/55022, measured at V<sub>i nom</sub> and I<sub>o nom</sub>.  
Output leads 0.1 m, twisted. Input capacitors see table 3.

### Mechanical Data

Dimensions in mm (inches).  
Tolerances ±0.3 mm, unless noted

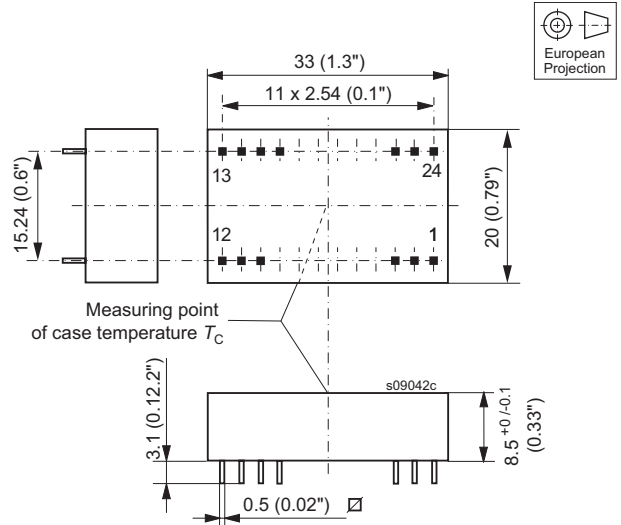

**Fig. 16**  
Case with standard or alternative pinout (option K)  
Material: Fortron black; weight: <10 g

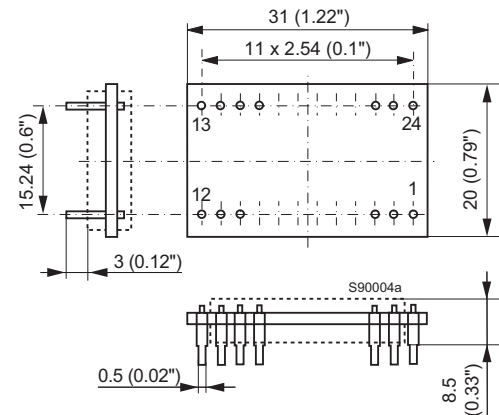

**Fig. 17**  
Open frame (option Z)  
Weight: <10 g

## Immunity to Environmental Conditions

Table 9: Mechanical and climatic stress

Test Method		Standard	Test conditions	Status
Ca	Damp heat steady state	IEC/EN 60068-2-78 MIL-STD-810D section 507.2	Temperature: 40 ±2 °C Relative humidity: 93 <sup>+2/-3</sup> % Duration: 56 days	Converter not operating
Ea	Shock (half-sinusoidal)	IEC/EN 60068-2-27 <sup>1</sup> MIL-STD-810D section 516.3	Acceleration amplitude: 100 g <sub>n</sub> = 981 m/s <sup>2</sup> Bump duration: 6 ms Number of bumps: 18 (3 each direction)	Converter operating
Eb	Bump (half-sinusoidal)	IEC/EN 60068-2-29 MIL-STD-810D section 516.3	Acceleration amplitude: 40 g <sub>n</sub> = 392 m/s <sup>2</sup> Bump duration: 6 ms Number of bumps: 6000 (1000 each direction)	Converter operating
Fc	Vibration (sinusoidal)	IEC/EN 60068-2-6	Acceleration amplitude: 0.35 mm (10 to 60 Hz) 5 g <sub>n</sub> = 49 m/s <sup>2</sup> (60 to 2000 Hz) Frequency (1 Oct/min): 10 to 2000 Hz Test duration: 7.5 h (2.5 h each axis)	Converter operating
Fh	Vibration, broad-band random (digital control)	IEC/EN 60068-2-64	Acceleration spectral density: 0.05 g <sub>n</sub> <sup>2</sup> /Hz Frequency band: 10 to 500 Hz Acceleration magnitude: 4.9 g <sub>n rms</sub> Test duration: 3 h (1 h each axis)	Converter operating
Kb	Salt mist, cyclic (sodium chloride NaCl solution)	IEC/EN 60068-2-52	Concentration: 5% (30 °C) Duration: 2 h per cycle Storage: 40 °C, 93% rel. humidity Cycles and storage duration: 3 days, 22 h per cycle	Converter not operating

<sup>1</sup> Covers also EN 50155/EN 61373 category 1, class B, body mounted (= chassis of coach)

## Temperatures

Table 10: Temperature specifications, valid for air pressure of 800 to 1200 hPa (800 to 1200 mbar)

Temperature		Standard (-8)	Unit		
Characteristics	Conditions			min	max
T <sub>A</sub>	Ambient temperature	Operational <sup>1</sup>	-40	85	°C
T <sub>C</sub>	Case temperature		-40	105	
T <sub>S</sub>	Storage temperature	Non operational	-55	105	

<sup>1</sup> See *Thermal Considerations*

## Failure Rates

Table 11: MTBF

MTBF	Ground benign T <sub>C</sub> = 40 °C	Ground fixed		Ground mobile T <sub>C</sub> = 50 °C	Unit
		T <sub>C</sub> = 40 °C	T <sub>C</sub> = 70 °C		
40IMX4-05-8 (MIL-HDBK-217F)	890 000	440 000	247 000	362 000	h
40IMX4-1212-8 (Bellcore)	3 535 000	1 768 000	917 000	476 000	

## Safety and Installation Instructions

### Installation Instruction

Installation of the dc-dc converters must strictly follow the national safety regulations in compliance with the enclosure, mounting, creepage, clearance, casualty, markings and segregation requirements of the end-use application.

Connection to the system shall be made via a printed circuit board; see *Mechanical Data*.

The converters should be connected to a secondary circuit.

Do not open the converter.

Ensure that a converter failure does not result in a hazardous condition.

To prevent excessive current flowing through the input lines in case of a short-circuit, an external fuse specified in table 6 should be installed in the non-earthed input supply line.

### Pin Allocation

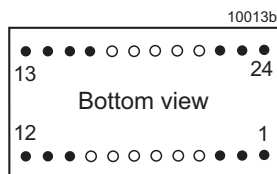

Fig. 18  
Foot print

Table 12: Pin allocation for standard and option Z

Pin	Single-output models	Dual-output models
2	Vi-	Vi-
3	Vi-	Vi-
10	n.c.	--
11	--	Vo-
14	Vo+	Vo+
16	Vo-	Go
22	Vi+	Vi+
23	Vi+	Vi+

Table 13: Pin allocation for option K

Pin	Single-output models	Dual-output models
1	Vi+	Vi+
2	n.c.	--
10	--	Go
11	--	Go
12	Vo-	--
13	Vo+	Vo-
15	--	Vo+
24	Vi-	Vi-

## Standards and Approvals

The converters are approved according to UL/CSA 60950-1 and IEC/EN 60950-1 2<sup>nd</sup> Edition.

The converters have been evaluated for:

- Building-in
- Basic insulation input to output, based on their maximum input voltage
- Pollution degree 2 environment
- Connecting the input to a secondary circuit, which is subject to a maximum transient rating of 1500 V for 20IMX4 and 40IMX4, and 2000 V for 70IMX4 models.

The converters are subject to manufacturing surveillance in accordance with the above mentioned standards and with ISO 9001:2008.

## Railway Applications

To comply with railway standards, all components are coated with a protective lacquer (except option Z).

## Protection Degree and Cleaning Liquids

The protection degree of the converters (except opt. Z) is IP 40 for models with Revision BA (or later). Older models have IP 30.

In order to avoid possible damage, any penetration of cleaning fluids should be prevented, since the power supplies are not hermetically sealed.

However, open-frame models (option Z) leave the factory unlacquered; they may be lacquered by the customer, for instance together with the mother board. Cleaning agents are not permitted – except washing at room temperature with isopropyl alcohol. If necessary, the mother board must be cleaned, before fitting the open-frame converter.

**Note:** Cleaning liquids may damage the adhesive joints of the ferrite cores.

## Isolation

The electric strength test is performed in the factory as a routine test in accordance with EN 50514 and IEC/EN 60950. The Company will not honor any warranty claims resulting from incorrectly executed electric strength field tests.

Table 14: Electric strength test voltages

Characteristic	Input to output			Unit
	5IMX4	20/40IMX4	70IMX4	
Factory test >1 s	0.77	1.5 <sup>1</sup>	1.5	kVAC
Equivalent DC test voltage	1.0	2.0 <sup>1</sup>	2.0	kVDC
Coupling capacitance	2.2	typ. 1.1	typ. 1.1	nF
Insulation resist. (500 VDC)	--	>100	>100	MΩ

<sup>1</sup> Converters produced 2013 or later; older units were tested with 1.2 kVAC.

## Description of Options

### Option K: Alternative Pinout

This pinout is compatible with other converters on the market.

### Option Z: Open Frame

For applications, where the protection of the case is not necessary or in the case that the motherboard should be cleaned and lacquered with the converter fitted.

### Option G: RoHS-6

Converters with a type designation ending with G are RoHS-compliant for all six substances.

---

NUCLEAR AND MEDICAL APPLICATIONS - These products are not designed or intended for use as critical components in life support systems, equipment used in hazardous environments, or nuclear control systems.

TECHNICAL REVISIONS - The appearance of products, including safety agency certifications pictured on labels, may change depending on the date manufactured. Specifications are subject to change without notice.

Copyright © 2015, Bel Power Solutions Inc. All rights reserved.

[www.belpowersolutions.com/power](http://www.belpowersolutions.com/power)