

External GPS/GLONASS + LTE MIMO + WiFi MIMO Antenna



AEACBK110053-MLWG



Ø110.0 x 53.0 mm
RoHS/RoHS II Compliant
MSL = 1

Features

- 2 x 4G/LTE
- 2 x WiFi 2.4/5.5 GHz
- Active GPS/GLONASS
- Active GNSS with LNA gain of 28 dB
- RHCP for GNSS
- Linear polarized LTE and WiFi
- IP67 rated
- Screw mount

Applications

- 4G/LTE/3G/2G/GSM applications
- GNSS/GPS/GLONASS
- Gateways and routers
- WiFi 2.4/5.5 GHz
- Telematics
- M2M
- IoT and Industrial IoT
- Geolocation and tracking
- Transportation and agriculture
- Smart city

Electrical Characteristics

| Parameters | Min. | Typ. | Max | Units | Note |
|---|--------|-----------------------------------|-----|-------|------|
| LTE MIMO Antenna | | | | | |
| Frequency Range | | 698-960/1710-2690 | | MHz | |
| VSWR | | | 3.0 | | |
| Polarization | Linear | | | | |
| Impedance | | 50 | | Ω | |
| Gain | | 3.0 | | dBi | |
| GNSS (GPS & GLONASS) Antenna | | | | | |
| Center Frequency | | 1575.42-1610 | | MHz | |
| Polarization | | RHCP | | | |
| Impedance | | 50 | | | |
| Dimension | | 25.0 x 25.0 x 6.0 | | mm | |
| GNSS LNA | | | | | |
| Gain | | 28±2 | | dB | |
| Noise Figure | | | 1.5 | dB | |
| VSWR | | | 2.0 | | |
| Supply Voltage | 3.0 | | 5.0 | V | DC |
| Current Consumption | | | 15 | mA | |
| WiFi MIMO Antenna | | | | | |
| Frequency Range | | 2400-2483.5MHz/ 4900 - 5825MHz | | MHz | |
| VSWR | | | 2.5 | | |
| Polarization | Linear | | | | |
| Impedance | | 50 | | Ω | |
| Gain | | 2.0 | | dBi | |

External GPS/GLONASS + LTE MIMO + WiFi MIMO Antenna



AEACBK110053-MLWG



Ø110.0 x 53.0 mm
RoHS/RoHS II Compliant
MSL = 1

Mechanical Characteristics

| Parameters | Description |
|-----------------|------------------|
| Connector | SMA Male |
| Cable Type | RG174 |
| Cable Length | 3M |
| Radome Material | ABS |
| Mounting Method | Screw |
| Dimensions | Φ110.0 x 53.0 mm |

Environmental Characteristics

| Parameters | Description |
|-----------------------|---|
| Waterproof | IP67 (exclude cable outlet) |
| Operating Temperature | -40 ~ +85°C |
| Relative Humidity | Up to 95% |
| MSL Level | 1 |
| ROHS Complaint | Yes |
| Vibration | 10 to 55Hz with 1.5mm amplitude 2 hours |

Dimensions

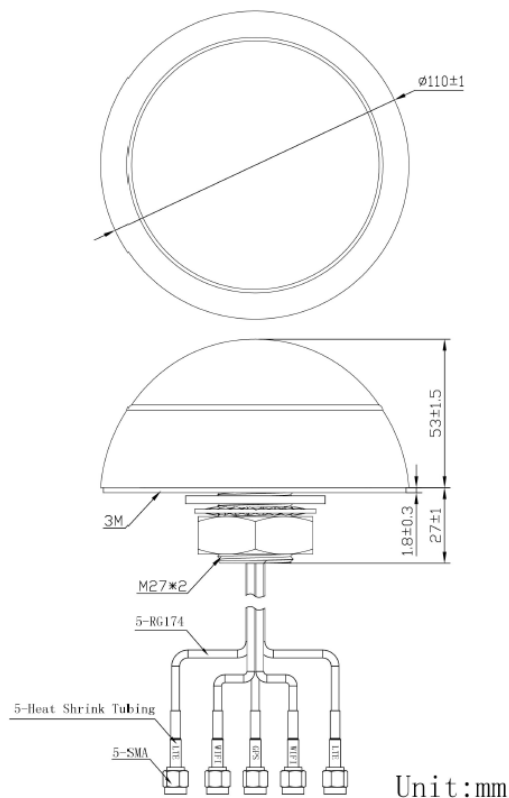

External GPS/GLONASS + LTE MIMO + WiFi MIMO Antenna



AEACBK110053-MLWG



Ø110.0 x 53.0 mm
RoHS/RoHS II Compliant
MSL = 1

Product Image



VSWR Characteristics

LTE

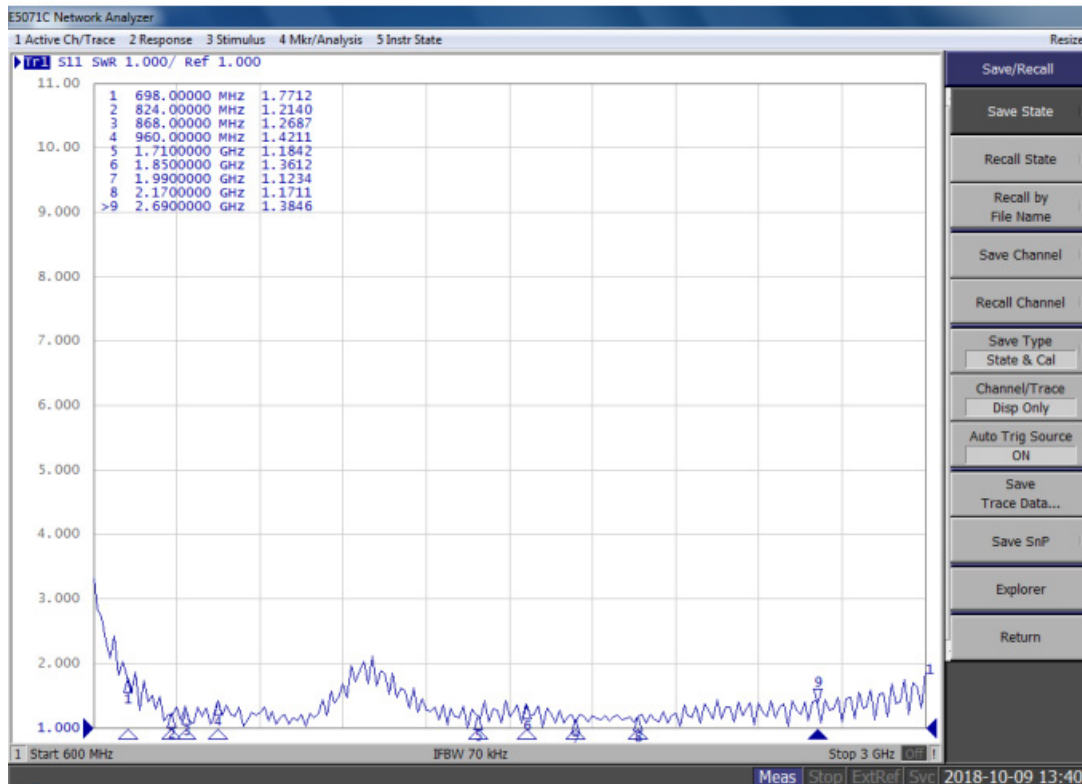

External GPS/GLONASS + LTE MIMO + WiFi MIMO Antenna



AEACBK110053-MLWG



Ø110.0 x 53.0 mm
RoHS/RoHS II Compliant
MSL = 1

VSWR Characteristics

WiFi

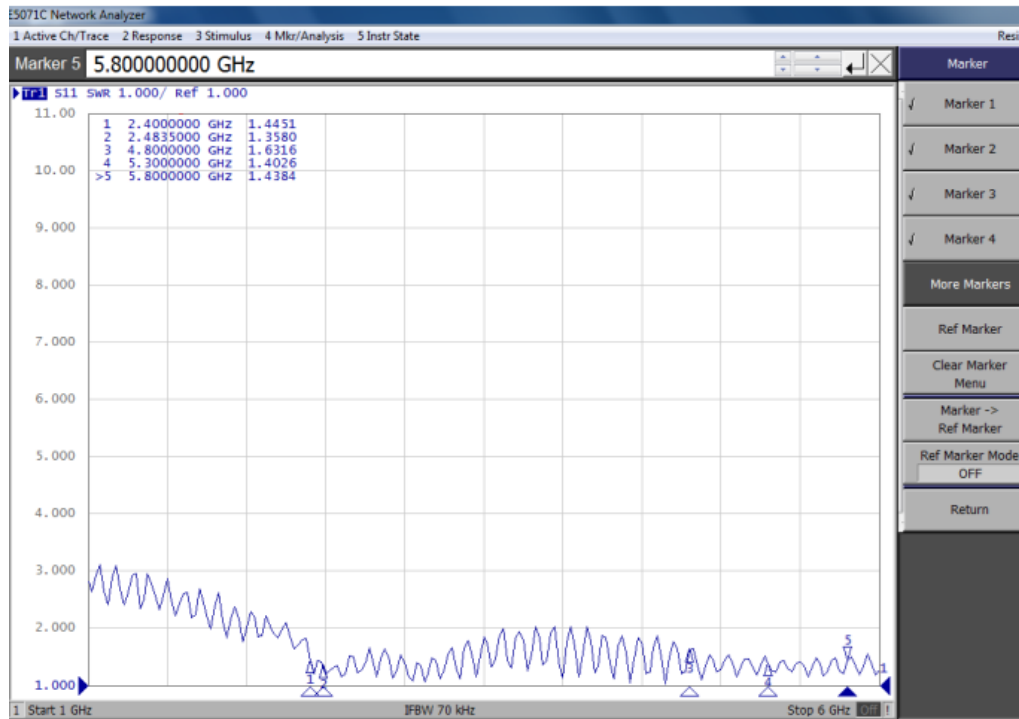

Gain and Efficiency

| Frequency (MHz) | Efficiency | Gain (dBi) |
|-----------------|------------|------------|
| 698.0 | 0.52 | 2.05 |
| 824.0 | 0.57 | 2.18 |
| 868.0 | 0.67 | 2.89 |
| 960.0 | 0.58 | 1.1 |
| 1710.0 | 0.57 | 0.8 |
| 1850.0 | 0.52 | 0.45 |
| 1990.0 | 0.57 | 0.81 |
| 2170.0 | 0.61 | 1.87 |
| 2690.0 | 0.56 | 1.69 |
| 2400.0 | 0.63 | 0.67 |
| 2450.0 | 0.62 | 1.75 |
| 2483.5 | 0.59 | 1.96 |
| 4800.0 | 0.57 | 0.83 |
| 5300.0 | 0.56 | 1.85 |
| 5800.0 | 0.58 | 1.75 |

External GPS/GLONASS + LTE MIMO + WiFi MIMO Antenna



AEACBK110053-MLWG



Ø110.0 x 53.0 mm
RoHS/RoHS II Compliant
MSL = 1

Radiation Patterns

2D Radiation Patterns
GPS Antenna

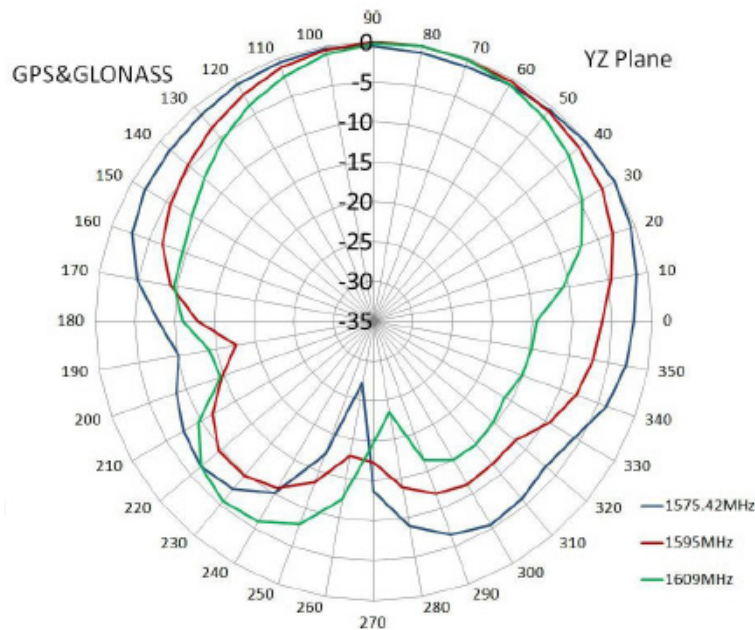
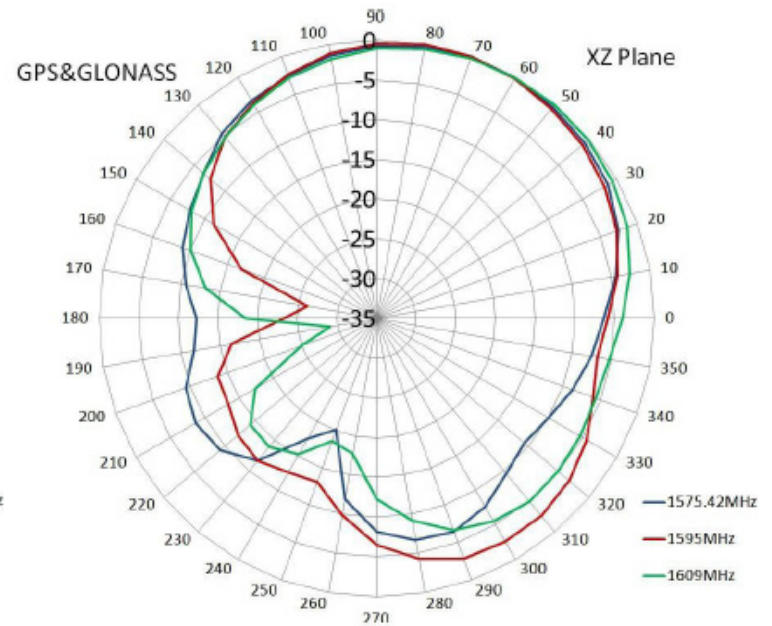
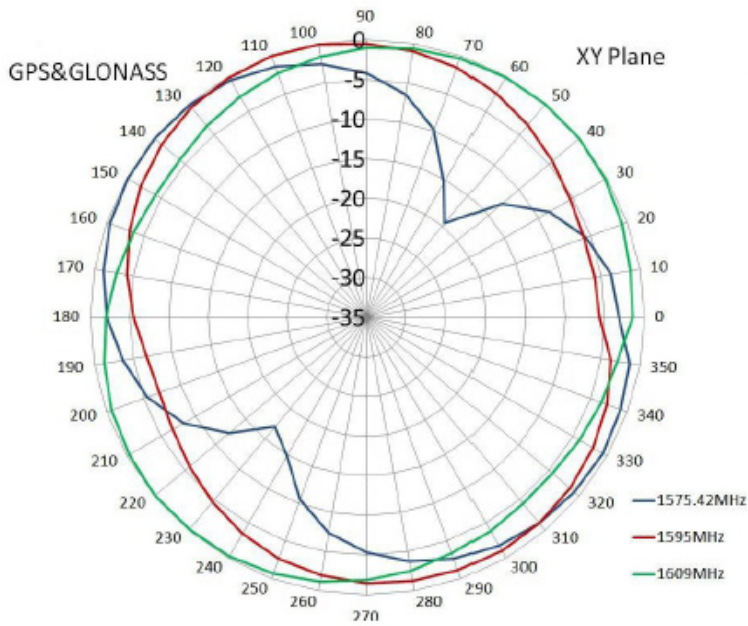

External GPS/GLONASS + LTE MIMO + WiFi MIMO Antenna



AEACBK110053-MLWG



Ø110.0 x 53.0 mm
RoHS/RoHS II Compliant
MSL = 1

LTE Antenna

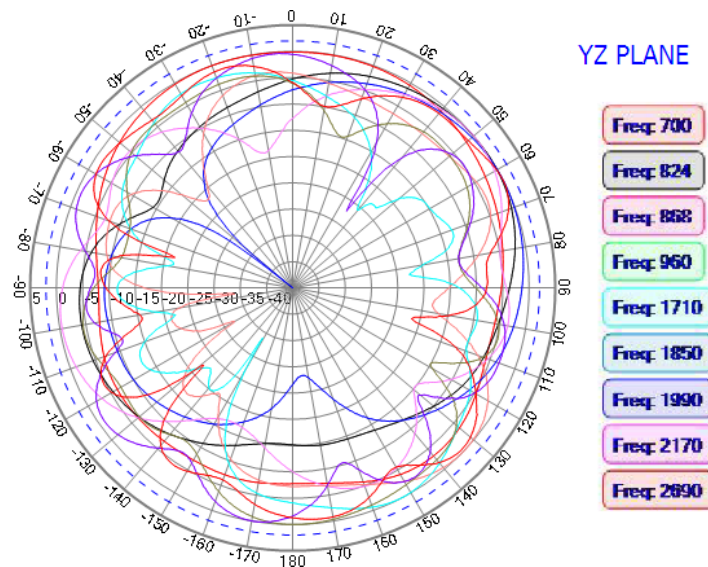
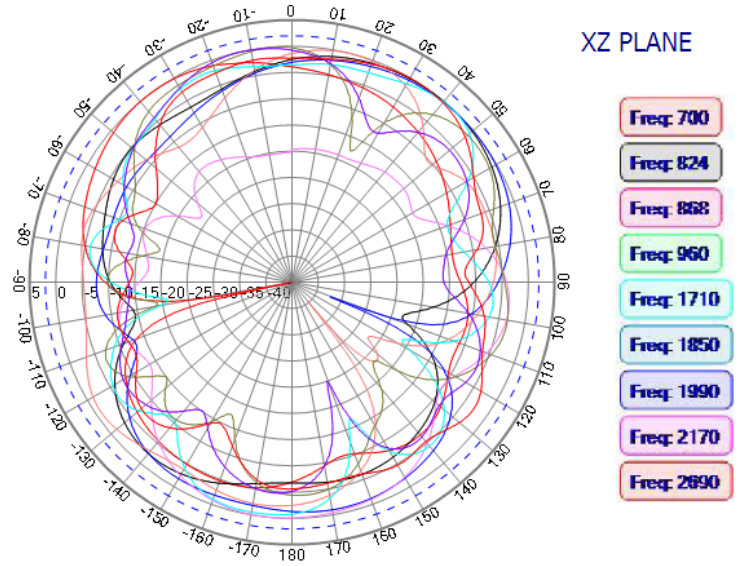
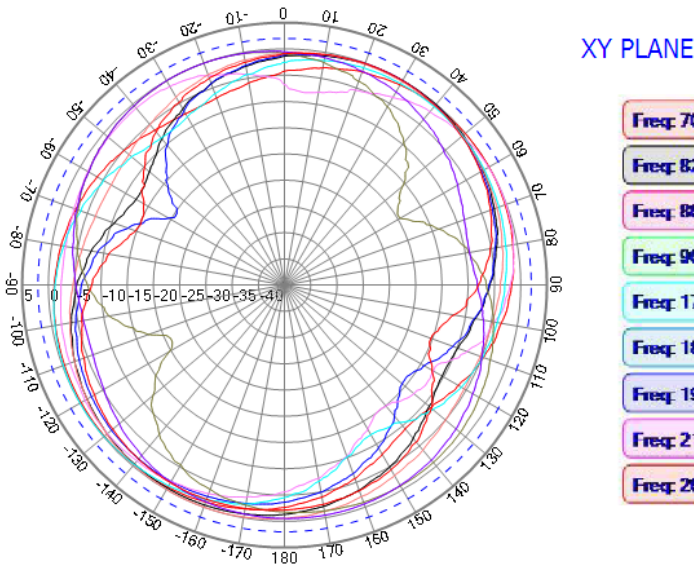

External GPS/GLONASS + LTE MIMO + WiFi MIMO Antenna



AEACBK110053-MLWG



Ø110.0 x 53.0 mm
RoHS/RoHS II Compliant
MSL = 1

WiFi Antenna

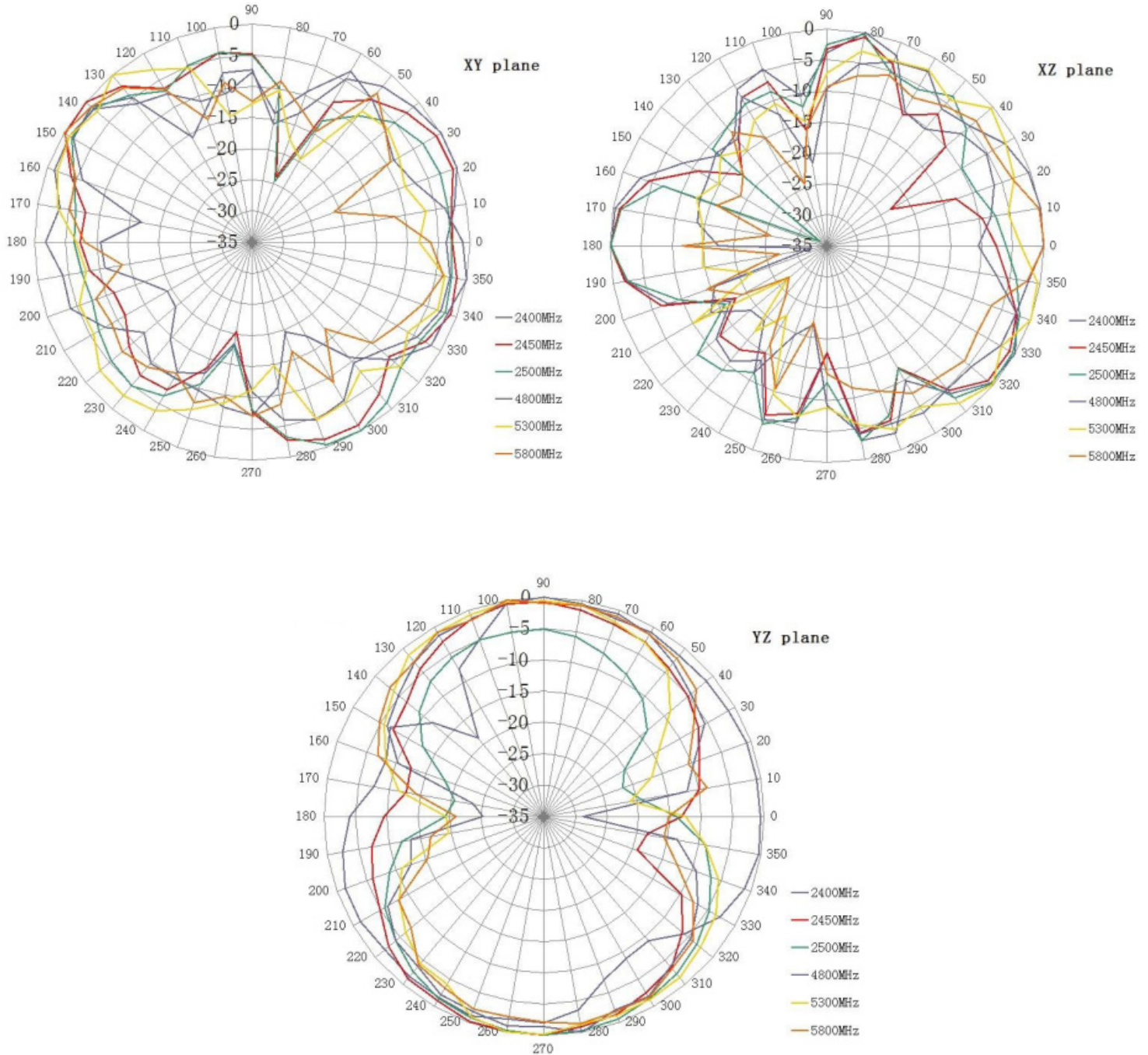

External GPS/GLONASS + LTE MIMO + WiFi MIMO Antenna



AEACBK110053-MLWG



Ø110.0 x 53.0 mm
RoHS/RoHS II Compliant
MSL = 1

3D Radiation Patterns

GPS/GLONASS Antenna

1575.42MHz

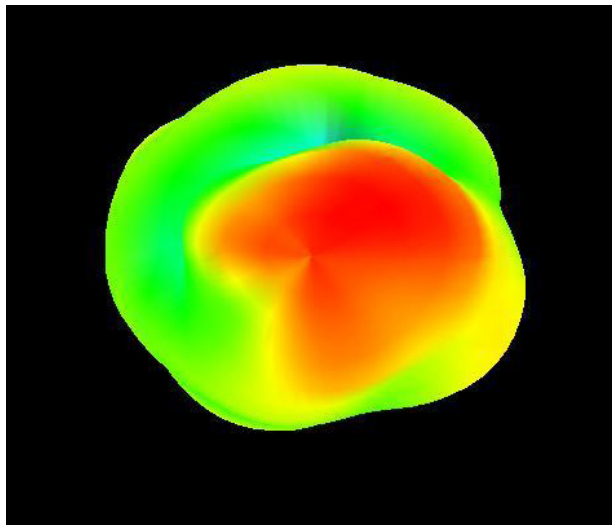

1610MHz

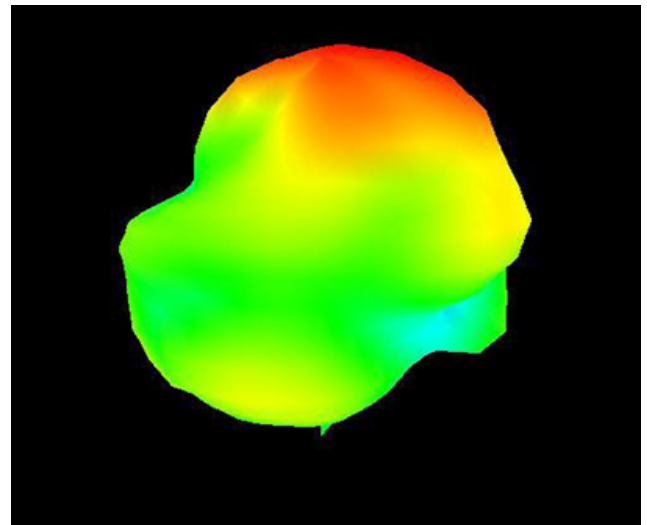

LTE Antenna

698 MHz

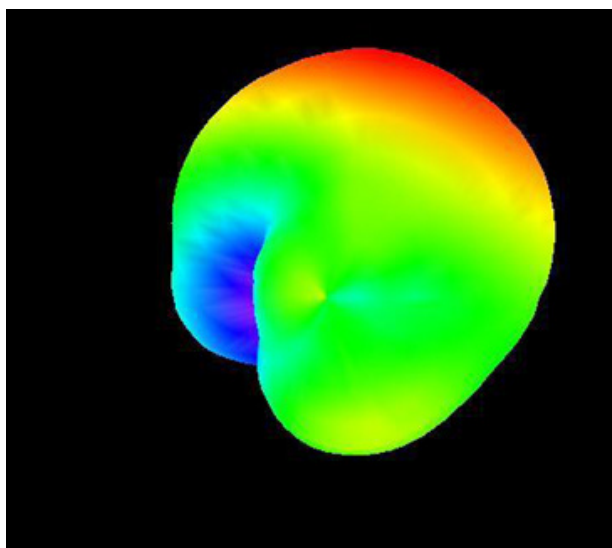

824 MHz

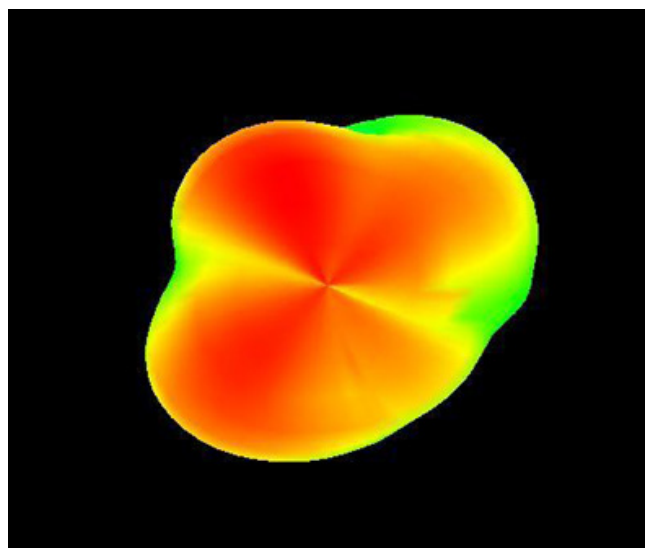

External GPS/GLONASS + LTE MIMO + WiFi MIMO Antenna



AEACBK110053-MLWG



Ø110.0 x 53.0 mm
RoHS/RoHS II Compliant
MSL = 1

3D Radiation Patterns

868 MHz

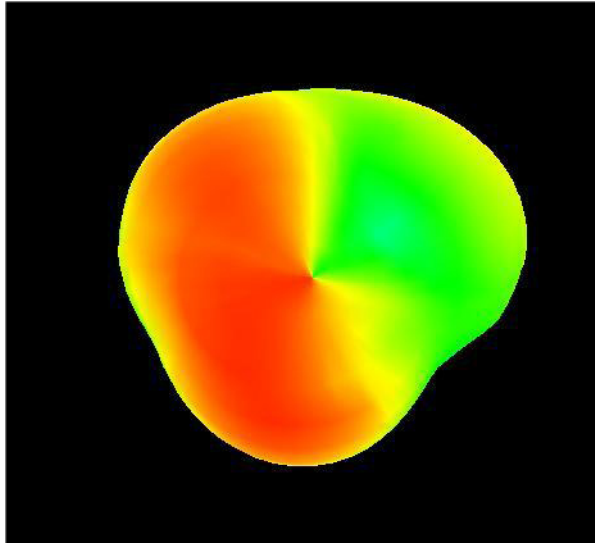

960 MHz

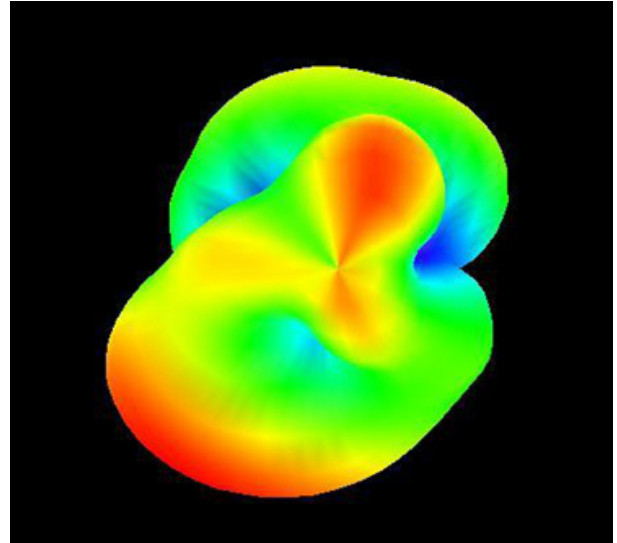

1710 MHz

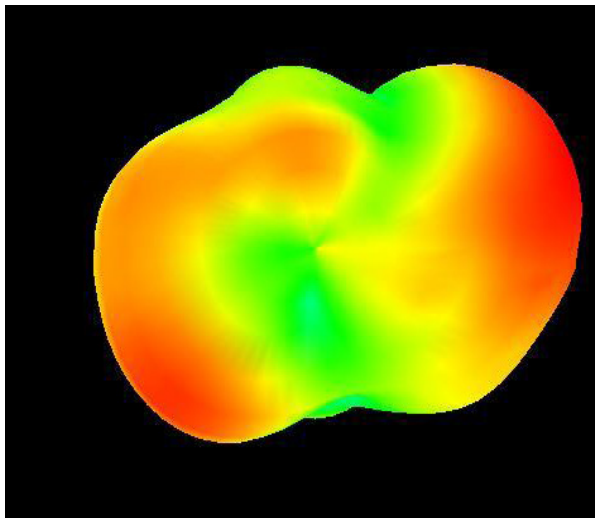

1850 MHz

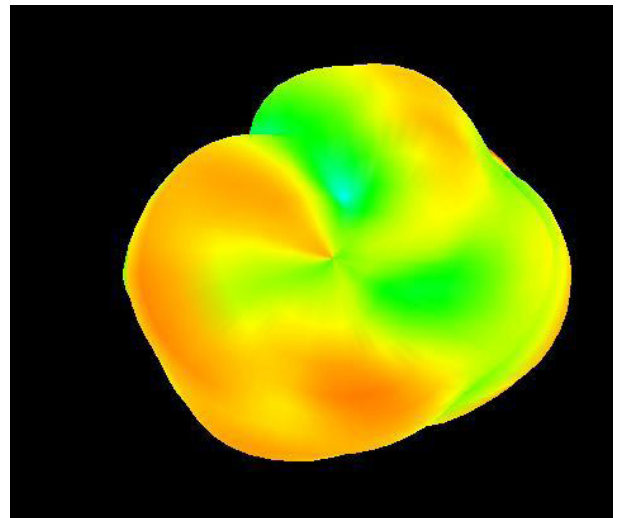

External GPS/GLONASS + LTE MIMO + WiFi MIMO Antenna



AEACBK110053-MLWG



Ø110.0 x 53.0 mm
RoHS/RoHS II Compliant
MSL = 1

3D Radiation Patterns

1990 MHz

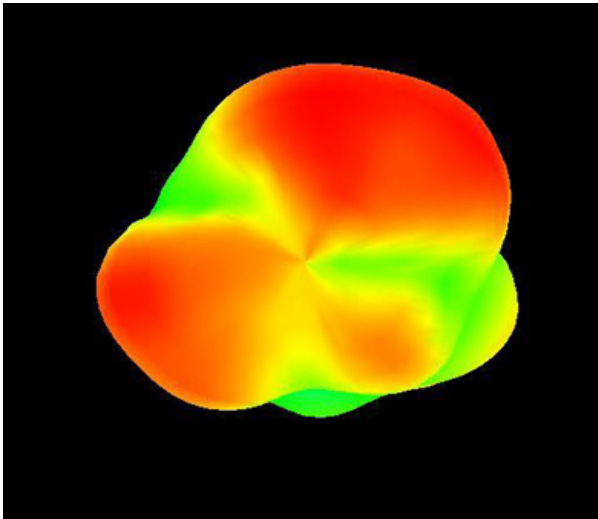

2170 MHz

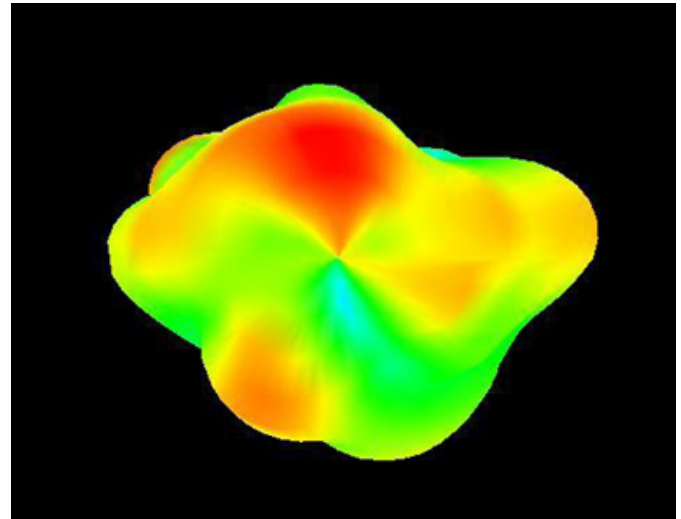

2690 MHz

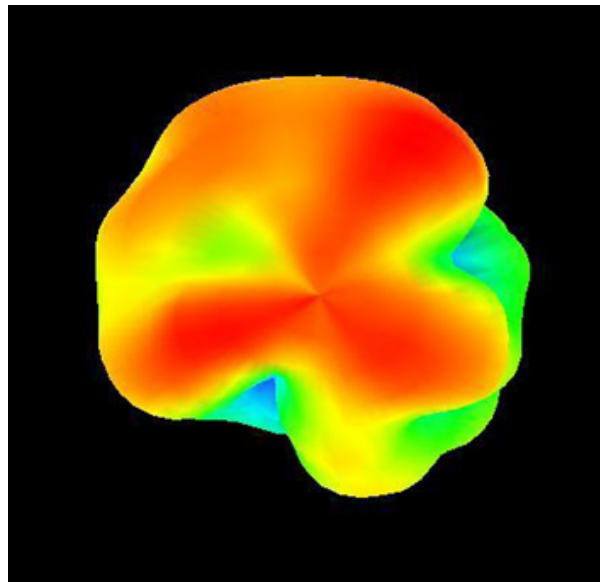

External GPS/GLONASS + LTE MIMO + WiFi MIMO Antenna



AEACBK110053-MLWG



Ø110.0 x 53.0 mm
RoHS/RoHS II Compliant
MSL = 1

3D Radiation Patterns

WiFi Antenna

2400MHz

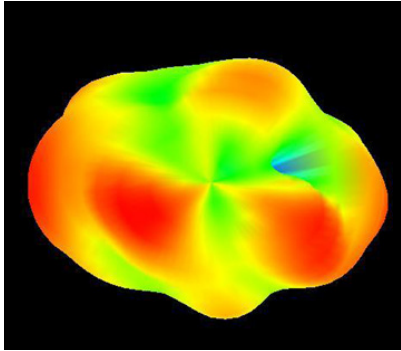

2483.5MHz

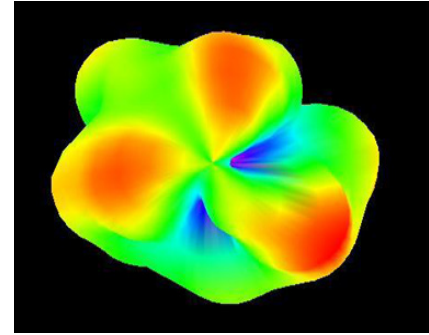

4800MHz

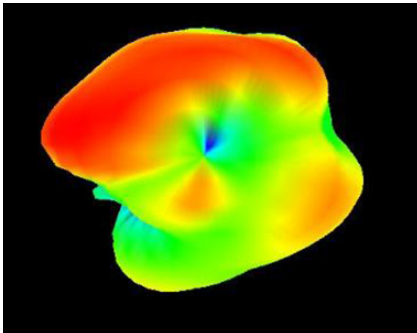

5300MHz

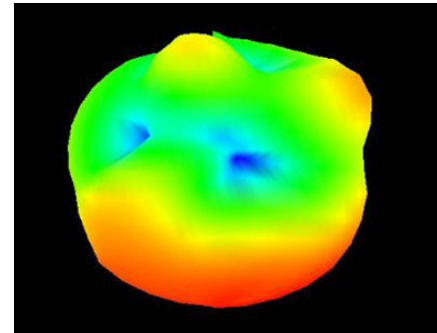

5800MHz

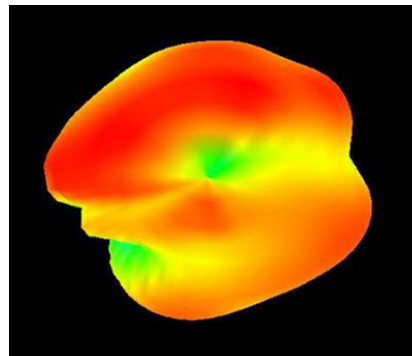

Packaging

Each 50.0 x 27.0 x 28.0 cm size carton includes 16 pcs antenna.

ATTENTION: Abracon LLC's products are COTS – Commercial-Off-The-Shelf products; suitable for Commercial, Industrial and, where designated, Automotive Applications. Abracon's products are not specifically designed for Military, Aviation, Aerospace, Life-dependent Medical applications or any application requiring high reliability where component failure could result in loss of life and/or property. For applications requiring high reliability and/or presenting an extreme operating environment, written consent and authorization from Abracon LLC is required. Please contact Abracon LLC for more information.



5101 Hidden Creek Ln Spicewood TX 78669
Phone: 512-371-6159 | Fax: 512-351-8858
For terms and conditions of sales, please visit:
www.abracon.com

REVISED: 11.27.2018

ABRACON IS
ISO9001-2015
CERTIFIED