



Science.
Applied to Life.™

The background of the entire page is a photograph of three surgeons in an operating room. They are wearing blue surgical gowns, blue bouffant caps, and white face masks. They are focused on a patient lying on a table, which is covered with blue and green drapes. A large surgical light is visible in the upper right, and a monitor is in the upper left. The scene is brightly lit, typical of an OR.

Surgical Drapes

Drape Selection Guide

SSIs create a human and financial cost

Occur in
2-5%
of all patients
undergoing
inpatient surgery¹

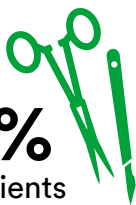

Cost on average
\$20,785
per patient²



Result in
2-11X
increased risk
of mortality¹



Increase
nursing care³



Lower
patient
satisfaction³



SSIs can affect a patient's quality of life and create stress for patients and their families. And they place a huge operational and financial burden on health care systems and providers. Using evidence-based practices to reduce skin microbes – before and during surgery – and creating a barrier to microbial migration can help reduce the risk of an SSI.

Fight SSIs from every angle.

3M™ Steri-Drape™ Absorbent Prevention Fabric

- Low-linting, nonwoven, absorbent fabric laminated to a plastic film
- Resistant to fluid strike-through
- Absorbent throughout the entire drape, eliminates the need to define a “critical zone”
- Meets Flammability Class 1 (CFR Title 16 Part 1610)

3M™ Ioban™ 2 Antimicrobial Incise Drape

- Designed with continuous broad-spectrum antimicrobial activity in the drape adhesive where it can't be washed away
- Clinically proven to help reduce the risk of wound contamination and immobilize bacteria on the skin^{4,5}

3M™ Ioban™ 2 Antimicrobial Incise Drape Easy-Delivery (EZ)

- Polyethylene liner is designed to come off smoothly, effortlessly, with no tearing, for easier drape delivery
- Drape and liner feature a full-width handle for control of liner release and drape application

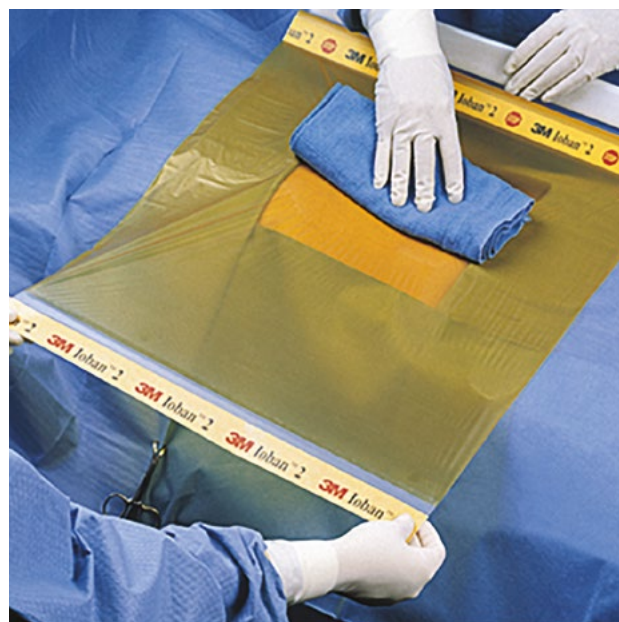

References

1. Anderson DJ, Podgorny K, Berrios-Torres SI, et al. Strategies to prevent surgical site infections in acute care hospitals: 2014 Update. *Infect Control Hosp Epidemiol.* 2014;35(6):605–27.
2. Zimlichman E, Henderson D, Tamir O, et al. Health care-associated infections: A meta-analysis of costs and financial impact on the U.S. health care system. *JAMA Intern Med.* 2013;173:2039–46.
3. Prevention and treatment of surgical site infection. NICE Web site. <https://www.nice.org.uk/guidance/cg74/evidence/full-guideline-242005933>. Published October 2008. Accessed January 30, 2017.
4. Dewan PA, Van Rij AM, Robinson RG, Skeggs GB, Fergus M. The use of an iodophor-impregnated plastic incise drape in abdominal surgery – a controlled clinical trial. *ANZ J Surg.* 1987;57:859–63.
5. French MLV, Eitzen HE, Ritter MA. The plastic surgical adhesive drape: an evaluation of its efficacy as a microbial barrier. *Ann Surg.* 1976;184:46–50.

DRAPE SELECTION GUIDE

	Page
Product Index by Catalog Number	iii-v
Six Principles of Draping	vi
3M™ Ioban™ 2 Antimicrobial Incise and Specialty Fabric Drapes	2-5
3M™ Steri-Drape™ 2 Incise Drapes	6-7
3M™ Steri-Drape™ Orthopaedic Drapes	8-15
3M™ Steri-Drape™ Cardiovascular/Cardiac Catheterization Drapes	16-19
3M™ Steri-Drape™ Obstetrics and Gynaecology Drapes	20-25
3M™ Steri-Drape™ EENT Drapes	26-29
3M™ Steri-Drape™ General Surgery Drapes	30-37
3M™ Steri-Drape™ Urology Drapes	38-41
3M™ Steri-Drape™ Neurology Drapes.....	42-45
3M™ Steri-Drape™ Surgical Sheets and Accessories.....	46-53
3M™ Steri-Drape™ Fluid Collection Pouches	54-55
3M™ Steri-Drape™ Equipment Drapes	56

INDEX BY CATALOG NUMBER

Drape	Description	Page	Drape	Description	Page
1000	Disp Roll Prep Drape	49	1033 1033NS	Medium Drape with Wide Adhesive Aperture	28
1000NSR	Roll Prep Drape	49	1035 1035NS	Incise Drape	7
1000 1000NSD 1000NS	Small Towel Drape	49	1040 1040NS	Incise Drape	7
1003 1003NS	Isolation Bag	36, 52	1050 1050NS	Incise Drape	7
1007	Arthroscopy Fluid Collection Pouch	15	1051 1051NS	Incise Drape	7
1010 91010SD 1010NS	Large Towel Drape	49	1055B 1055NS	Large Ophthalmic Sheet with Incise Film and Pouches	29
1012 1012NS	Fluoroscope Drape	56	1060 1060NS	Medium Drape with Incise Film	28
1013 1013NS	C-arm Drape	56	1061 1061NS	Medium Drape with Incise Film and Pouch	28
1014 1014NS	Patient Isolation Drape	10	1062 1062NS	Ophthalmic Incise Drape with Pouch	29
1015 1015NSD 1015NS	U-drape	14, 44, 46	1064 1064NS	Ophthalmic Sheet with Aperture and Pouches	29
1016 1016NS	Irrigation Pouch	15, 24, 37, 41, 45, 54	1065B 1065NS	Large Ophthalmic Sheet with Aperture and Pouches	29
1017	Isolation Drape with Incise Film and Pouch	11	1067 1067NS	U-pouch	15, 45, 55
1018 1018NS	Instrument Pouch	52	1071 1071NS	Urological Drape	41
1018L 1018LNS	Long Instrument Pouch	52	1072 1072NS	Aperture Pouch Drape	25, 37, 41, 54
1019 1019NS	Long U-drape	14, 45, 46	1073	Wound Edge Protector	36, 52
1020 1020NS	Small Drape with Adhesive Aperture	26, 47	1074	Wound Edge Protector	36, 52
1021 1021NS	Small Drape with Incise Sheet	26, 47	1075	Wound Edge Protector	36, 52
1022 1022NS	Refractive Drape	27	1076	Wound Edge Protector	36, 52
1023 1023NS	Small Drape with Incise Film and Pouch	27	1077	Wound Edge Protector	36, 52
1024 1024NS	Small Drape with Adhesive Aperture and Pouch	27, 54	1080 1080NS	Gynecology Drape	21, 40
1027 1027NS	Irrigation Pouch	54	1081 1081NS	TUR/Urological Drape	40
1030 1030NS	Medium Drape with Adhesive Aperture	28, 47	1083 1083NS	Perineal/Leg Sheet	18
1031 1031NS	Laparoscopic Drape/Supine Position	21, 32, 39	1084 1084NS	Under Buttocks Drape with Pouch	25, 37, 41, 54
1032 1032NS	Laparoscopic Drape/Lithotomy Position	21, 32, 39	1089 1089NS	Utility Sheet (2)	51
			1090 1090NS	Femoral Angiography Drape	17

Drape	Description	Page
1092 1092NS	Small Drape with Adhesive Aperture	48
1094 1094NS	Arthroscopy Sheet with Pouch	13
1095	Arthroscopy Pack	8
1115	Tube Organizer	53
1135	PICC Drape with Adhesive Aperture	47
1191	Femoral Angiography Drape	17
1192	Venous/Arterial Access Drape	17
1194 1194NS	Arthroscopy Sheet with Pouch	13
1195	Arthroscopy Pack	8
2035 2035NS	Incise Drape	6
2037 2037NS	Incise Drape	6
2040 2040NS	Incise Drape	6
2045 2045NS	Incise Drape	6
2050 2050NS	Incise Drape	6
2051 2051NS	Incise Drape	6
2057 2057NS	Incise Pouch	24, 35, 55
2058 2058NS	Aperture Pouch Drape	24, 35, 55
2065 2065NS	Abdominoperineal Incise Drape	21, 32, 39
6617	Isolation Drape with loban 2 Incise Film and Pouch	2, 11
6619	Large Isolation Drape with loban 2 Incise Film and Pouch	2, 11
6635	loban 2 Antimicrobial Incise Drape	2
6640	loban 2 Antimicrobial Incise Drape	2
6640EZ 6640EZSB	loban 2 Antimicrobial Incise Drape	2
6648	loban 2 Antimicrobial Incise Drape	2
6648EZ 6648EZSB	loban 2 Antimicrobial Incise Drape	2
6650	loban 2 Antimicrobial Incise Drape	3
6650EZ 6650EZSB	loban 2 Antimicrobial Incise Drape	3

Drape	Description	Page
6651	loban 2 Antimicrobial Incise Drape	3
6651EZ 6651EZSB	loban 2 Antimicrobial Incise Drape	3
6657	Pouch with loban 2 Incise Film	3, 24, 35, 55
6658	Pouch with loban 2 Incise Film, Large	3, 35, 55
6659	Pouch with loban 2 Incise Film, Extra Large	35, 55
6661EZ 6661EZSB	loban 2 Antimicrobial Incise Drape	3
6665	Abdominal-Perineal Drape with loban 2 Incise Film - Lithotomy Position	4, 22, 32, 39
6677	Cardiovascular Sheet with loban 2 Incise Film	4, 18
6678	Cardiovascular Pack	4, 18
6681	Cardiovascular Drape with loban 2 Incise Film	5, 19
6682	Cardio/Chest Drape with loban 2 Incise Film	5
6687	Craniotomy Drape with loban 2 Incise Pouch	5, 44
6697	Cesarean Section Sheet with loban 2 Incise Pouch	5, 23
6697CA	Cesarean-Section Drape with loban 2 Incise Pouch, Clear Anesthesia Screen	23
7965 7965NS	Cesarean Section Drape with Incise Sheet with Pouch	23
7966 7966NS	Cesarean Section Sheet with Aperture Pouch	23
9000A	Basic Surgical Pack	8, 16, 20, 30, 38, 42
9000LA	Basic Surgical Pack	8, 16, 20, 30, 38, 42
9002	Orthopaedic Pack without Mayo Stand Cover	9
9003	Cystoscopy Pack	20, 30, 38
9007A	ENT Pack	26
9008A	Head and Neck Pack	26
9010	Basic Surgical Pack without Mayo Stand Cover	9, 16, 20, 31, 38, 42
9012A	Orthopaedic Pack without Mayo Stand Cover	9
9012LA	Orthopaedic Pack	10
9014A	Extremity Pack	10
9018A	Surgical Split Sheet Pack	31, 43
9020A	Basic Set Up Pack	20, 26, 31, 38
9021A	Orthopaedic Set Up Pack	10

INDEX BY CATALOG NUMBER

Drape	Description	Page
9022A	Cardiovascular Set Up Pack	17
9026 9026NS	Aperture Drape	48
9029 9029NS	Adhesive Aperture Drape	48
9030	Adhesive Aperture Drape	48
9030NS	Adhesive Aperture Drape	48
9031	Adhesive Aperture Drape	48
9031NS	Adhesive Aperture Drape	48
9036 9036NS	Mayo Stand Cover	52
9040 9040NS	Leggings (2)	25, 41, 53
9041NS	Extremity Cover	15, 53
9042NS	Extremity Cover	15, 53
9043	Adhesive Split Sheet	14, 44, 46
9043	Extremity Cover	15, 53
9043NS	Adhesive Split Sheet	14, 44, 46
9044	Adhesive Split Sheet	14, 15, 44, 46
9044NS	Adhesive Split Sheet	14, 44, 46
9044	Extremity Cover	15, 53
9045	Adhesive Split Sheet	14, 44, 46
9045NS	Adhesive Split Sheet	14, 44, 46
9046 9046NS	Bilateral Adhesive Split Sheet	14, 19
9047 9047NS	Neuro Split Sheet with Pouch	43
9048 9048NS	Adhesive Split Sheet	43, 47
9050 9050NS	Adhesive Aperture Drape	33, 48
9051 9051NS	Thyroid Drape	34
9052 9052NS	Hand Drape	11, 34
9053 9053NS	Extremity Drape	12
9054 9054NS	Hand and Foot Drape	12, 34
9055 9055NS	Hip Drape with Pouches	13

Drape	Description	Page
9056 9056NS	Bilateral Foot Drape	12, 34
9062 9062NS	Laparotomy Drape (Transverse)	22, 33, 40
9063 9063NS	Laparotomy Drape	22, 33, 40
9069 9069NS	Drape Sheet	51
9072 9072NS	Back Table Cover	51
9077 9077NS	Back Table Cover	51
9079 9079NS	Back Table Cover	51
9084 9084NS	Adhesive Towel Drape	49
9085 9085NS	Adhesive Towel Drape	49
9086 9086NS	Adhesive Towel Drape	50
9087 9087NS	Adhesive Drape Sheets	50
9088 9088NS	Adhesive Drape Sheets	50
9090 9090NS	Adhesive Drape Sheets	50
9095	Absorbent Pad	53
9097 9097NS	Instrument Pouch (L)	52
9099 9099NS	Operation Tape	53
9196, 9196NS	Shoulder Split Sheet with Pouch	13

3M™ SURGICAL DRAPES

A line of drapes designed with the six principles of draping in mind

Whether a surgery is performed in a traditional operating room, an ambulatory surgery center or a physician's office, you can be sure of one thing: one or more surgical drapes will be used. And every drape used during that procedure will address one or more of the six basic draping objectives or "principles." 3M offers many single-use, disposable surgical drapes to help meet these principles:



1. Isolation

Isolating dirty, contaminated areas from clean areas.



2. Barrier

Preventing fluid penetration.



3. Sterile Field

Creating a sterile operative environment by aseptic application of sterile materials.

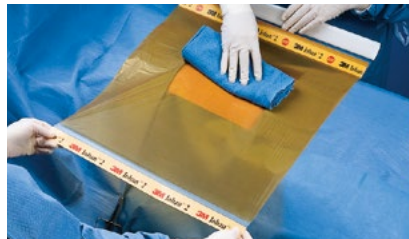

4. Sterile Surface

Creating a sterile surface on the skin which acts as a barrier to help prevent skin flora from migrating to the incision site.

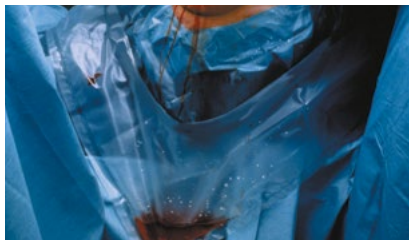

5. Fluid Control

Channeling and collecting body and irrigation fluids.



6. Equipment Draping

Allowing non-sterile equipment to be brought into the sterile field.

ANTIMICROBIAL INCISE AND SPECIALTY FABRIC DRAPES

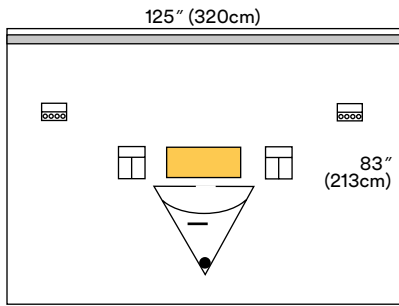

6617 Isolation Drape with Ioban™ 2 Incise Film and Pouch

Overall Size	Drapes/Box	Boxes/Case
125" x 83" (320cm x 213cm)	5	4

- Ioban 2 antimicrobial incise area: 19" x 9.37" (50cm x 24cm)
- Fluid collection pouch with screen
- 1 – Exit port
- 2 – Instrument pouches
- 2 – Tube and cord organizers
- Adhesive strip along top

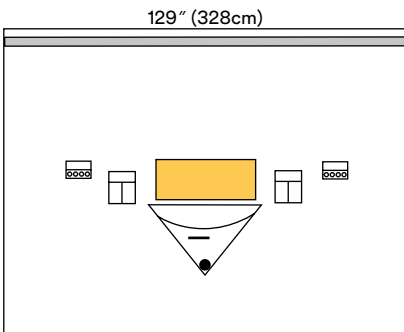

6619 Large Isolation Drape with Ioban 2 Incise Film and Pouch

Overall Size	Drapes/Box	Box/Case
129" x 100" (328cm x 254cm)	5	1

- Ioban 2 antimicrobial incise area: 27" x 12" (70cm x 32cm)
- Fluid collection pouch with screen
- 1 – Exit port
- 2 – Instrument pouches
- 2 – Tube and cord organizers

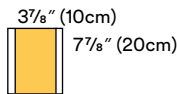

6635 Ioban 2 Antimicrobial Incise Drape

Incise Area	Drapes/Box	Boxes/Case
3 7/8" x 7 7/8" (10cm x 20cm)	10	4

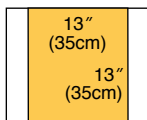

6640EZ* Ioban 2 Antimicrobial Incise Drape

Incise Area	Drapes/Box	Boxes/Case
13" x 13" (35cm x 35cm)	10	4

6640EZSB (Sterile Bulk) *Custom Packs Only*

10 ea/cs

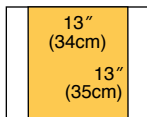

6640** Ioban 2 Antimicrobial Incise Drape

Incise Area	Drapes/Box	Boxes/Case
13" x 13" (34cm x 35cm)	10	4

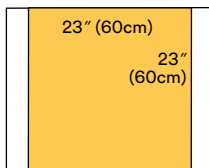

6648EZ* Ioban 2 Antimicrobial Incise Drape

Incise Area	Drapes/Box	Boxes/Case
23" x 23" (60cm x 60cm)	10	4

6648EZSB (Sterile Bulk) *Custom Packs Only*

75 ea/cs

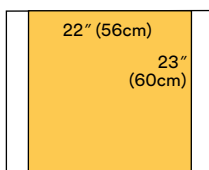

6648** Ioban 2 Antimicrobial Incise Drape

Incise Area	Drapes/Box	Boxes/Case
22" x 23" (56cm x 60cm)	10	4

KEY

 Absorbent Prevention Fabric

 Standard Blue Fabric (fluid-repellent)

 Clear plastic film

 3M™ Ioban™ 2 Antimicrobial Incise Film

 3M™ Steri-Drape™ 2 Incise Film

 Adhesive area

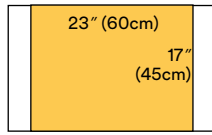

6650EZ* Ioban 2 Antimicrobial Incise Drape

Incise Area	Drapes/Box	Boxes/Case
23" x 17" (60cm x 45cm)	10	4

6650EZSB (Sterile Bulk) <i>Custom Packs Only</i>	10 ea/cs	
---	----------	--

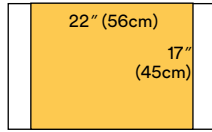

6650** Ioban 2 Antimicrobial Incise Drape

Incise Area	Drapes/Box	Boxes/Case
22" x 17" (56cm x 45cm)	10	4

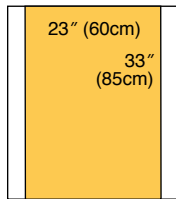

6651EZ* Ioban 2 Antimicrobial Incise Drape

Incise Area	Drapes/Box	Boxes/Case
23" x 33" (60cm x 85cm)	10	4

6651EZSB (Sterile Bulk) <i>Custom Packs Only</i>	50 ea/cs	
---	----------	--

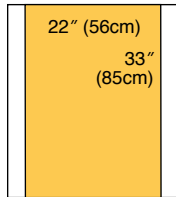

6651** Ioban 2 Antimicrobial Incise Drape

Incise Area	Drapes/Box	Boxes/Case
22" x 33" (56cm x 85cm)	10	4

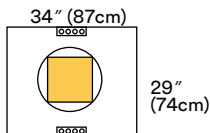

6657 Pouch with Ioban 2 Incise Film

Overall Size	Drapes/Box	Boxes/Case
34" x 29" (87cm x 74cm)	10	4

- Ioban 2 antimicrobial incise area: 11" x 11" (30cm x 30cm)
- 360-degree fluid collection pouch
- Tube and cord organizers

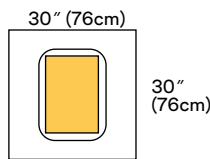

6658 Pouch with Ioban 2 Incise Film, Large

Overall Size	Drapes/Box	Boxes/Case
30" x 30" (76cm x 76cm)	5	4

- Ioban 2 antimicrobial incise area: 13" x 17" (33cm x 43cm)
- 360-degree fluid collection pouch

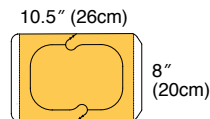

6661EZ* Ioban 2 Antimicrobial Incise Drape

Incise Area	Drapes/Box	Boxes/Case
10.5" x 8" (26cm x 20cm)	50	4

6661EZSB (Sterile Bulk) <i>Custom Packs Only</i>	400 ea/cs	
---	-----------	--

*Denotes Ioban 2 drapes with easy-delivery features. Available in the U.S. and limited markets outside the U.S.

**Available outside the U.S. only

Easy-delivery (products denoted with EZ) features include:

- Polyethylene liner comes off smoothly, effortlessly, with no tearing, for easier drape delivery
- Drape and liner feature a full-width handle for control of liner release and drape application
- Strip at one end imprinted with stop signs indicates when the end of the drape is near



ANTIMICROBIAL INCISE AND SPECIALTY FABRIC DRAPES

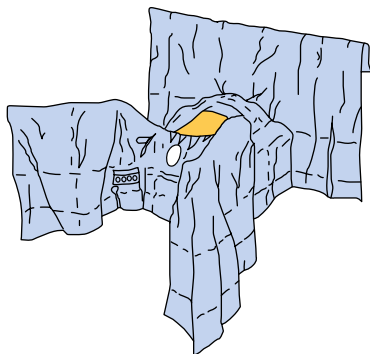

6665 Abdominal-Perineal Drape with Ioban 2 Incise Film – Lithotomy Position

Overall Size	Drapes/Box	Boxes/Case
78" x 107" (200cm x 274cm)	5	1

- Ioban 2 antimicrobial incise area: 13" x 17" (33cm x 45cm)
- Peri/vag. aperture: 4⁵/₈" x 6" (12cm x 15.5cm)
- Tube and cord organizers (ref.1115)

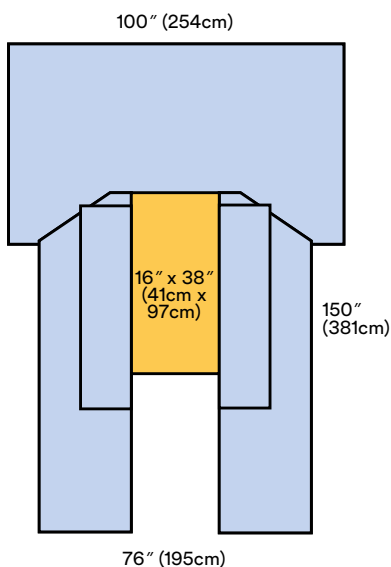

6677 Cardiovascular Sheet with Ioban 2 Incise Film

Overall Size	Drapes/Box	Boxes/Case
100" x 150" (254cm x 381cm)	6	1

- Ioban 2 antimicrobial incise area: 16" x 38" (41cm x 97cm)
- Dual side pockets
- Reinforced anesthesia screen

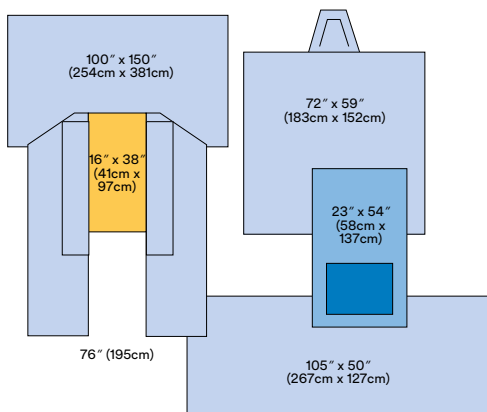

6678 Cardiovascular Pack

Name	Quantity	Overall Size	Packs/Box	Boxes/Case
6678 Cardiovascular Pack				
6677 Steri-Drape Cardiovascular Sheet with Ioban 2 Incise Film	1	100" x 150" (254cm x 381cm)	4	1
1083 Perineal/Leg Sheet	1	72" x 59" (183cm x 152cm)		
9036 Mayo Stand Cover	1	23" x 54" (58cm x 137cm)		
Back Table Cover	1	105" x 50" (267cm x 127cm)		

KEY

Absorbent Prevention Fabric	Standard Blue Fabric (fluid-repellent)	Clear plastic film	3M™ Ioban™ 2 Antimicrobial Incise Film	3M™ Steri-Drape™ 2 Incise Film	Adhesive area

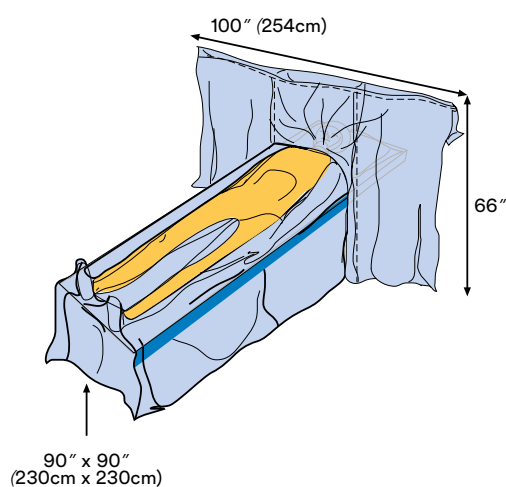

6681 Cardiovascular Drape with loban 2 Incise Film

Overall Size	Drapes/Box	Box/Case
100" x 151" (254cm x 384cm)	8	1

- loban 2 antimicrobial incise area: 16" x 61" (41cm x 154cm)
- One-piece design
- Expansion pleat between legs
- Blue anesthesia screen
- loban 2 antimicrobial incise film in both chest and leg areas

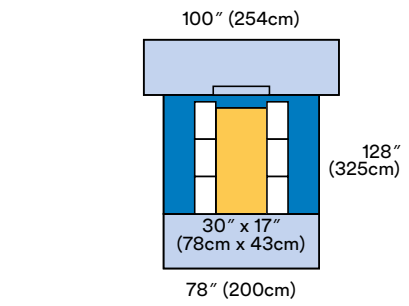

6682 Cardio/Chest Drape with loban 2 Incise Film

Overall Size	Drapes/Box	Boxes/Case
78" x 128" (200cm x 325cm)	8	1

- loban 2 antimicrobial incise area: 30" x 17" (78cm x 43cm)
- One-piece design
- Extended width for arm coverage
- Reinforced anesthesia screen with cord organizer
- Divided bilateral side pockets for instruments

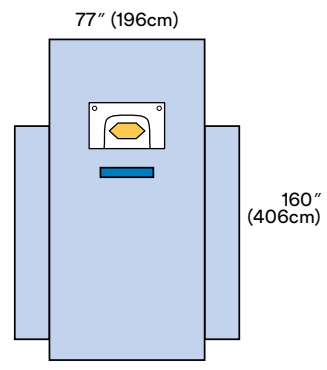

6687 Craniotomy Drape with loban 2 Incise Pouch

Overall Size	Drapes/Box	Boxes/Case
77" x 160" (196cm x 406cm)	10	1

- Incise area: 15" x 8" (36.8cm x 21.4cm)
- Large rectangular fluid collection pouch
- Reinforced plastic strip with a wide adhesive secural

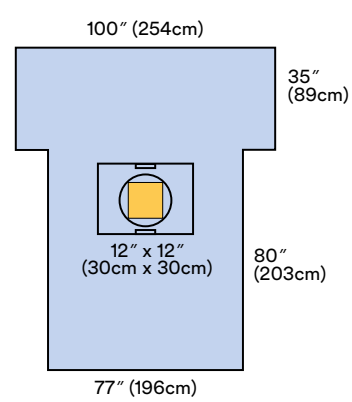

6697 Cesarean Section Sheet with loban 2 Incise Pouch

Overall Size	Drapes/Box	Box/Case
100" x 115" (254cm x 292cm)	5	1

- loban 2 antimicrobial incise area: 12" x 12" (30cm x 30cm)
- 360-degree fluid collection pouch
- Tube and cord organizers

Absorbent Prevention Fabric	Standard Blue Fabric (fluid-repellent)	Clear plastic film	3M™ loban™ 2 Antimicrobial Incise Film	3M™ Steri-Drape™ 2 Incise Film	Adhesive area



3M™ Steri-Drape™ 2 INCISE DRAPES

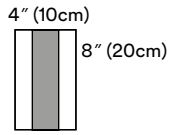

2035 Incise Drape

Incise Area	Drapes/Box	Boxes/Case
4" x 8" (10cm x 20cm)	10	4
2035NS (non-sterile) <i>Custom Packs Only</i>	200 ea/cs	

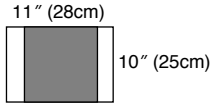

2037 Incise Drape

Incise Area	Drapes/Box	Boxes/Case
11" x 10" (28cm x 25cm)	10	4
2037NS (non-sterile) <i>Custom Packs Only</i>	200 ea/cs	

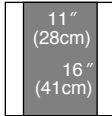

2040 Incise Drape

Incise Area	Drapes/Box	Boxes/Case
11" x 16" (28cm x 41cm)	10	4
2040NS (non-sterile) <i>Custom Packs Only</i>	200 ea/cs	



2045 Incise Drape

Incise Area	Drapes/Box	Boxes/Case
19" x 17" (50cm x 45cm)	10	4
2045NS (non-sterile) <i>Custom Packs Only</i>	200 ea/cs	

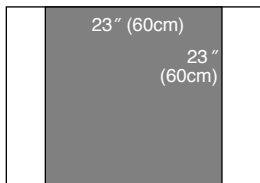

2050 Incise Drape

Incise Area	Drapes/Box	Boxes/Case
23" x 23" (60cm x 60cm)	10	4
2050NS (non-sterile) <i>Custom Packs Only</i>	200 ea/cs	

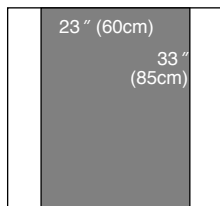

2051 Incise Drape

Incise Area	Drape/Box	Boxes/Case
23" x 33" (60cm x 85cm)	10	4
2051NS (non-sterile) <i>Custom Packs Only</i>	150 ea/cs	

KEY

 Absorbent Prevention Fabric

 Standard Blue Fabric (fluid-repellent)

 Clear plastic film

 3M™ Ioban™ 2 Antimicrobial Incise Film

 3M™ Steri-Drape™ 2 Incise Film

 Adhesive area

3M™ Steri-Drape™ 2 INCISE DRAPES

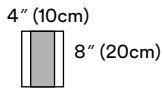

1035 Incise Drape

Incise Area	Drapes/Box	Boxes/Case
4" x 8" (10cm x 20cm)	10	4
1035NS (non-sterile) <i>Custom Packs Only</i>	200 ea/cs	

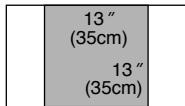

1040 Incise Drape

Incise Area	Drapes/Box	Boxes/Case
13" x 13" (35cm x 35cm)	10	4
1040NS (non-sterile) <i>Custom Packs Only</i>	200 ea/cs	

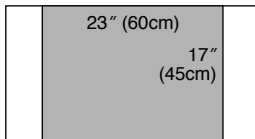

1050 Incise Drape

Incise Area	Drapes/Box	Boxes/Case
23" x 17" (60cm x 45cm)	10	4
1050NS (non-sterile) <i>Custom Packs Only</i>	200 ea/cs	

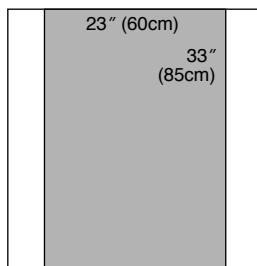

1051 Incise Drape

Incise Area	Drapes/Box	Boxes/Case
23" x 33" (60cm x 85cm)	10	4
1051NS (non-sterile) <i>Custom Packs Only</i>	150 ea/cs	

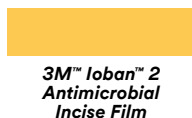

3M™ Steri-Drape™ ORTHOPAEDIC DRAPES

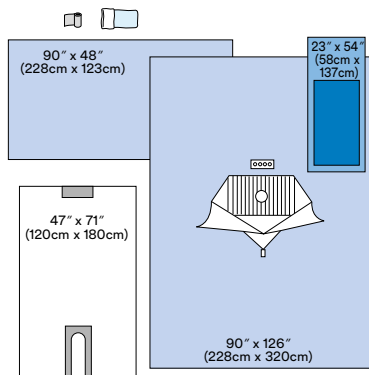

1095 Arthroscopy Pack

Name	Quantity	Overall Size	Packs/Box	Boxes/Case
1095 Arthroscopy Pack				
1094 Arthroscopy Sheet with Pouch	1	90" x 126" (228cm x 320cm)	5	1
1019 Long U-drape	1	47" x 71" (120cm x 180cm)		
Stockinette	1	9" x 30" (22cm x 76cm)		
3M™ Coban™ Self-Adherent Wrap	1	4"		
9036 Mayo Stand Cover	1	23" x 54" (58cm x 137cm)		
Back Table Cover	1	90" x 48" (228cm x 123cm)		
1095NS (non-sterile) <i>Custom Packs Only</i>			10 ea/cs	

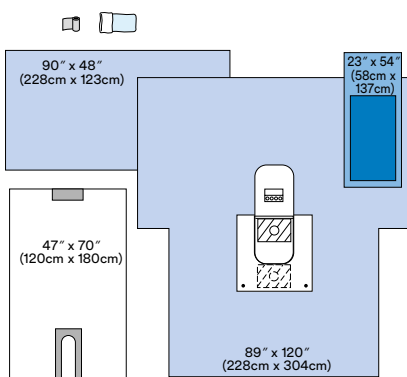

1195 Arthroscopy Pack

Name	Quantity	Overall Size	Packs/Box	Boxes/Case
1195 Arthroscopy Pack				
1194 Arthroscopy Sheet with Pouch	1	115" x 120" (292cm x 304cm)	5	1
1019 Long U-drape	1	47" x 71" (120cm x 180cm)		
Stockinette	1			
3M™ Coban™ Self-Adherent Wrap	1	4"		
9036 Mayo Stand Cover	1	23" x 54" (58cm x 137cm)		
Back Table Cover	1	90" x 48" (228cm x 123cm)		
1195NS (<i>Custom Packs Only</i>)			10 ea/cs	

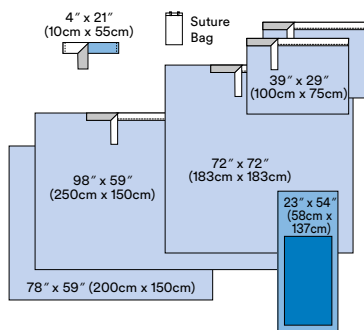

9000A Basic Surgical Pack

Name	Quantity	Overall Size	Packs/Box	Boxes/Case
9000A Basic Surgical Pack				
Suture Bag	1		7	2
9099 Operation Tape	1	4" x 21" (10cm x 55cm)		
9036 Mayo Stand Cover	1	23" x 54" (58cm x 137cm)		
9086 Adhesive Towel Drapes	2	39" x 30" (100cm x 76cm)		
9087 Adhesive Drape Sheet (M)	1	72" x 72" (183cm x 183cm)		
9088 Adhesive Drape Sheet (L)	1	98" x 59" (250cm x 150cm)		
9077 Back Table Cover	1	78" x 59" (200cm x 150cm)		

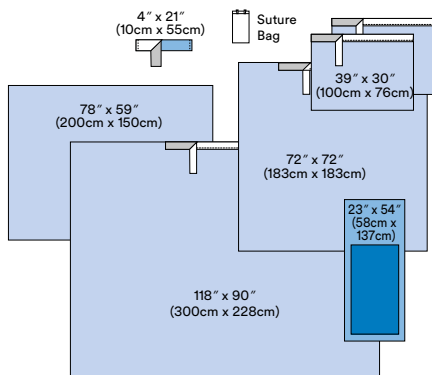

9000LA Basic Surgical Pack

Name	Quantity	Overall Size	Packs/Box	Boxes/Case
9000LA Basic Surgical Pack				
Suture Bag	1		5	2
9099 Operation Tape	1	4" x 21" (10cm x 55cm)		
9036 Mayo Stand Cover	1	23" x 54" (58cm x 137cm)		
9086 Adhesive Towel Drapes	2	39" x 30" (100cm x 76cm)		
9087 Adhesive Drape Sheet (M)	1	72" x 72" (183cm x 183cm)		
9090 Adhesive Drape Sheet (XL)	1	118" x 90" (300cm x 228cm)		
Back Table Cover	1	78" x 59" (200cm x 150cm)		

KEY

Absorbent Prevention Fabric	Standard Blue Fabric (fluid-repellent)	Clear plastic film	3M™ Ioban™ 2 Antimicrobial Incise Film	3M™ Steri-Drape™ 2 Incise Film	Adhesive area

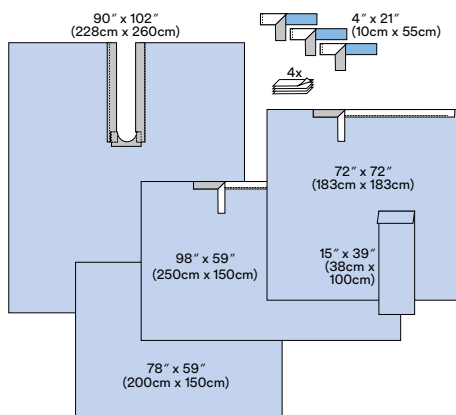

9002 Orthopaedic Pack without Mayo Stand Cover

Name	Quantity	Overall Size	Packs/Box	Boxes/Case
9002 Orthopaedic Pack without Mayo Stand Cover			5	2
9099 Operation Tapes	3	4" x 21" (10cm x 55cm)		
Hand Towels	4	-		
9042 Extremity Cover	1	15" x 39" (38cm x 100cm)		
9087 Adhesive Drape Sheet (M)	1	72" x 72" (183cm x 183cm)		
9045 Adhesive Split Sheet	1	90" x 102" (228cm x 260cm)		
9088 Adhesive Drape Sheet (L)	1	98" x 59" (250cm x 150cm)		
9077 Back Table Cover	1	78" x 59" (200cm x 150cm)		

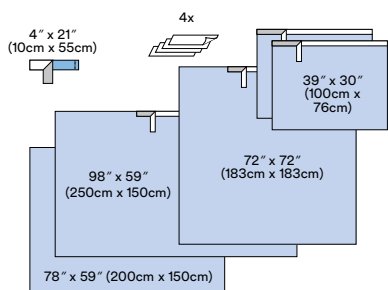

9010 Basic Surgical Pack without Mayo Stand Cover

Name	Quantity	Overall Size	Packs/Box	Boxes/Case
9010 Basic Surgical Pack without Mayo Stand Cover			7	2
9099 Operation Tape	1	4" x 21" (10cm x 55cm)		
Hand Towels	4	-		
9085 Adhesive Towel Drapes	2	39" x 33" (100cm x 85cm)		
9087 Adhesive Drape Sheet (M)	1	72" x 72" (183cm x 183cm)		
9088 Adhesive Drape Sheet (L)	1	98" x 59" (250cm x 150cm)		
9077 Back Table Cover	1	78" x 59" (200cm x 150cm)		

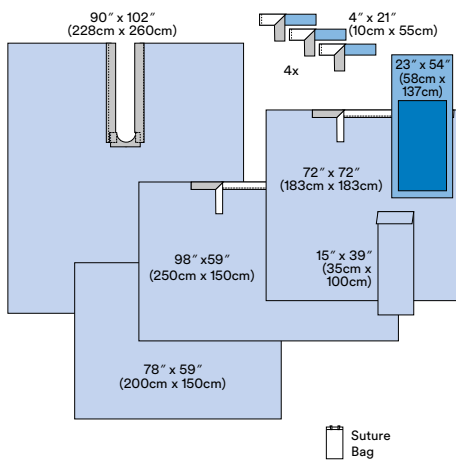

9012A Orthopaedic Pack

Name	Quantity	Overall Size	Packs/Box	Boxes/Case
9012A Orthopaedic Pack			5	2
Suture Bag	1			
9099 Operation Tape	1	4" x 21" (10cm x 55cm)		
9036 Mayo Stand Cover	1	23" x 54" (58cm x 137cm)		
9042 Extremity Cover	1	15" x 39" (38cm x 100cm)		
9087 Adhesive Drape Sheet (M)	1	72" x 72" (183cm x 183cm)		
9045 Adhesive Split Sheet	1	90" x 102" (228cm x 260cm)		
9088 Adhesive Drape Sheet (L)	1	98" x 59" (250cm x 150cm)		
9077 Back Table Cover	1	78" x 59" (200cm x 150cm)		

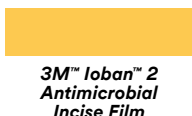

3M™ Steri-Drape™ ORTHOPAEDIC DRAPES

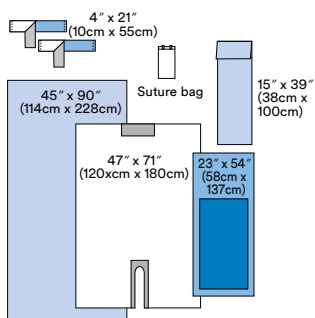
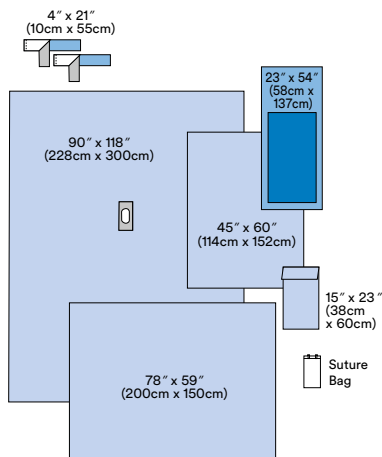
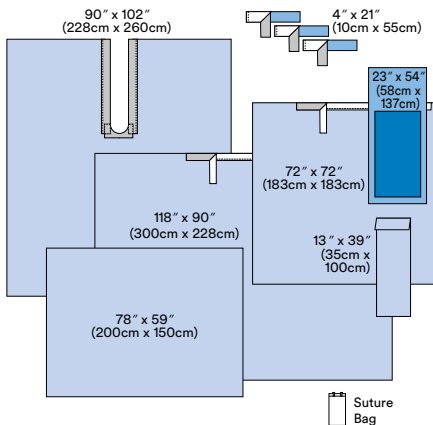

126" (320cm)

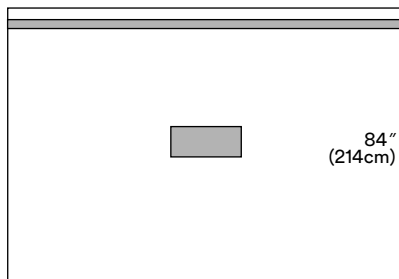

9012LA Orthopaedic Pack

Name	Quantity	Overall Size	Packs/Box	Boxes/Case
9012LA Orthopaedic Pack				
Suture Bag	1		4	2
9099 Operation Tapes	3	4" x 21" (10cm x 55cm)		
9036 Mayo Stand Cover	1	23" x 54" (58cm x 137cm)		
9042 Extremity Cover	1	15" x 39" (38cm x 100cm)		
9087 Adhesive Drape Sheet (M)	1	72" x 72" (183cm x 183cm)		
9045 Adhesive Split Sheet	1	90" x 102" (228cm x 260cm)		
9090 Adhesive Drape Sheet (XL)	1	118" x 90" (300cm x 228cm)		
9077 Back Table Cover	1	78" x 59" (200cm x 150cm)		

9014A Extremity Pack

Name	Quantity	Overall Size	Packs/Box	Boxes/Case
9014A Extremity Pack				
Suture Bag	1		5	2
9099 Operation Tapes	2	4" x 21" (10cm x 55cm)		
9036 Mayo Stand Cover	1	23" x 54" (58cm x 137cm)		
Drape Sheet	1	45" x 60" (114cm x 152cm)		
9041 Extremity Cover	1	15" x 23" (38cm x 60cm)		
9053 Extremity Drape	1	90" x 118" (228cm x 300cm)		
9077 Back Table Cover	1	78" x 59" (200cm x 150cm)		

9021A Orthopaedic Set-Up Pack

Name	Quantity	Overall Size	Packs/Box	Boxes/Case
9021A Orthopaedic Set-Up Pack				
Suture Bag	1		15	2
9036 Mayo Stand Cover	1	23" x 54" (58cm x 137cm)		
9099 Operation Tape	2	4" x 21" (10cm x 55cm)		
9042 Extremity Cover	1	15" x 39" (38cm x 100cm)		
1019 Long U-drape	1	47" x 71" (120cm x 180cm)		
Back Table Cover	1	45" x 90" (114cm x 228cm)		

1014 Patient Isolation Drape

Overall Size	Drapes/Box	Boxes/Case
126" x 84" (320cm x 214cm)	5	4
<ul style="list-style-type: none"> Incise area: 19" x 10" (48cm x 25cm) Adhesive strip along top 		
1014NS (non-sterile) <i>Custom Packs Only</i>	40 ea/cs	

KEY

Absorbent Prevention Fabric	Standard Blue Fabric (fluid-repellent)	Clear plastic film	3M™ Ioban™ 2 Antimicrobial Incise Film	3M™ Steri-Drape™ 2 Incise Film	Adhesive area

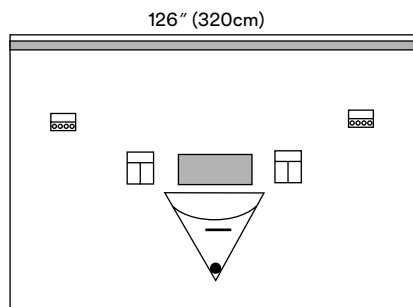

1017 Isolation Drape with Incise Film and Pouch

Overall Size	Drapes/Box	Boxes/Case
126" x 84" (320cm x 214cm)	5	4

- Incise area: 18" x 10" (48cm x 25cm)
- Fluid collection pouch with screen
- 1 – Exit port
- 2 – Instrument pouches
- 2 – Tube and cord organizers
- Adhesive strip along top

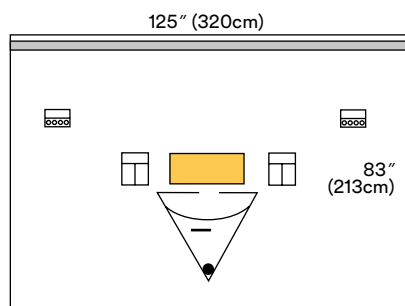

6617 Isolation Drape with loban™ 2 Incise Film and Pouch

Overall Size	Drapes/Box	Boxes/Case
125" x 83" (320cm x 213cm)	5	4

- loban 2 antimicrobial incise area: 19" x 9" (50cm x 24cm)
- Fluid collection pouch with screen
- 1 – Exit port
- 2 – Instrument pouches
- 2 – Tube and cord organizers
- Adhesive strip along top

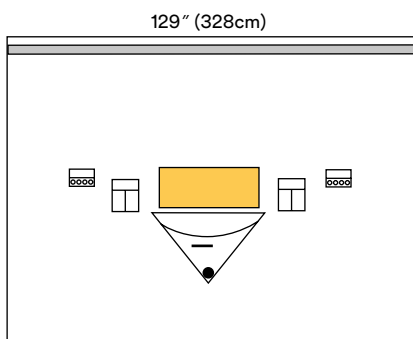

6619 Large Isolation Drape with loban 2 Incise Film and Pouch

Overall Size	Drapes/Box	Box/Case
129" x 100" (328cm x 254cm)	5	1

- loban 2 antimicrobial incise area: 27" x 12" (70cm x 32cm)
- Fluid collection pouch with screen
- 1 – Exit port
- 2 – Instrument pouches
- 2 – Tube and cord organizers

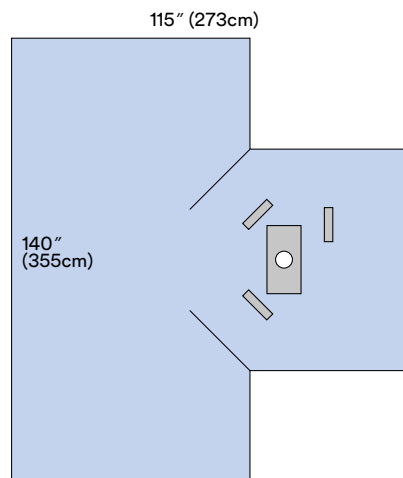

9052 Hand Drape

Overall Size	Drapes/Box	Boxes/Case
140" x 115" (355cm x 293cm)	9	2

- Elastic circle aperture: 1" (3cm)
- 3 – Tube and cord organizers

9052NS (non-sterile) <i>Custom Packs Only</i>	20 ea/cs
--	----------

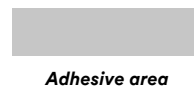

3M™ Steri-Drape™ ORTHOPAEDIC DRAPES

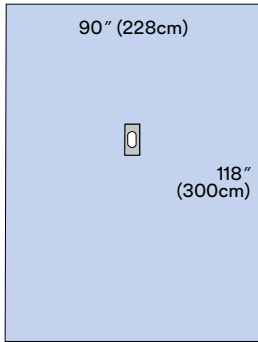

9053 Extremity Drape

Overall Size	Drapes/Box	Boxes/Case
90" x 118" (228cm x 300cm)	10	2
<ul style="list-style-type: none"> Elastic aperture: 2" x 3" (6cm x 8cm) 		
9053NS (non-sterile) <i>Custom Packs Only</i>	18 ea/cs	

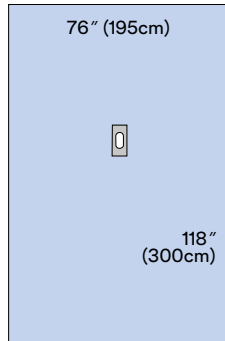

9054 Hand and Foot Drape

Overall Size	Drapes/Box	Boxes/Case
76" x 118" (195cm x 300cm)	15	2
<ul style="list-style-type: none"> Elastic aperture: 1" (3cm) 		
9054NS (non-sterile) <i>Custom Packs Only</i>	30 ea/cs	

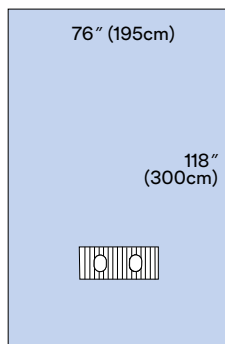

9056 Bilateral Foot Drape

Overall Size	Drapes/Box	Boxes/Case
76" x 118" (195cm x 300cm)	13	2
<ul style="list-style-type: none"> Elastic apertures: 1.5" (4cm) 		
9056NS (non-sterile) <i>Custom Packs Only</i>	28 ea/cs	

KEY

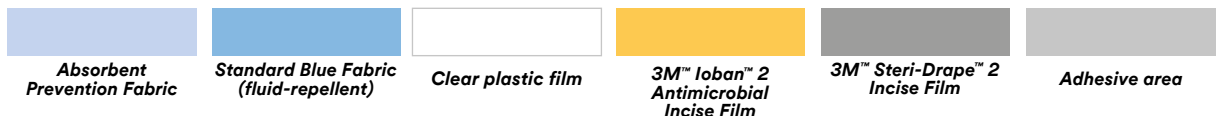

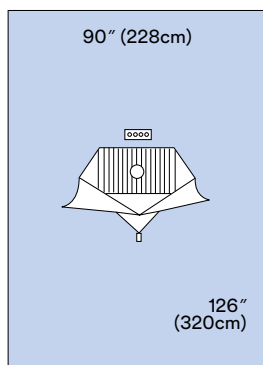

1094 Arthroscopy Sheet with Pouch

Overall Size	Drapes/Box	Boxes/Case
90" x 126" (228cm x 320cm)	20	1
<ul style="list-style-type: none"> • Fluid collection pouch • 2 – Exit ports • Tube and cord organiser 		
1094NS (non-sterile) <i>Custom Packs Only</i>	30 ea/cs	

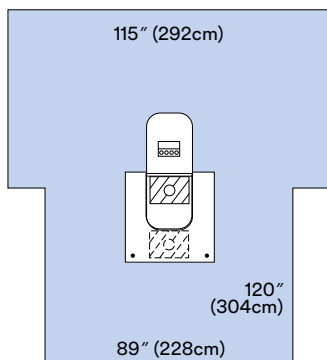

1194 Arthroscopy Sheet with Pouch

Overall Size	Drapes/Box	Boxes/Case
115" x 120" (292cm x 304cm)	5	1)
<ul style="list-style-type: none"> • Fluid collection pouch • 2 – Exit ports • Tube and cord organiser 		
1194NS (non-sterile) <i>Custom Packs Only</i>	36 ea/cs	

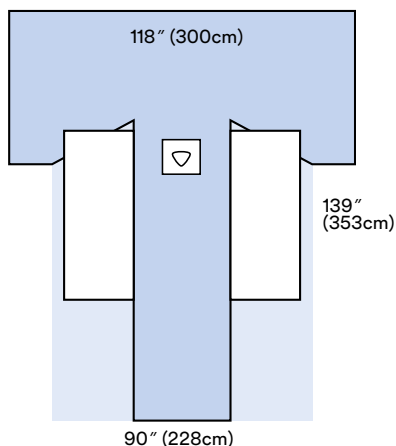

9055 Hip Drape with Pouches

Overall Size	Drapes/Box	Boxes/Case
118" x 139" (300cm x 353cm)	8	2
<ul style="list-style-type: none"> • Adhesive strip on the inside of the drape • Large side pockets with flaps for fluid collection and control 		
9055NS (non-sterile) <i>Custom Packs Only</i>	15 ea/cs	

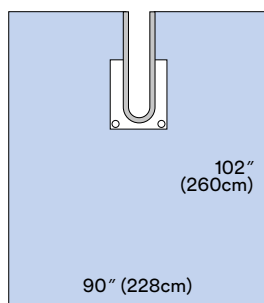

9196 Shoulder Split Sheet with Pouch

Overall Size	Drapes/Box	Boxes/Case
90" x 102" (228cm x 260cm)	10	2
<ul style="list-style-type: none"> • Adhesive split: 6" x 37" (16cm x 95cm) • Fluid control pouch with 2 exit ports 		
9196NS (non-sterile) <i>Custom Packs Only</i>	25 ea/cs	



3M™ Steri-Drape™ ORTHOPAEDIC DRAPES

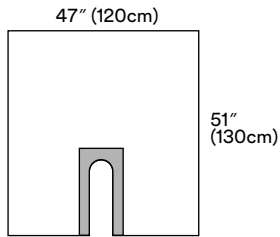

1015 U-drape

Overall Size	Drapes/Box	Boxes/Case
47" x 51" (120cm x 130cm)	10	4
<ul style="list-style-type: none"> • Adhesive split: 7" x 18" (16.5cm x 46cm) 		
1015NSD (non-sterile)	100 ea/cs	
1015NS (non-sterile) <i>Custom Packs Only</i>	200 ea/cs	

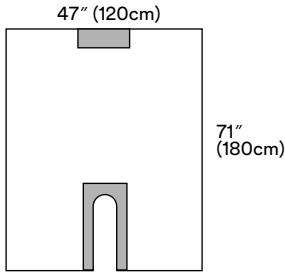

1019 Long U-drape

Overall Size	Drapes/Box	Boxes/Case
47" x 71" (120cm x 180cm)	10	4
<ul style="list-style-type: none"> • Adhesive split: 7" x 18" (16.5cm x 46cm) • Adhesive patch 		
1019NS (non-sterile) <i>Custom Packs Only</i>	200 ea/cs	

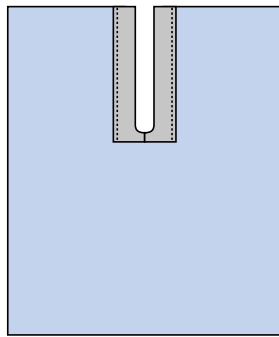

Adhesive Split Sheets

	Overall Size	Split Size	Drapes/Box	Boxes/Case
9043	60" x 72" (152cm x 183cm)	2.5" x 25" (7x70cm)	30	2
9044	60" x 98" (152cm x 250cm)	2.5" x 25" (7x70cm)	25	2
9045	90" x 102" (228cm x 260cm)	8" x 39" (20cm x 100cm)	15	2
9043NS (non-sterile) <i>Custom Packs Only</i>			68 ea/cs	
9044NS (non-sterile) <i>Custom Packs Only</i>			58 ea/cs	
9045NS (non-sterile) <i>Custom Packs Only</i>			30 ea/cs	

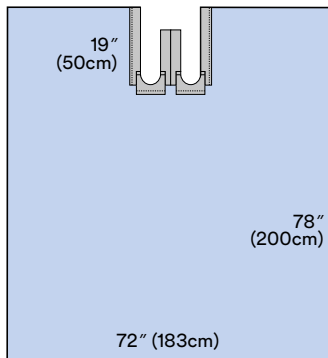

9046 Bilateral Adhesive Split Sheet

Overall Size	Drapes/Box	Boxes/Case
72" x 78" (183cm x 200cm)	15	2
<ul style="list-style-type: none"> • Double adhesive split: 6" x 19" (15cm x 50cm) 		
9046NS (non-sterile) <i>Custom Packs Only</i>	30 ea/cs	

KEY

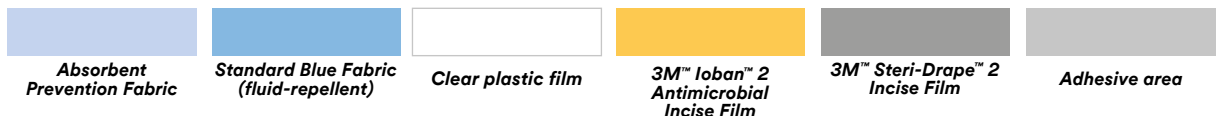

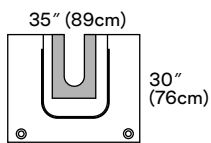

1067 U-pouch

Overall Size	Drapes/Box	Boxes/Case
35" x 30" (89cm x 76cm)	5	4
<ul style="list-style-type: none"> • Adhesive split: 6" x 15" (16cm x 40cm) • Fluid collection pouch • 2 – Exit ports 		
1067NS (non-sterile) <i>Custom Packs Only</i>	50 ea/cs	

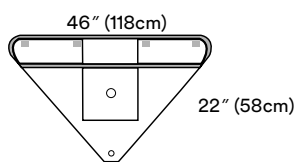

1007 Arthroscopy Fluid Collection Pouch

Overall Size	Drapes/Box	Boxes/Case
46" x 22" (118cm x 58cm)	10	4
<ul style="list-style-type: none"> • Adhesive strip • 1 – Exit port 		

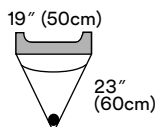

1016 Irrigation Pouch

Overall Size	Drapes/Box	Boxes/Case
19" x 23" (50cm x 60cm)	10	4
<ul style="list-style-type: none"> • Adhesive strip • 1 – Exit port • Screen 		
1016NS (non-sterile) <i>Custom Packs Only</i>	200 ea/cs	

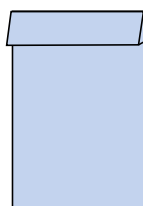

Extremity Covers

	Overall Size	Drapes/Box	Boxes/Case
9043	15" x 23" (38cm x 60cm)	50	4
9044	15" x 39" (38cm x 100cm)	35	4
9041NS (non-sterile) <i>Custom Packs Only</i>		380 ea/cs	
9042NS (non-sterile) <i>Custom Packs Only</i>		250 ea/cs	



CARDIOVASCULAR/CARDIAC CATHETERIZATION DRAPES

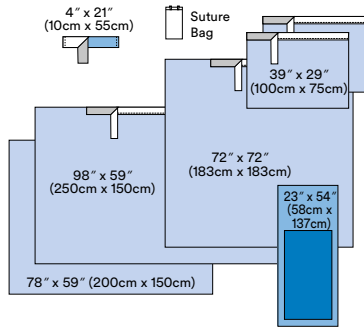

9000A Basic Surgical Pack

Name	Quantity	Overall Size	Packs/Box	Boxes/Case
9000A Basic Surgical Pack			7	2
Suture Bag	1			
9099 Operation Tape	1	4" x 21" (10cm x 55cm)		
9036 Mayo Stand Cover	1	23" x 54" (58cm x 137cm)		
9086 Adhesive Towel Drapes	2	39" x 30" (100cm x 76cm)		
9087 Adhesive Drape Sheet (M)	1	72" x 72" (183cm x 183cm)		
9088 Adhesive Drape Sheet (L)	1	98" x 59" (250cm x 150cm)		
9077 Back Table Cover	1	78" x 59" (200cm x 150cm)		

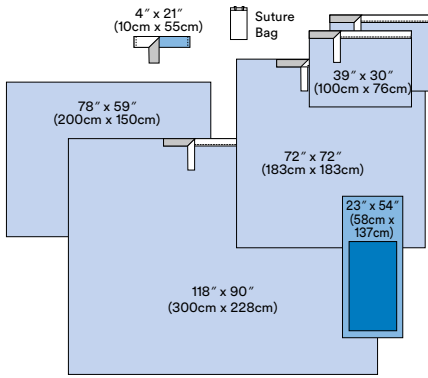

9000LA Basic Surgical Pack

Name	Quantity	Overall Size	Packs/Box	Boxes/Case
9000LA Basic Surgical Pack			5	2
Suture Bag	1			
9099 Operation Tape	1	4" x 21" (10cm x 55cm)		
9036 Mayo Stand Cover	1	23" x 54" (58cm x 137cm)		
9086 Adhesive Towel Drapes	2	39" x 30" (100cm x 76cm)		
9087 Adhesive Drape Sheet (M)	1	72" x 72" (183cm x 183cm)		
9090 Adhesive Drape Sheet (XL)	1	118" x 90" (300cm x 228cm)		
Back Table Cover	1	78" x 59" (200cm x 150cm)		

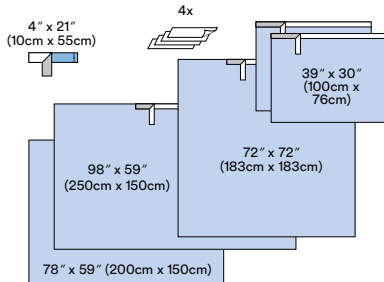

9010 Basic Surgical Pack without Mayo Stand Cover

Name	Quantity	Overall Size	Packs/Box	Boxes/Case
9010 Basic Surgical Pack without Mayo Stand Cover			7	2
9099 Operation Tape	1	4" x 21" (10cm x 55cm)		
Hand Towels	4	-		
9085 Adhesive Towel Drapes	2	39" x 33" (100cm x 85cm)		
9087 Adhesive Drape Sheet (M)	1	72" x 72" (183cm x 183cm)		
9088 Adhesive Drape Sheet (L)	1	98" x 59" (250cm x 150cm)		
9077 Back Table Cover	1	78" x 59" (200cm x 150cm)		



Absorbent Prevention Fabric	Standard Blue Fabric (fluid-repellent)	Clear plastic film	3M™ Ioban™ 2 Antimicrobial Incise Film	3M™ Steri-Drape™ 2 Incise Film	Adhesive area

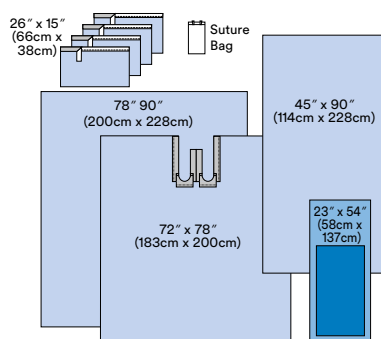

9022A Cardiovascular Set-Up Pack

Name	Quantity	Overall Size	Packs/Box	Boxes/Case
9022A Cardiovascular Set-Up Pack				
Suture Bag	1		7	2
9036 Mayo Stand Cover	1	23" x 54" (58cm x 137cm)		
9079 Back Table Cover	1	78" x 90" (200cm x 228cm)		
Utility Drapes	4	26" x 15" (66cm x 38cm)		
9046 Bilateral Split Sheet	1	72" x 78" (183cm x 200cm)		
Back Table Cover	1	45" x 90" (114cm x 228cm)		

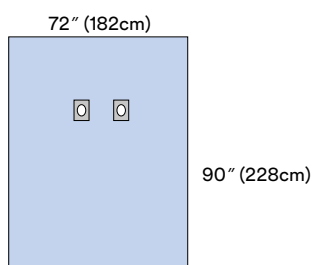

1090 Femoral Angiography Drape

Overall Size	Drapes/Box	Boxes/Case
72" x 90" (182cm x 228cm)	20	1
<ul style="list-style-type: none"> • 2 – Adhesive patches: 4" x 6" (11.4cm x 14cm) • 2 – Oval apertures: 3" x 4" (6.4cm x 8.9cm) 		

1090NS (non-sterile) *Custom Packs Only* 50 ea/cs

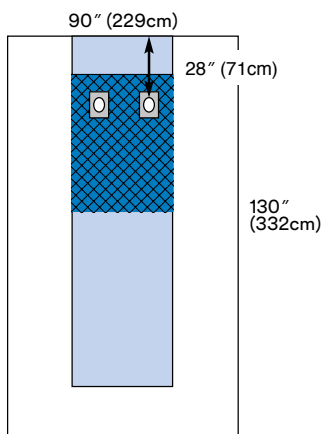

1191 Femoral Angiography Drape

Overall Size	Drapes/Box	Boxes/Case
90" x 130" (228cm x 330cm)	20	1
<ul style="list-style-type: none"> • 2 – Adhesive patches: 4" x 6" (11.4cm x 14cm) • 2 – Oval apertures: 3" x 4" (7.6cm x 10.2cm) • Extra-absorbent critical zone • Transparent side and end panels 		

• **Absorbent Fabric** 20 ea/cs

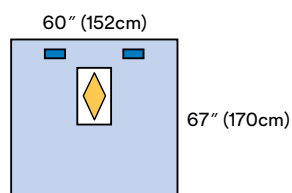

1192 Venous/Arterial Access Drape

Overall Size	Drapes/Box	Boxes/Case
60" x 67" (152cm x 170cm)	12	4
<ul style="list-style-type: none"> • Designed for a variety of procedures, including: pacemaker insertion and repairs, brachial and radial artery access, radial artery harvesting, and central and PICC line insertions • Aperture: 152cm x 170cm (60" x 67") 		

1192NS (non-sterile) *Custom Packs Only* 68 ea/cs

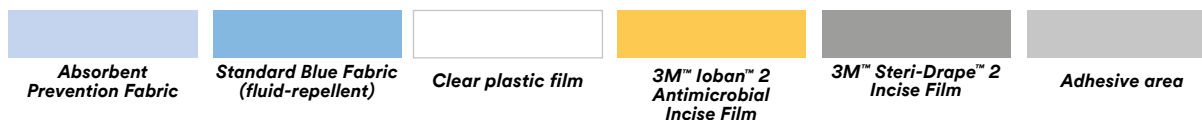

CARDIOVASCULAR/CARDIAC CATHETERIZATION DRAPES

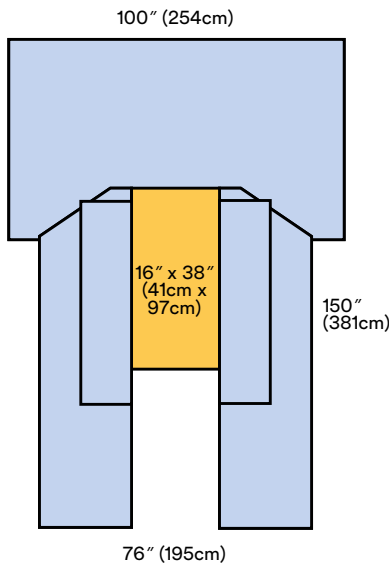

6677 Cardiovascular Sheet with loban 2 Incise Film

Overall Size	Drapes/Box	Boxes/Case
100" x 150" (254cm x 381cm)	6	1

- loban 2 antimicrobial incise area: 16" x 38" (41cm x 97cm)
- Dual side pockets
- Reinforced anesthesia screen

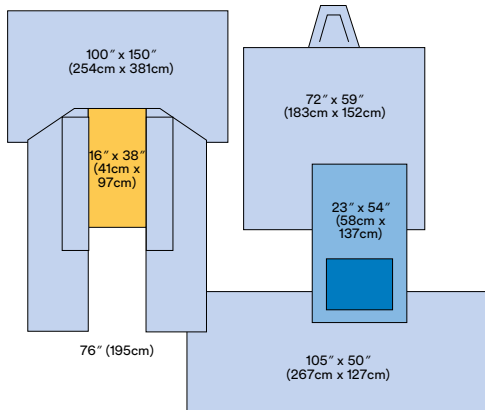

6678 Cardiovascular Pack

Name	Quantity	Overall Size	Packs/Box	Boxes/Case
6678 Cardiovascular Pack				
6677 Steri-Drape Cardiovascular Sheet with loban 2 Incise Film	1	100" x 150" (254cm x 381cm)	4	1
1083 Perineal/Leg Sheet	1	72" x 59" (183cm x 152cm)		
9036 Mayo Stand Cover	1	23" x 54" (58cm x 137cm)		
Back Table Cover	1	105" x 50" (267cm x 127cm)		

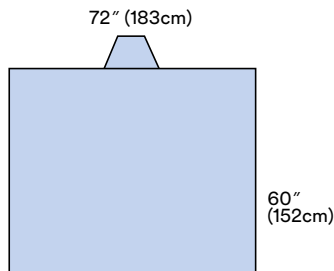

1083 Perineal/Leg Sheet

Overall Size	Drapes/Box	Boxes/Case
72" x 59" (183cm x 152cm)	50	2

1083NS (non-sterile) Custom Packs Only

90 ea/cs

KEY

 Absorbent Prevention Fabric

 Standard Blue Fabric (fluid-repellent)

 Clear plastic film

 3M™ loban™ 2 Antimicrobial Incise Film

 3M™ Steri-Drape™ 2 Incise Film

 Adhesive area

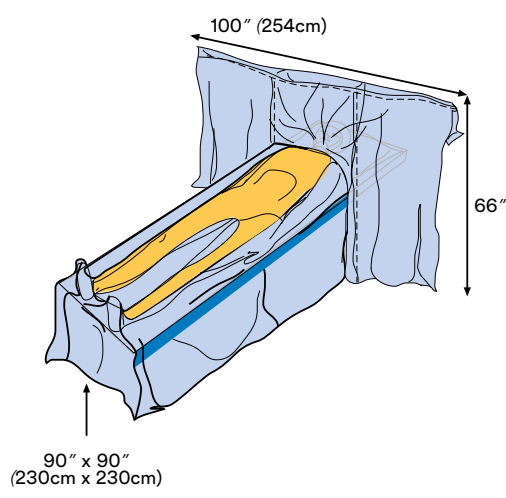

6681 Cardiovascular Drape with loban 2 Incise Film

Overall Size	Drapes/Box	Box/Case
100" x 151" (254cm x 384cm)	8	1

- loban 2 antimicrobial incise area: 16" x 61" (41cm x 154cm)
- One-piece design
- Expansion pleat between legs
- Blue anesthesia screen
- loban 2 antimicrobial incise film in both chest and leg areas

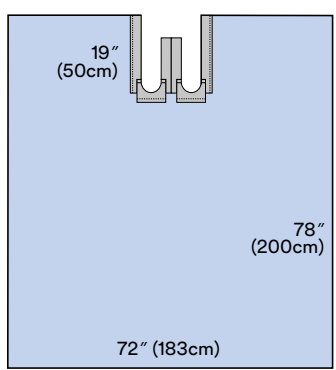

9046 Bilateral Adhesive Split Sheet

Overall Size	Drapes/Box	Boxes/Case
72" x 78" (183cm x 200cm)	15	2

- Double adhesive split: 5 7/8" x 19" (15cm x 50cm)

9046NS (non-sterile) <i>Custom Packs Only</i>	30 ea/cs	
--	----------	--

Absorbent Prevention Fabric	Standard Blue Fabric (fluid-repellent)	Clear plastic film	3M™ Ioban™ 2 Antimicrobial Incise Film	3M™ Steri-Drape™ 2 Incise Film	Adhesive area



OBSTETRICS AND GYNAECOLOGY DRAPES

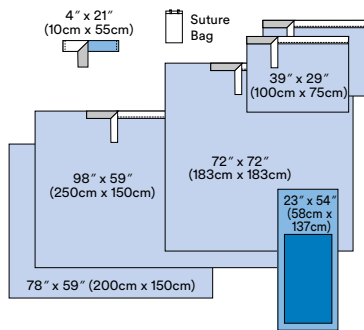

9000A Basic Surgical Pack

Name	Quantity	Overall Size	Packs/Box	Boxes/Case
9000A Basic Surgical Pack				
Suture Bag	1		7	2
9099 Operation Tape	1	4" x 21" (10cm x 55cm)		
9036 Mayo Stand Cover	1	23" x 54" (58cm x 137cm)		
9086 Adhesive Towel Drapes	2	39" x 30" (100cm x 76cm)		
9087 Adhesive Drape Sheet (M)	1	72" x 72" (183cm x 183cm)		
9088 Adhesive Drape Sheet (L)	1	98" x 59" (250cm x 150cm)		
9077 Back Table Cover	1	78" x 59" (200cm x 150cm)		

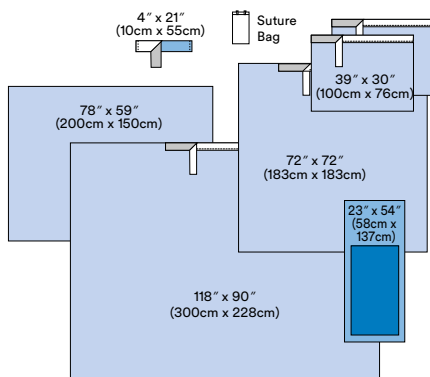

9000LA Basic Surgical Pack

Name	Quantity	Overall Size	Packs/Box	Boxes/Case
9000LA Basic Surgical Pack				
Suture Bag	1		5	2
9099 Operation Tape	1	4" x 21" (10cm x 55cm)		
9036 Mayo Stand Cover	1	23" x 54" (58cm x 137cm)		
9086 Adhesive Towel Drapes	2	39" x 30" (100cm x 76cm)		
9087 Adhesive Drape Sheet (M)	1	72" x 72" (183cm x 183cm)		
9090 Adhesive Drape Sheet (XL)	1	118" x 90" (300cm x 228cm)		
9077 Back Table Cover	1	78" x 59" (200cm x 150cm)		

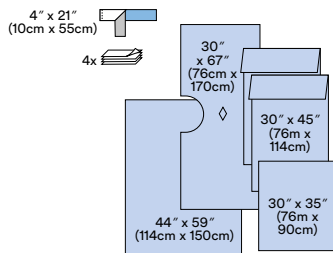

9003 Cystoscopy Pack

Name	Quantity	Overall Size	Packs/Box	Boxes/Case
9003 Cystoscopy Pack				
9099 Operation Tape	1	4" x 21" (10cm x 55cm)	10	2
Hand Towels	4	-		
9040 Leggings (pair)	1	30" x 45" (76cm x 114cm)		
9069 Drape Sheet	1	30" x 35" (76cm x 90cm)		
9023 Perineal Aperture Drape	1	30" x 67" (76cm x 170cm)		
9072 Back Table Cover	1	44" x 59" (114cm x 150cm)		

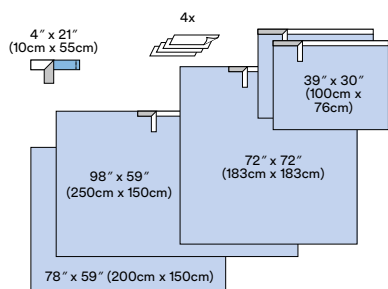

9010 Basic Surgical Pack without Mayo Stand Cover

Name	Quantity	Overall Size	Packs/Box	Boxes/Case
9010 Basic Surgical Pack without Mayo Stand Cover				
9099 Operation Tape	1	4" x 21" (10cm x 55cm)	7	2
Hand Towels	4	-		
9085 Adhesive Towel Drapes	2	39" x 33" (100cm x 85cm)		
9087 Adhesive Drape Sheet (M)	1	72" x 72" (183cm x 183cm)		
9088 Adhesive Drape Sheet (L)	1	98" x 59" (250cm x 150cm)		
9077 Back Table Cover	1	78" x 59" (200cm x 150cm)		

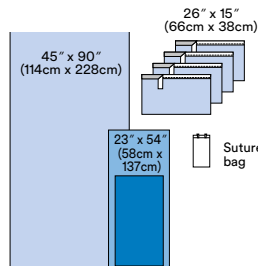

9020A Basic Set-Up Pack

Name	Quantity	Overall Size	Packs/Box	Boxes/Case
9020A Basic Set-Up Pack				
Suture Bag	1		20	2
9036 Mayo Stand Cover	1	23" x 54" (58cm x 137cm)		
Utility Drapes	4	26" x 15" (66cm x 38cm)		
Back Table Cover	1	45" x 90" (114cm x 228cm)		



Absorbent Prevention Fabric	Standard Blue Fabric (fluid-repellent)	Clear plastic film	3M™ Ioban™ 2 Antimicrobial Incise Film	3M™ Steri-Drape™ 2 Incise Film	Adhesive area

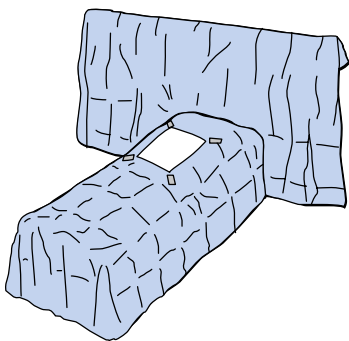

1031 Laparoscopic Drape/Supine Position

Overall Size	Drapes/Box	Boxes/Case
112" x 90" (285cm x 228cm)	10	2
<ul style="list-style-type: none"> • Adhesive aperture: 10" x 11" (27cm x 30cm) • 4 – Tube organizers (ref.1115) 		
1031NS (non-sterile) <i>Custom Packs Only</i>	30 ea/cs	

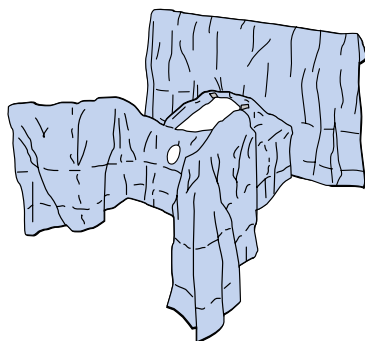

1032 Laparoscopic Drape/Lithotomy Position

Overall Size	Drapes/Box	Boxes/Case
95" x 90" (241cm x 228cm)	8	2
<ul style="list-style-type: none"> • Adhesive aperture: 11" x 12" (27cm x 30cm) • Peri/vag. aperture: 5" x 6" (12cm x 15.5cm) • Leggings: 46" (117cm) • 4 – Tube organizers (ref.1115) 		
1032NS (non-sterile) <i>Custom Packs Only</i>	20 ea/cs	

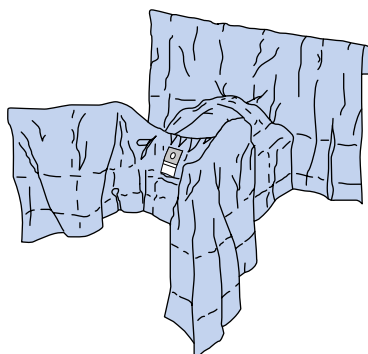

1080 Gynaecology Drape

Overall Size	Drapes/Box	Boxes/Case
77" x 70" (195cm x 179cm)	14	2
<ul style="list-style-type: none"> • Peri/vag. aperture: 4" x 5" (9cm x 12cm) • Tube and cord organizers (ref.1115) • Fluid collection pouch (ref.) 		
1080NS (non-sterile) <i>Custom Packs Only</i>	30 ea/cs	
Leggings 46" (117cm)		



2065 Abdominoperineal Incise Drape

Overall Size	Drapes/Box	Boxes/Case
77" x 160" (195cm x 271cm)	8	2
<ul style="list-style-type: none"> • Steri-Drape 2 incise area: 16" x 17.5" (41cm x 45cm) • Peri/vag. aperture: 5" x 6" (12cm x 15.5cm) • Tube and cord organizers (ref.1115) 		
2065NS (non-sterile) <i>Custom Packs Only</i>	20 ea/cs	



OBSTETRICS AND GYNAECOLOGY DRAPES

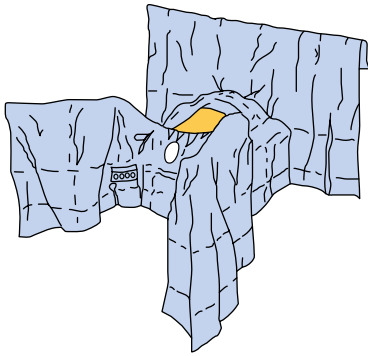

6665 Abdominal-Perineal Drape with loban 2 Incise Film – Lithotomy Position

Overall Size	Drapes/Box	Boxes/Case
78" x 107" (200cm x 274cm)	5	1

- loban 2 antimicrobial incise area: 13" x 17" (33cm x 45cm)
- Peri/vag. aperture: 4⁵/₈" x 6" (12cm x 15.5cm)
- Tube and cord organizers (ref.1115)

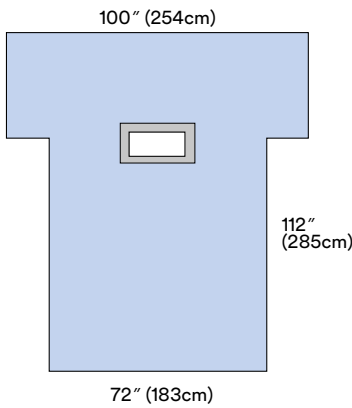

9062 Laparotomy Drape (Transverse)

Overall Size	Drapes/Box	Boxes/Case
72" x 112" (183cm x 285cm)	12	2

- Aperture: 12" x 4" (30cm x 10cm)

9062NS (non-sterile) <i>Custom Packs Only</i>	30 ea/cs	
--	----------	--

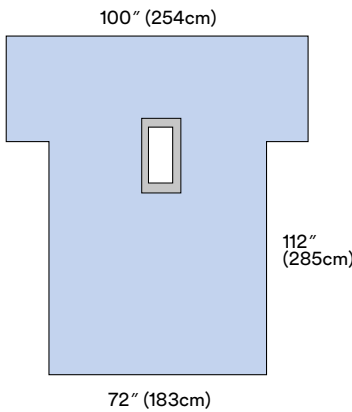

9063 Laparotomy Drape

Overall Size	Drapes/Box	Boxes/Case
100" x 112" (254cm x 285cm)	10	2

- Aperture: 4" x 12" (10cm x 30cm)

9063NS (non-sterile) <i>Custom Packs Only</i>	30 ea/cs	
--	----------	--

KEY

 Absorbent Prevention Fabric

 Standard Blue Fabric (fluid-repellent)

 Clear plastic film

 3M™ loban™ 2 Antimicrobial Incise Film

 3M™ Steri-Drape™ 2 Incise Film

 Adhesive area

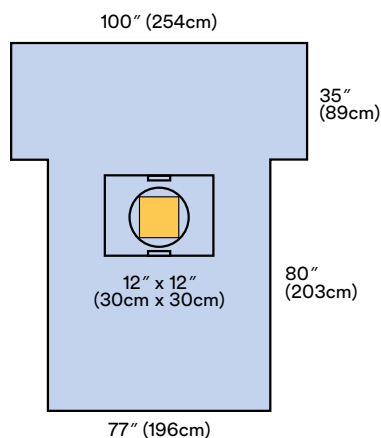

6697 Cesarean Section Sheet with loban 2 Incise Pouch

Overall Size	Drapes/Box	Box/Case
100" x 115" (254cm x 292cm)	5	1

- loban 2 antimicrobial incise area: 12" x 12" (30cm x 30cm)
- 360-degree fluid collection pouch
- Tube and cord organizers

6697CA Cesarean-Section Drape with loban 2 Incise Pouch and Clear Anesthesia Screen

Overall Size	Drapes/Box	Box/Case
100" x 115" (254cm x 292cm)	5	1

- loban 2 antimicrobial incise area: 12" x 12" (30cm x 30cm)
- Clear anesthesia screen allows mother to see the birth
- 360-degree fluid collection pouch
- Tube and cord organizers

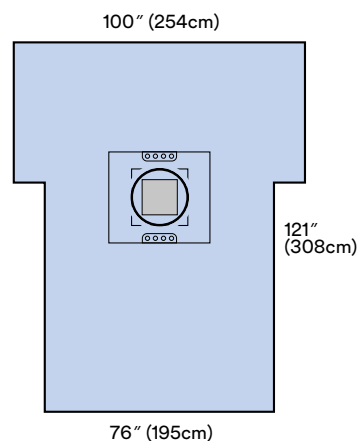

7965 Cesarean Section Drape with Incise Sheet with Pouch

Overall Size	Drapes/Box	Boxes/Case
100" x 121" (254cm x 308cm)	5	1

- Incise area: 12" x 12" (30cm x 30cm)
- 360-degree fluid collection pouch
- Tube and cord organizers

7965NS (non-sterile) <i>Custom Packs Only</i>	18 ea/cs
--	----------

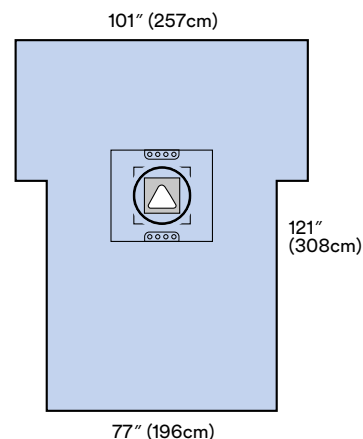

7966 Cesarean Section Sheet with Aperture Pouch

Overall Size	Drapes/Box	Boxes/Case
60" x 121" (254cm x 308cm)	5	1

- Aperture incise area: 12" x 12" (30cm x 30cm)
- 360-degree fluid collection pouch
- Tube and cord organizers

7966NS (non-sterile) <i>Custom Packs Only</i>	18 ea/cs
--	----------

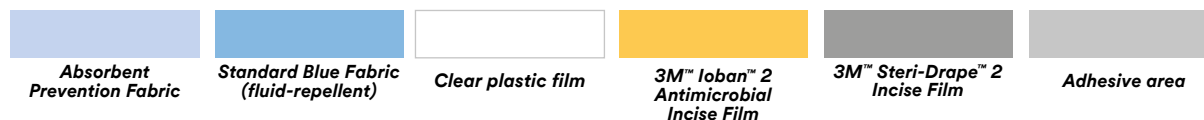

OBSTETRICS AND GYNAECOLOGY DRAPES

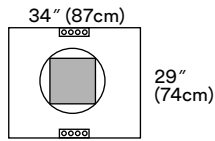

2057 Incise Pouch

Overall Size	Drapes/Box	Boxes/Case
34" x 29" (87cm x 74cm)	10	4

- Incise area: 12" x 12" (30cm x 30cm)
- 360-degree fluid collection pouch
- Tube and cord organizers

2057NS (non-sterile) <i>Custom Packs Only</i>	100 ea/cs
--	-----------

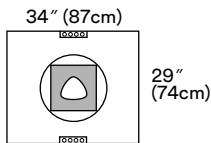

2058 Aperture Pouch Drape

Overall Size	Drapes/Box	Boxes/Case
34" x 29" (87cm x 74cm)	10	4

- Aperture incise area: 12" x 12" (30cm x 30cm)
- 360-degree fluid collection pouch
- Tube and cord organizers

2058NS (non-sterile) <i>Custom Packs Only</i>	100 ea/cs
--	-----------

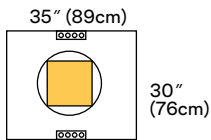

6657 Pouch with Ioban 2 Incise Film

Overall Size	Drapes/Box	Boxes/Case
34" x 29" (87cm x 74cm)	10	4

- Ioban 2 antimicrobial incise area: 11" x 11" (30cm x 30cm)
- 360-degree fluid collection pouch
- Tube and cord organizers

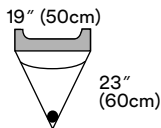

1016 Irrigation Pouch

Overall Size	Drapes/Box	Boxes/Case
Size: 19" x 23" (50cm x 60cm)	10	4

- Adhesive strip
- 1 – Exit port
- Screen

1016NS (non-sterile) <i>Custom Packs Only</i>	200 ea/cs
--	-----------

KEY

 Absorbent Prevention Fabric

 Standard Blue Fabric (fluid-repellent)

 Clear plastic film

 3M™ Ioban™ 2 Antimicrobial Incise Film

 3M™ Steri-Drape™ 2 Incise Film

 Adhesive area

9" (23cm)

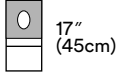

1072 Aperture Pouch Drape

Overall Size	Packs/Box	Boxes/Case
9" x 17" (23cm x 45cm)	10	4
<ul style="list-style-type: none"> • Adhesive area: 9" x 10" (23cm x 25cm) • Oval aperture: 3.5" x 4.25" (9cm x 11cm) • Fluid collection pouch 		
1072NS (non-sterile) <i>Custom Packs Only</i>	200 ea/cs	

34" (86cm)

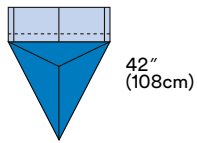

1084 Under Buttocks Drape with Pouch

Overall Size	Drapes/Box	Boxes/Case
34" x 42" (86cm x 108cm)	30	4
<ul style="list-style-type: none"> • Cuff size: 10" (25.4cm) • Fluid collection pouch 		
1084NS (non-sterile) <i>Custom Packs Only</i>	140 ea/cs	

29" (75cm)

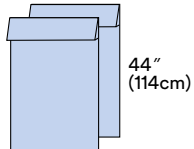

9040 Leggings (2)

Overall Size	Drapes/Box	Boxes/Case
29" x 44" (75cm x 114cm)	10	4
9040NS (non-sterile) <i>Custom Packs Only</i>	116 ea/cs	

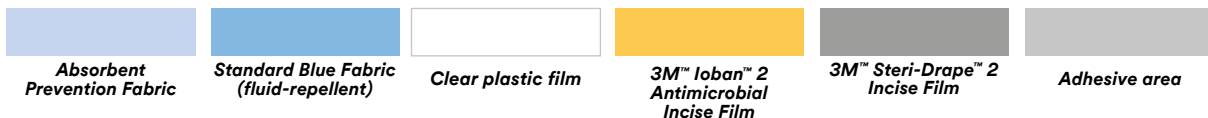

3M™ Steri-Drape™ EENT DRAPES

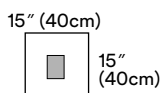
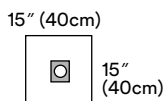
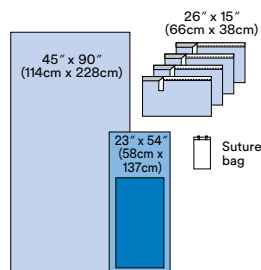
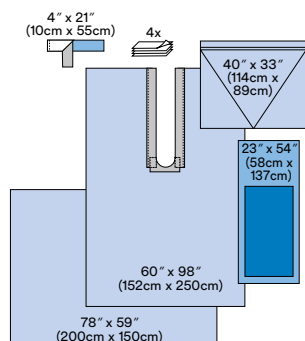
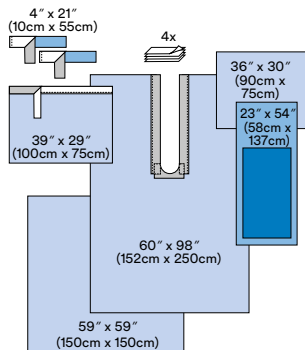

9007A ENT Pack

Name	Quantity	Overall Size	Packs/Box	Boxes/Case
9007A ENT Pack				
9099 Operation Tape	2	4" x 21" (10cm x 55cm)	8	2
9036 Mayo Stand Cover	1	23" x 54" (58cm x 137cm)		
9069 Drape Sheet	1	35" x 30" (90cm x 76cm)		
9044 Adhesive Split Sheet	1	60" x 98" (152cm x 250cm)		
9086 Adhesive Towel Drape	1	39" x 30" (100cm x 76cm)		
9074 Back Table Cover	1	59" x 59" (150cm x 150cm)		

9008A Head and Neck Pack

Name	Quantity	Overall Size	Packs/Box	Boxes/Case
9008A Head and Neck Pack				
9099 Operation Tape	1	4" x 21" (10cm x 55cm)	8	2
9036 Mayo Stand Cover	1	23" x 54" (58cm x 137cm)		
9070 Turban Drape Sheet	1	40" x 33" (114cm x 89cm)		
9044 Adhesive Split Sheet	1	60" x 98" (152cm x 250cm)		
9077 Back Table Cover	1	78" x 59" (200cm x 150cm)		

9020A Basic Set-Up Pack

Name	Quantity	Overall Size	Packs/Box	Boxes/Case
9020A Basic Set-Up Pack				
Suture Bag	1		20	2
9036 Mayo Stand Cover	1	23" x 54" (58cm x 137cm)		
Utility Drapes	4	26" x 15" (66cm x 38cm)		
Back Table Cover	1	45" x 90" (114cm x 228cm)		

1020 Small Drape with Adhesive Aperture

Overall Size	Drapes/Box	Boxes/Case
15" x 15" (40cm x 40cm)	10	4
<ul style="list-style-type: none"> Adhesive area: 3⁷/₈" x 4⁷/₈" (10cm x 12.5cm) Circle aperture: 2³/₈" (6.3cm) 		
1020NS (non-sterile) <i>Custom Packs Only</i>	200 ea/cs	

1021 Small Drape with Incise Film

Overall Size	Drapes/Box	Boxes/Case
15" x 15" (40cm x 40cm)	10	4
<ul style="list-style-type: none"> Incise area: 3⁷/₈" x 4⁷/₈" (10cm x 12.5cm) 		
1021NS (non-sterile) <i>Custom Packs Only</i>	200 ea/cs	

KEY

Absorbent Prevention Fabric

Standard Blue Fabric (fluid-repellent)

Clear plastic film

3M™ Ioban™ 2 Antimicrobial Incise Film

3M™ Steri-Drape™ 2 Incise Film

Adhesive area

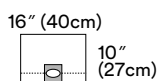

1022 Refractive Drape

Overall Size	Drapes/Box	Boxes/Case
16" x 11" (40cm x 27.5cm)	20	4
<ul style="list-style-type: none"> • Adhesive area: 3" x 3" (7.2cm x 7.2cm) • Oval aperture: 2" x 2" (4.4cm x 3.8cm) • Perforated 		
1022NS (non-sterile) <i>Custom Packs Only</i>	200 ea/cs	

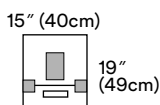

1023 Small Drape with Incise Film and Pouch

Overall Size	Drapes/Box	Boxes/Case
15" x 19" (40cm x 49cm)	10	4
<ul style="list-style-type: none"> • Incise area: 4" x 5" (10cm x 12.5cm) • 2 – Adhesive patches • Fluid collection pouch 		
1023NS (non-sterile) <i>Custom Packs Only</i>	200 ea/cs	

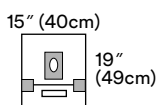

1024 Small Drape with Adhesive Aperture and Pouch

Overall Size	Drapes/Box	Boxes/Case
15" x 19" (40cm x 49cm)	10	4
<ul style="list-style-type: none"> • Adhesive area: 4" x 5" (10cm x 12.5cm) • Oval aperture: 1" x 2" (3.5cm x 6.3cm) • 2 – Adhesive patches • Fluid collection pouch 		
1024NS (non-sterile) <i>Custom Packs Only</i>	200 ea/cs	

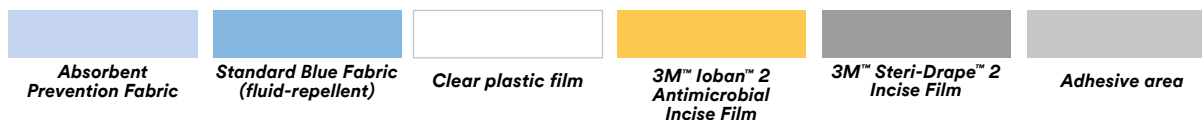

3M™ Steri-Drape™ EENT DRAPES

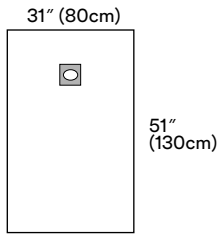

1030 Medium Drape with Adhesive Aperture

Overall Size	Drapes/Box	Boxes/Case
31" x 51" (80cm x 130cm)	10	4
<ul style="list-style-type: none"> • Adhesive area: 3⁷/₈" x 4⁷/₈" (10cm x 12.5cm) • Oval aperture: 2" x 2⁷/₈" (5.2cm x 7.6cm) 		
1030NS (non-sterile) <i>Custom Packs Only</i>	200 ea/cs	

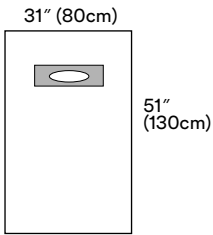

1033 Medium Drape with Wide Adhesive Aperture

Overall Size	Drapes/Box	Boxes/Case
31" x 51" (80cm x 130cm)	10	4
<ul style="list-style-type: none"> • Adhesive area: 9" x 4" (22.9cm x 11.4cm) • Oval aperture: 7" x 3" (17.1cm x 6.7cm) 		
1033NS (non-sterile) <i>Custom Packs Only</i>	200 ea/cs	

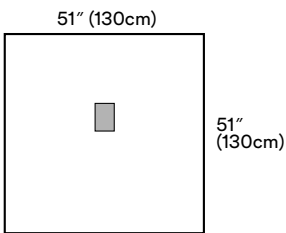

1060 Medium Drape with Incise Film

Overall Size	Drapes/Box	Boxes/Case
51" x 51" (130cm x 130cm)	10	4
<ul style="list-style-type: none"> • Incise area: 4" x 5" (10cm x 12.5cm) 		
1060NS (non-sterile) <i>Custom Packs Only</i>	200 ea/cs	

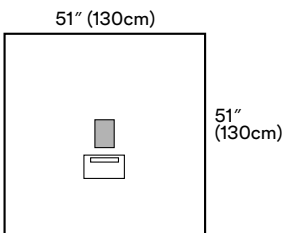

1061 Medium Drape with Incise Film and Pouch

Overall Size	Drapes/Box	Boxes/Case
51" x 51" (130cm x 130cm)	10	4
<ul style="list-style-type: none"> • Incise area: 4" x 5" (10cm x 12.5cm) • Fluid collection pouch 		
1061NS (non-sterile) <i>Custom Packs Only</i>	200 ea/cs	

KEY

 Absorbent Prevention Fabric

 Standard Blue Fabric (fluid-repellent)

 Clear plastic film

 3M™ Ioban™ 2 Antimicrobial Incise Film

 3M™ Steri-Drape™ 2 Incise Film

 Adhesive area

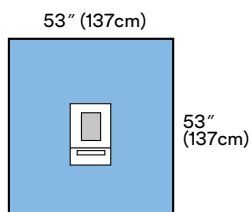

1062 Ophthalmic Incise Drape with Pouch

Overall Size	Drapes/Box	Boxes/Case
53" x 53" (137cm x 137cm)	30	2
<ul style="list-style-type: none"> • Incise area: 3" x 4" (8cm x 10cm) • Fluid collection pouch 		
1062NS (non-sterile) <i>Custom Packs Only</i>	100 ea/cs	

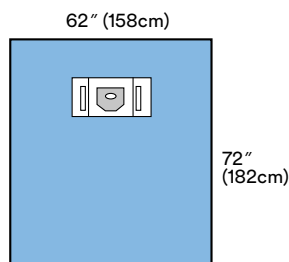

1064 Ophthalmic Sheet with Aperture and Pouches

Overall Size	Drapes/Box	Boxes/Case
62" x 72" (158cm x 182cm)	20	2
<ul style="list-style-type: none"> • Adhesive area: 2" x 1" (6cm x 3cm) • Oval aperture: 2" x 1" (6cm x 3cm) • 2 – Fluid collection pouches 		
1064NS (non-sterile) <i>Custom Packs Only</i>	54 ea/cs	

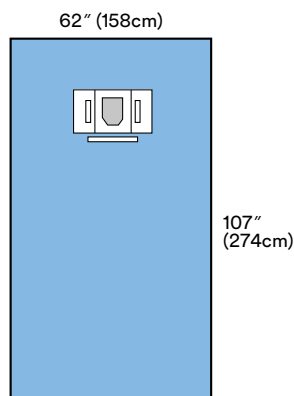

1055B Large Ophthalmic Sheet with Incise Film and Pouches

Overall Size	Drapes/Box	Boxes/Case
62" x 108" (158cm x 274cm)	14	2
<ul style="list-style-type: none"> • Incise area: 4" x 5" (9cm x 12cm) • 2 – Fluid collection pouches • Face arch 		
1055NS (non-sterile) <i>Custom Packs Only</i>	35 ea/cs	

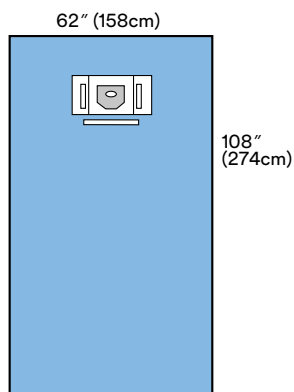

1065B Large Ophthalmic Sheet with Aperture and Pouches

Overall Size	Drapes/Box	Boxes/Case
62" x 108" (158cm x 274cm)	14	2
<ul style="list-style-type: none"> • Adhesive area: 4" x 5" (9cm x 11.7cm) • Oval aperture: 2" x 1" (6cm x 3cm) • 2 – Fluid collection pouches • Face arch 		
1065NS (non-sterile) <i>Custom Packs Only</i>	35 ea/cs	

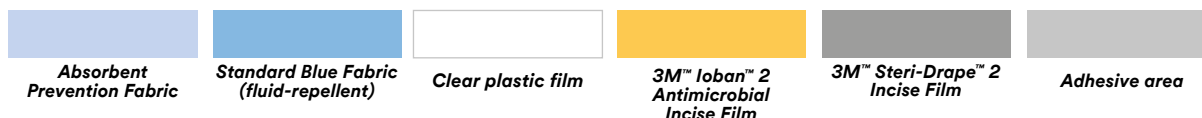

3M™ Steri-Drape™ GENERAL SURGERY DRAPES

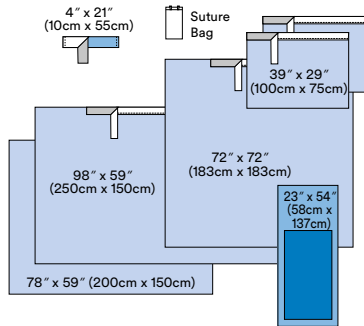

9000A Basic Surgical Pack

Name	Quantity	Overall Size	Packs/Box	Boxes/Case
9000A Basic Surgical Pack			7	2
Suture Bag	1			
9099 Operation Tape	1	4" x 21" (10cm x 55cm)		
9036 Mayo Stand Cover	1	23" x 54" (58cm x 137cm)		
9086 Adhesive Towel Drapes	2	39" x 30" (100cm x 76cm)		
9087 Adhesive Drape Sheet (M)	1	72" x 72" (183cm x 183cm)		
9088 Adhesive Drape Sheet (L)	1	98" x 59" (250cm x 150cm)		
9077 Back Table Cover	1	78" x 59" (200cm x 150cm)		

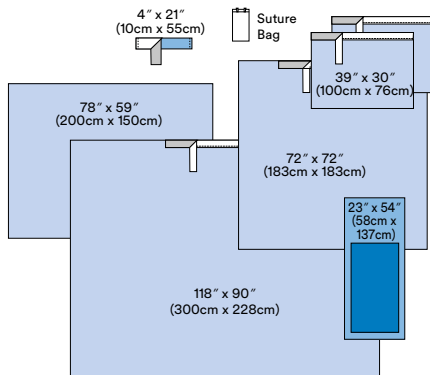

9000LA Basic Surgical Pack

Name	Quantity	Overall Size	Packs/Box	Boxes/Case
9000LA Basic Surgical Pack			5	2
Suture Bag	1			
9099 Operation Tape	1	4" x 21" (10cm x 55cm)		
9036 Mayo Stand Cover	1	23" x 54" (58cm x 137cm)		
9086 Adhesive Towel Drapes	2	39" x 30" (100cm x 76cm)		
9087 Adhesive Drape Sheet (M)	1	72" x 72" (183cm x 183cm)		
9090 Adhesive Drape Sheet (XL)	1	118" x 90" (300cm x 228cm)		
9077 Back Table Cover	1	78" x 59" (200cm x 150cm)		

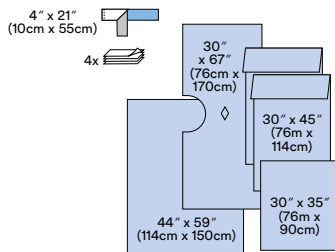

9003 Cystoscopy Pack

Name	Quantity	Overall Size	Packs/Box	Boxes/Case
9003 Cystoscopy Pack			10	2
9099 Operation Tape	1	4" x 21" (10cm x 55cm)		
Hand Towels	4	-		
9040 Leggings (pair)	1	30" x 45" (76cm x 114cm)		
9069 Drape Sheet	1	30" x 35" (76cm x 90cm)		
9023 Perineal Aperture Drape	1	30" x 67" (76cm x 170cm)		
9072 Back Table Cover	1	44" x 59" (114cm x 150cm)		

KEY

 Absorbent Prevention Fabric

 Standard Blue Fabric (fluid-repellent)

 Clear plastic film

 3M™ Ioban™ 2 Antimicrobial Incise Film

 3M™ Steri-Drape™ 2 Incise Film

 Adhesive area

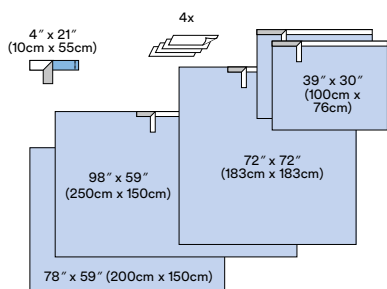

9010 Basic Surgical Pack without Mayo Stand Cover

Name	Quantity	Overall Size	Packs/Box	Boxes/Case
9010 Basic Surgical Pack without Mayo Stand Cover				
9099 Operation Tape	1	4" x 21" (10cm x 55cm)	7	2
Hand Towels	4	-		
9085 Adhesive Towel Drapes	2	39" x 33" (100cm x 85cm)		
9087 Adhesive Drape Sheet (M)	1	72" x 72" (183cm x 183cm)		
9088 Adhesive Drape Sheet (L)	1	98" x 59" (250cm x 150cm)		
9077 Back Table Cover	1	78" x 59" (200cm x 150cm)		

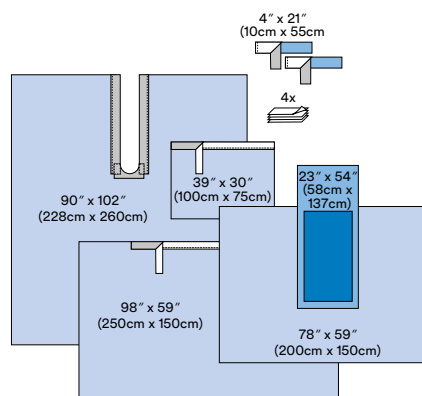

9018A Surgical Split Sheet Pack

Name	Quantity	Overall Size	Packs/Box	Boxes/Case
9018A Surgical Split Sheet Pack				
9099 Operation Tape	2	4" x 21" (10cm x 55cm)	6	2
9036 Mayo Stand Cover	1	23" x 54" (58cm x 137cm)		
9086 Adhesive Towel Drape	1	39" x 30" (100cm x 76cm)		
9045 Adhesive Split Sheet	1	90" x 102" (228cm x 260cm)		
9088 Adhesive Drape Sheet (L)	1	98" x 59" (250cm x 150cm)		
9077 Back Table Cover	1	78" x 59" (200cm x 150cm)		

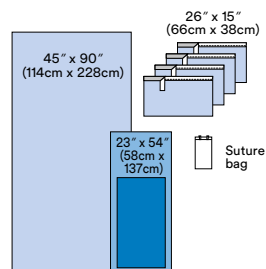

9020A Basic Set-Up Pack

Name	Quantity	Overall Size	Packs/Box	Boxes/Case
9020A Basic Set-Up Pack				
Suture Bag	1		20	2
9036 Mayo Stand Cover	1	23" x 54" (58cm x 137cm)		
Utility Drapes	4	26" x 15" (66cm x 38cm)		
Back Table Cover	1	45" x 90" (114cm x 228cm)		

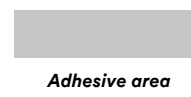

3M™ Steri-Drape™

GENERAL SURGERY DRAPES

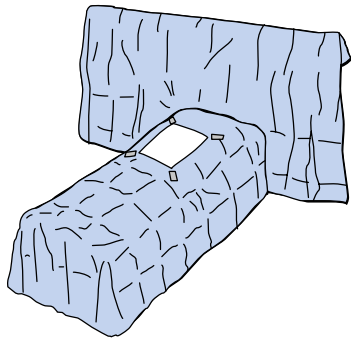

1031 Laparoscopic Drape/Supine Position

Overall Size	Drapes/Box	Boxes/Case
112" x 90" (285cm x 228cm)	10	2
<ul style="list-style-type: none"> • Adhesive aperture: 10" x 11" (27cm x 30cm) • 4 – Tube organizers (ref.1115) 		
1031NS (non-sterile) <i>Custom Packs Only</i>	30 ea/cs	

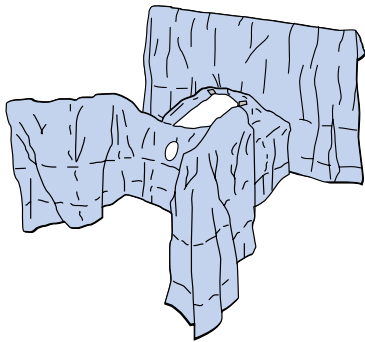

1032 Laparoscopic Drape/Lithotomy Position

Overall Size	Drapes/Box	Boxes/Case
95" x 90" (241cm x 228cm)	8	2
<ul style="list-style-type: none"> • Adhesive aperture: 11" x 12" (27cm x 30cm) • Peri/vag. aperture: 5" x 6" (12cm x 15.5cm) • Leggings: 46" (117cm) • 4 – Tube organizers (ref.1115) 		
1032NS (non-sterile) <i>Custom Packs Only</i>	20 ea/cs	

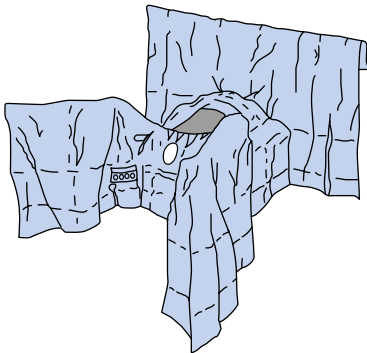

2065 Abdominoperineal Incise Drape

Overall Size	Drapes/Box	Boxes/Case
77" x 160" (195cm x 271cm)	8	2
<ul style="list-style-type: none"> • Steri-Drape 2 incise area: 16" x 17.5" (41cm x 45cm) • Peri/vag. aperture: 4.5" x 6" (12cm x 15.5cm) • Tube and cord organizers (ref.1115) 		
2065NS (non-sterile) <i>Custom Packs Only</i>	20 ea/cs	

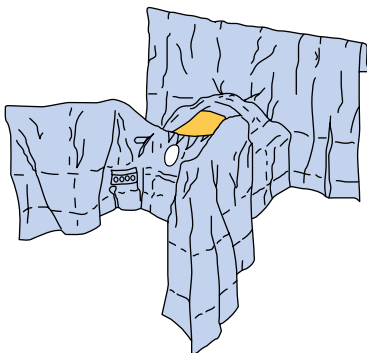

6665 Abdominal-Perineal Drape with loban 2 Incise Film – Lithotomy Position

Overall Size	Drapes/Box	Boxes/Case
78" x 107" (200cm x 274cm)	5	1
<ul style="list-style-type: none"> • loban 2 antimicrobial incise area: 13" x 17" (33cm x 45cm) • Peri/vag. aperture: 5" x 6" (12cm x 15.5cm) • Tube and cord organizers (ref.1115) 		

KEY

 Absorbent Prevention Fabric

 Standard Blue Fabric (fluid-repellent)

 Clear plastic film

 3M™ loban™ 2 Antimicrobial Incise Film

 3M™ Steri-Drape™ 2 Incise Film

 Adhesive area

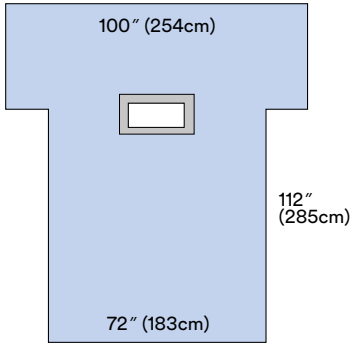

9062 Laparotomy Drape (Transverse)

Overall Size	Drapes/Box	Boxes/Case
72" x 112" (183cm x 285cm)	12	2
<ul style="list-style-type: none"> Aperture: 12" x 4" (30cm x 10cm) 		
9062NS (non-sterile) <i>Custom Packs Only</i>	30 ea/cs	

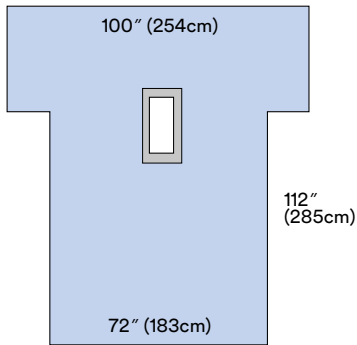

9063 Laparotomy Drape

Overall Size	Drapes/Box	Boxes/Case
100" x 112" (254cm x 285cm)	10	2
<ul style="list-style-type: none"> Aperture: 4" x 12" (10cm x 30cm) 		
9063NS (non-sterile) <i>Custom Packs Only</i>	30 ea/cs	

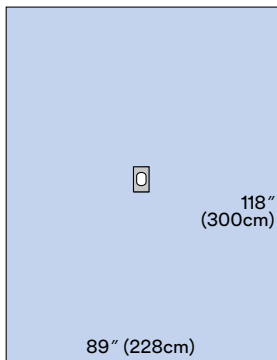

9050 Adhesive Aperture Drape

Overall Size	Drapes/Box	Boxes/Case
89" x 118" (228cm x 300cm)	10	2
<ul style="list-style-type: none"> Adhesive aperture: 5" x 6" (12cm x 16cm) 		
9050NS (non-sterile) <i>Custom Packs Only</i>	30 ea/cs	

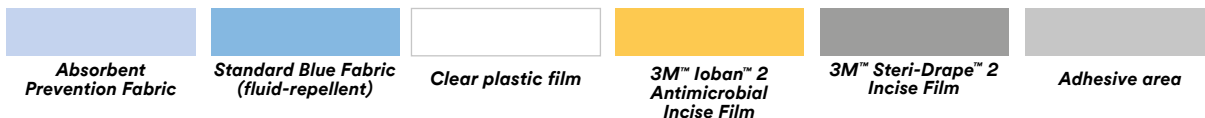

3M™ Steri-Drape™ GENERAL SURGERY DRAPES

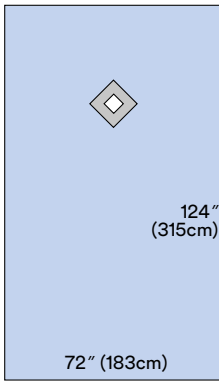

9051 Thyroid Drape

Overall Size	Drapes/Box	Boxes/Case
<ul style="list-style-type: none"> • Adhesive diamond aperture: 5" x 5" (12cm x 12cm) • Adhesive aperture: 5" x 6" (12cm x 16cm) 	10	2
9051NS (non-sterile) <i>Custom Packs Only</i>	34 ea/cs	

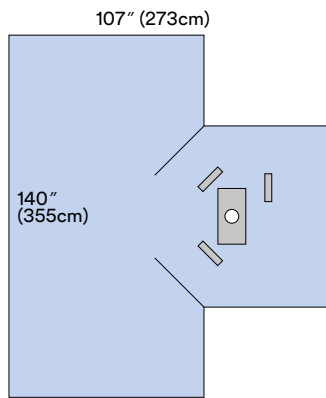

9052 Hand Drape

Overall Size	Drapes/Box	Boxes/Case
140" x 115" (355cm x 293cm)	9	2
<ul style="list-style-type: none"> • Elastic circle aperture: 1" (3cm) • 3 – Tube and cord organizers 		
9052NS (non-sterile) <i>Custom Packs Only</i>	20 ea/cs	

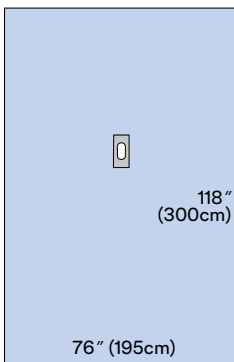

9054 Hand and Foot Drape

Overall Size	Drapes/Box	Boxes/Case
76" x 118" (195cm x 300cm)	15	2
<ul style="list-style-type: none"> • Elastic aperture: 1" (3cm) 		
9054NS (non-sterile) <i>Custom Packs Only</i>	30 ea/cs	

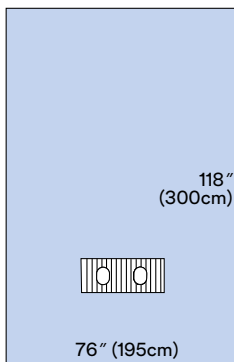

9056 Bilateral Foot Drape

Overall Size	Drapes/Box	Boxes/Case
76" x 118" (195cm x 300cm)	13	2
<ul style="list-style-type: none"> • Elastic apertures: 2" (4cm) 		
9056NS (non-sterile) <i>Custom Packs Only</i>	28 ea/cs	

KEY

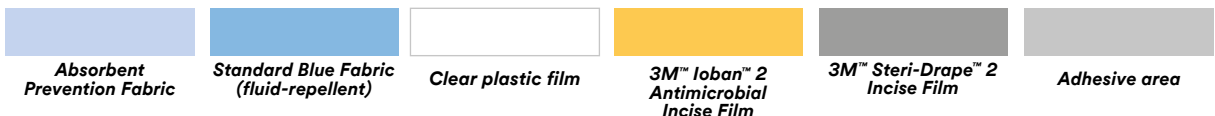

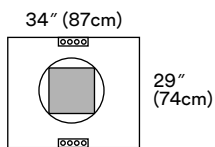

2057 Incise Pouch

Overall Size	Drapes/Box	Boxes/Case
34" x 29" (87cm x 74cm)	10	4
<ul style="list-style-type: none"> • Incise area: 12" x 12" (30cm x 30cm) • 360-degree fluid collection pouch • Tube and cord organizers 		
2057NS (non-sterile) <i>Custom Packs Only</i>	100 ea/cs	

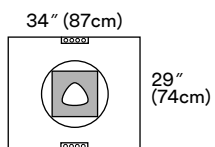

2058 Aperture Pouch Drape

Overall Size	Drapes/Box	Boxes/Case
34" x 29" (87cm x 74cm)	10	4
<ul style="list-style-type: none"> • Aperture incise area: 12" x 12" (30cm x 30cm) • 360-degree fluid collection pouch • Tube and cord organizers 		
2058NS (non-sterile) <i>Custom Packs Only</i>	100 ea/cs	

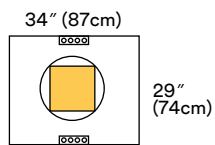

6657 Pouch with Ioban 2 Incise Film

Overall Size	Drapes/Box	Boxes/Case
34" x 29" (87cm x 74cm)	10	4
<ul style="list-style-type: none"> • Ioban 2 antimicrobial incise area: 11" x 11" (30cm x 30cm) • 360-degree fluid collection pouch • Tube and cord organizers 		

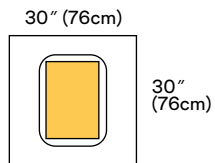

6658 Pouch with Ioban 2 Incise Film, Large

Overall Size	Drapes/Box	Boxes/Case
30" x 30" (76cm x 76cm)	5	4
<ul style="list-style-type: none"> • Ioban 2 antimicrobial incise area: 13" x 17" (33cm x 43cm) • 360-degree fluid collection pouch 		

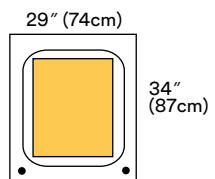

6659 Pouch with Ioban 2 Incise Film, Extra Large

Overall Size	Drapes/Box	Boxes/Case
29" x 34" (74cm x 87cm)	5	4
<ul style="list-style-type: none"> • Ioban 2 antimicrobial incise area: 16" x 20" (42cm x 52cm) • 360-degree fluid collection pouch • 2 - Exit ports 		

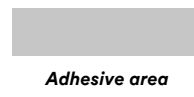

3M™ Steri-Drape™ GENERAL SURGERY DRAPES

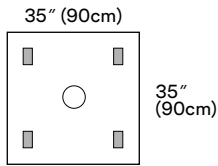

1073 Wound Edge Protector

Overall Size	Drapes/Box	Boxes/Case
35" x 35" (90cm x 90cm)	10	4
<ul style="list-style-type: none"> • Ring diameter: 5" (12cm) • 4 – Adhesive patches 		

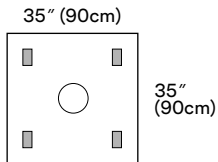

1074 Wound Edge Protector

Overall Size	Drapes/Box	Boxes/Case
35" x 35" (90cm x 90cm)	10	4
<ul style="list-style-type: none"> • Ring diameter: 7" (17cm) • 4 – Adhesive patches 		

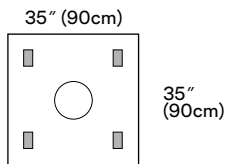

1075 Wound Edge Protector

Overall Size	Drapes/Box	Boxes/Case
35" x 35" (90cm x 90cm)	10	4
<ul style="list-style-type: none"> • Ring diameter: 9" (22cm) • 4 – Adhesive patches 		

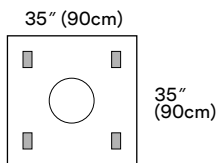

1076 Wound Edge Protector

Overall Size	Drapes/Box	Boxes/Case
35" x 35" (90cm x 90cm)	10	4
<ul style="list-style-type: none"> • Ring diameter: 10" (27cm) • 4 – Adhesive patches 		

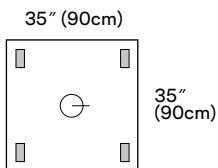

1077 Wound Edge Protector

Overall Size	Drapes/Box	Boxes/Case
35" x 35" (90cm x 90cm)	10	4
<ul style="list-style-type: none"> • Ring diameter: 3" (8cm) • 4 – Adhesive patches 		

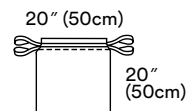

1003 Isolation Bag

Overall Size	Drapes/Box	Boxes/Case
20" x 20" (50cm x 50cm)	10	4
<ul style="list-style-type: none"> • Drawstring closure 		
1003NS (non-sterile) <i>Custom Packs Only</i>	200 ea/cs	

KEY

 Absorbent Prevention Fabric

 Standard Blue Fabric (fluid-repellent)

 Clear plastic film

 3M™ Ioban™ 2 Antimicrobial Incise Film

 3M™ Steri-Drape™ 2 Incise Film

 Adhesive area

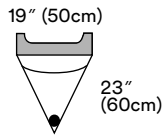

1016 Irrigation Pouch

Overall Size	Drapes/Box	Boxes/Case
19" x 23" (50cm x 60cm)	10	4
<ul style="list-style-type: none"> • Adhesive strip • 1 – Exit port • Screen 		
1016NS (non-sterile) <i>Custom Packs Only</i>	200 ea/cs	

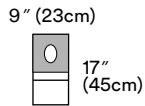

1072 Aperture Pouch Drape

Overall Size	Packs/Box	Boxes/Case
9" x 17" (23cm x 45cm)	10	4
<ul style="list-style-type: none"> • Adhesive area: 9" x 10" (23cm x 25cm) • Oval aperture: 3.5" x 4.25" (9cm x 11cm) • Fluid collection pouch 		
1072NS (non-sterile) <i>Custom Packs Only</i>	200 ea/cs	

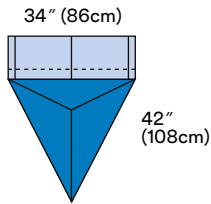

1084 Under Buttocks Drape with Pouch

Overall Size	Drapes/Box	Boxes/Case
34" x 42" (86cm x 108cm)	30	4
<ul style="list-style-type: none"> • Cuff size: 10" (25cm) • Fluid collection pouch 		
1084NS (non-sterile) <i>Custom Packs Only</i>	140 ea/cs	

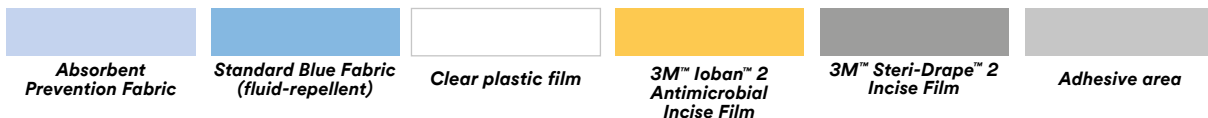

3M™ Steri-Drape™ UROLOGY DRAPES

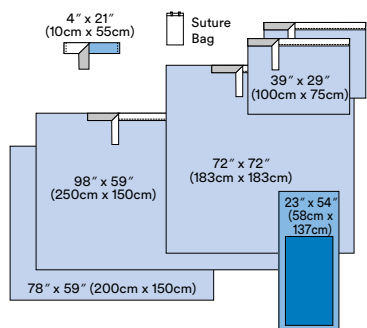

9000A Basic Surgical Pack

Name	Quantity	Overall Size	Packs/Box	Boxes/Case
9000A Basic Surgical Pack				
Suture Bag	1		7	2
9099 Operation Tape	1	4" x 21" (10cm x 55cm)		
9036 Mayo Stand Cover	1	23" x 54" (58cm x 137cm)		
9086 Adhesive Towel Drapes	2	39" x 30" (100cm x 76cm)		
9087 Adhesive Drape Sheet (M)	1	72" x 72" (183cm x 183cm)		
9088 Adhesive Drape Sheet (L)	1	98" x 59" (250cm x 150cm)		
9077 Back Table Cover	1	78" x 59" (200cm x 150cm)		

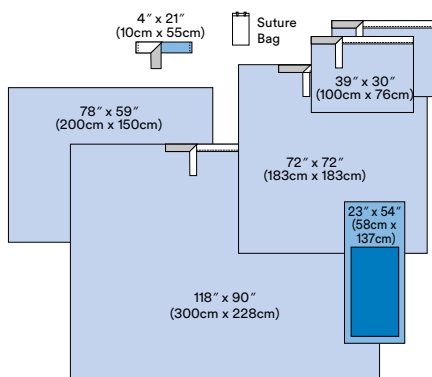

9000LA Basic Surgical Pack

Name	Quantity	Overall Size	Packs/Box	Boxes/Case
9000LA Basic Surgical Pack				
Suture Bag	1		5	2
9099 Operation Tape	1	4" x 21" (10cm x 55cm)		
9036 Mayo Stand Cover	1	23" x 54" (58cm x 137cm)		
9086 Adhesive Towel Drapes	2	39" x 30" (100cm x 76cm)		
9087 Adhesive Drape Sheet (M)	1	72" x 72" (183cm x 183cm)		
9090 Adhesive Drape Sheet (XL)	1	118" x 90" (300cm x 228cm)		
9077 Back Table Cover	1	78" x 59" (200cm x 150cm)		

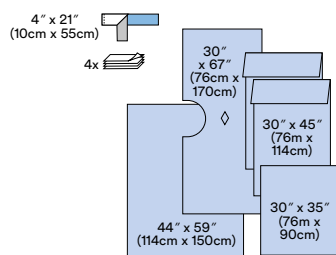

9003 Cystoscopy Pack

Name	Quantity	Overall Size	Packs/Box	Boxes/Case
9003 Cystoscopy Pack				
Suture Bag	1		10	2
9099 Operation Tape	1	4" x 21" (10cm x 55cm)		
Hand Towels	4	-		
9040 Leggings (pair)	1	30" x 45" (76cm x 114cm)		
9069 Drape Sheet	1	30" x 35" (76cm x 90cm)		
9023 Perineal Aperture Drape	1	30" x 67" (76cm x 170cm)		
9072 Back Table Cover	1	44" x 59" (114cm x 150cm)		

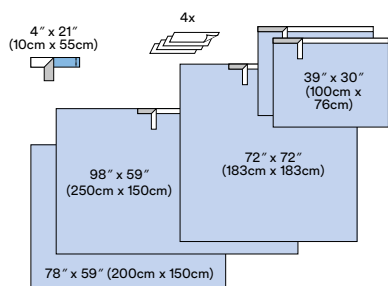

9010 Basic Surgical Pack without Mayo Stand Cover

Name	Quantity	Overall Size	Packs/Box	Boxes/Case
9010 Basic Surgical Pack without Mayo Stand Cover				
Suture Bag	1		7	2
9099 Operation Tape	1	4" x 21" (10cm x 55cm)		
Hand Towels	4	-		
9085 Adhesive Towel Drapes	2	39" x 33" (100cm x 85cm)		
9087 Adhesive Drape Sheet (M)	1	72" x 72" (183cm x 183cm)		
9088 Adhesive Drape Sheet (L)	1	98" x 59" (250cm x 150cm)		
9077 Back Table Cover	1	78" x 59" (200cm x 150cm)		

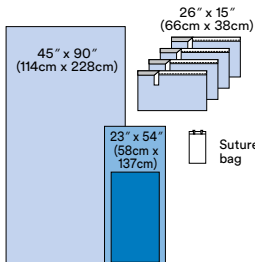

9020A Basic Set-Up Pack

Name	Quantity	Overall Size	Packs/Box	Boxes/Case
9020A Basic Set-Up Pack				
Suture Bag	1		20	2
9036 Mayo Stand Cover	1	23" x 54" (58cm x 137cm)		
Utility Drapes	4	26" x 15" (66cm x 38cm)		
Back Table Cover	1	45" x 90" (114cm x 228cm)		



Absorbent Prevention Fabric	Standard Blue Fabric (fluid-repellent)	Clear plastic film	3M™ Ioban™ 2 Antimicrobial Incise Film	3M™ Steri-Drape™ 2 Incise Film	Adhesive area

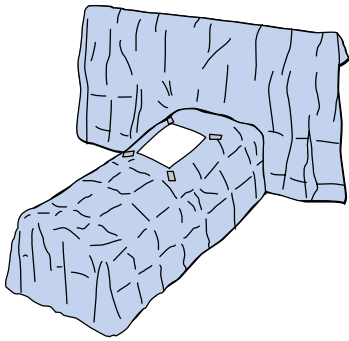

1031 Laparoscopic Drape/Supine Position

Overall Size	Drapes/Box	Boxes/Case
112" x 90" (285cm x 228cm)	10	2
<ul style="list-style-type: none"> • Adhesive aperture: 10" x 11" (27cm x 30cm) • 4 – Tube organizers (ref.1115) 		
1031NS (non-sterile) <i>Custom Packs Only</i>	30 ea/cs	

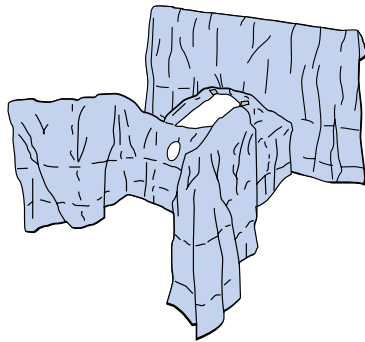

1032 Laparoscopic Drape/Lithotomy Position

Overall Size	Drapes/Box	Boxes/Case
95" x 90" (241cm x 228cm)	8	2
<ul style="list-style-type: none"> • Adhesive aperture: 11" x 12" (27cm x 30cm) • Peri/vag. aperture: 5" x 6" (12cm x 15.5cm) • Leggings: 46" (117cm) • 4 – Tube organizers (ref.1115) 		
1032NS (non-sterile) <i>Custom Packs Only</i>	20 ea/cs	

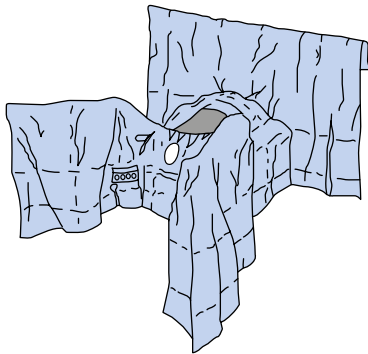

2065 Abdominoperineal Incise Drape

Overall Size	Drapes/Box	Boxes/Case
77" x 160" (195cm x 271cm)	8	2
<ul style="list-style-type: none"> • Steri-Drape 2 incise area: 16" x 18" (41cm x 45cm) • Peri/vag. aperture: 5" x 6" (12cm x 15.5cm) • Tube and cord organizers (ref.1115) 		
2065NS (non-sterile) <i>Custom Packs Only</i>	20 ea/cs	

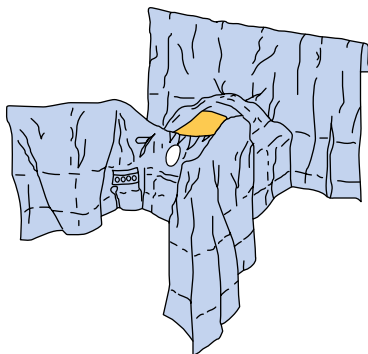

6665 Abdominal-Perineal Drape with Ioban 2 Incise Film – Lithotomy Position

Overall Size	Drapes/Box	Boxes/Case
78" x 107" (200cm x 274cm)	5	1
<ul style="list-style-type: none"> • Ioban 2 antimicrobial incise area: 13" x 17" (33cm x 45cm) • Peri/vag. aperture: 5" x 6" (12cm x 16cm) • Tube and cord organizers (ref.1115) 		



3M™ Steri-Drape™

UROLOGY DRAPES

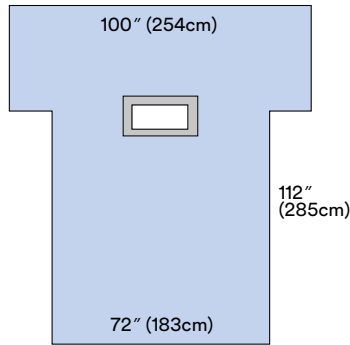

9062 Laparotomy Drape (Transverse)

Overall Size	Drapes/Box	Boxes/Case
72" x 112" (183cm x 285cm)	12	2

- Aperture: 12" x 4" (30cm x 10cm)

9062NS (non-sterile) Custom Packs Only

30 ea/cs

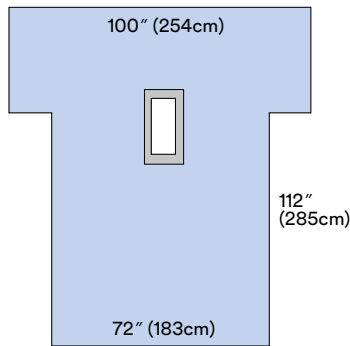

9063 Laparotomy Drape

Overall Size	Drapes/Box	Boxes/Case
100" x 112" (254cm x 285cm)	10	2

- Aperture: 4" x 12" (10cm x 30cm)

9063NS (non-sterile) Custom Packs Only

30 ea/cs

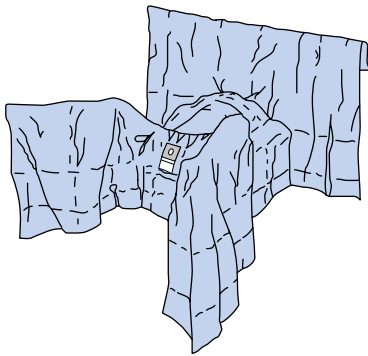

1080 Gynaecology Drape

Overall Size	Drapes/Box	Boxes/Case
77" x 70" (195cm x 179cm)	14	2

- Peri/vag. aperture: 4" x 5" (9cm x 12cm)
- Tube and cord organizers (ref.1115)
- Fluid collection pouch (ref.)

1080NS (non-sterile) Custom Packs Only

30 ea/cs

Leggings 46" (117cm)

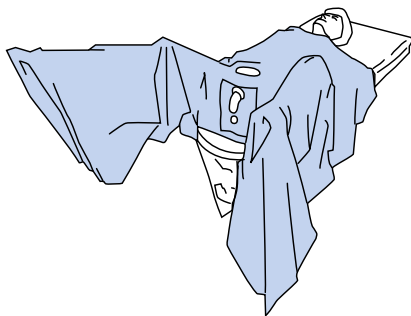

1081 TUR/Urological Drape

Overall Size	Drapes/Box	Boxes/Case
Length: 64" (164cm)	14	2
Width at arm extensions: 60" (152cm)		

- Abdominal adhesive aperture: 2" (6cm)
- Elastic aperture
- Non-latex finger cot
- Large integrated fluid collection pouch with filter and exit ports

1081NS (non-sterile) Custom Packs Only

30 ea/cs

KEY

Absorbent
Prevention Fabric

Standard Blue Fabric
(fluid-repellent)

Clear plastic film

3M™ Ioban™ 2
Antimicrobial
Incise Film

3M™ Steri-Drape™ 2
Incise Film

Adhesive area

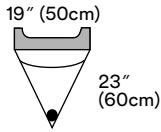

1016 Irrigation Pouch

Overall Size	Drapes/Box	Boxes/Case
19" x 23" (50cm x 60cm)	10	4
<ul style="list-style-type: none"> • Adhesive strip • 1 – Exit port • Screen 		
1016NS (non-sterile) <i>Custom Packs Only</i>	200 ea/cs	

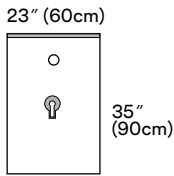

1071 Urological Drape

Overall Size	Packs/Box	Boxes/Case
23" x 35" (60cm x 90cm)	10	4
<ul style="list-style-type: none"> • Aperture area: 2" (5cm) • Non-latex finger cot with adhesive • Adhesive strip 		
1071NS (non-sterile) <i>Custom Packs Only</i>	200 ea/cs	

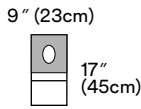

1072 Aperture Pouch Drape

Overall Size	Packs/Box	Boxes/Case
9" x 17" (23cm x 45cm)	10	4
<ul style="list-style-type: none"> • Adhesive area: 9" x 10" (23cm x 25cm) • Oval aperture: 3.5" x 4.25" (9cm x 11cm) • Fluid collection pouch 		
1072NS (non-sterile) <i>Custom Packs Only</i>	200 ea/cs	

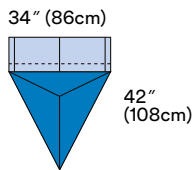

1084 Under Buttocks Drape with Pouch

Overall Size	Drapes/Box	Boxes/Case
34" x 42" (86cm x 108cm)	30	4
<ul style="list-style-type: none"> • Cuff size: 10" (25cm) • Fluid collection pouch 		
1084NS (non-sterile) <i>Custom Packs Only</i>	140 ea/cs	

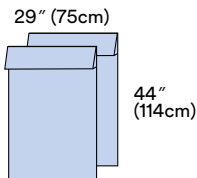

9040 Leggings (2)

Overall Size	Drapes/Box	Boxes/Case
29" x 44" (75cm x 114cm)	10	4
9040NS (non-sterile) <i>Custom Packs Only</i>	116 ea/cs	

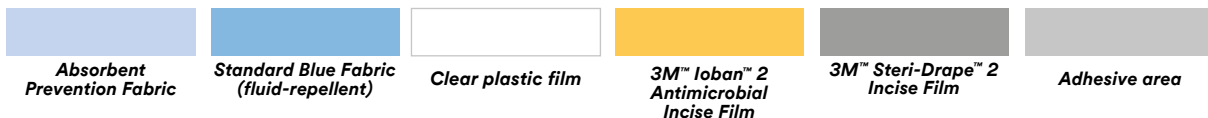

3M™ Steri-Drape™ NEUROLOGY DRAPES

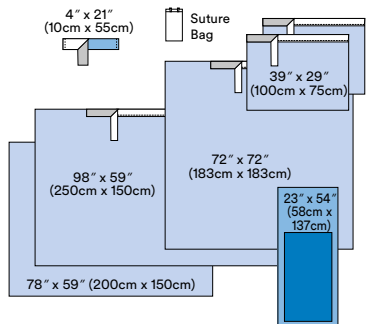

9000A Basic Surgical Pack

Name	Quantity	Overall Size	Packs/Box	Boxes/Case
9000A Basic Surgical Pack				
Suture Bag	1		7	2
9099 Operation Tape	1	4" x 21" (10cm x 55cm)		
9036 Mayo Stand Cover	1	23" x 54" (58cm x 137cm)		
9086 Adhesive Towel Drapes	2	39" x 30" (100cm x 76cm)		
9087 Adhesive Drape Sheet (M)	1	72" x 72" (183cm x 183cm)		
9088 Adhesive Drape Sheet (L)	1	98" x 59" (250cm x 150cm)		
9077 Back Table Cover	1	78" x 59" (200cm x 150cm)		

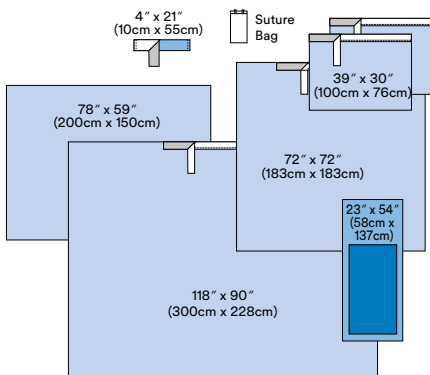

9000LA Basic Surgical Pack

Name	Quantity	Overall Size	Packs/Box	Boxes/Case
9000LA Basic Surgical Pack				
Suture Bag	1		5	2
9099 Operation Tape	1	4" x 21" (10cm x 55cm)		
9036 Mayo Stand Cover	1	23" x 54" (58cm x 137cm)		
9086 Adhesive Towel Drapes	2	39" x 30" (100cm x 76cm)		
9087 Adhesive Drape Sheet (M)	1	72" x 72" (183cm x 183cm)		
9090 Adhesive Drape Sheet (XL)	1	118" x 90" (300cm x 228cm)		
9077 Back Table Cover	1	78" x 59" (200cm x 150cm)		

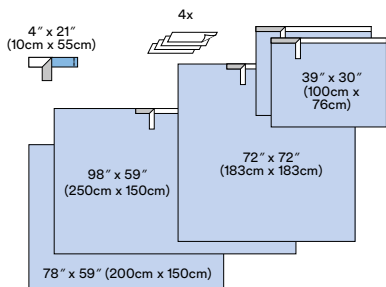

9010 Basic Surgical Pack without Mayo Stand Cover

Name	Quantity	Overall Size	Packs/Box	Boxes/Case
9010 Basic Surgical Pack without Mayo Stand Cover				
9099 Operation Tape	1	4" x 21" (10cm x 55cm)	7	2
Hand Towels	4	-		
9085 Adhesive Towel Drapes	2	39" x 33" (100cm x 85cm)		
9087 Adhesive Drape Sheet (M)	1	72" x 72" (183cm x 183cm)		
9088 Adhesive Drape Sheet (L)	1	98" x 59" (250cm x 150cm)		
9077 Back Table Cover	1	78" x 59" (200cm x 150cm)		

KEY

 Absorbent Prevention Fabric

 Standard Blue Fabric (fluid-repellent)

 Clear plastic film

 3M™ Ioban™ 2 Antimicrobial Incise Film

 3M™ Steri-Drape™ 2 Incise Film

 Adhesive area

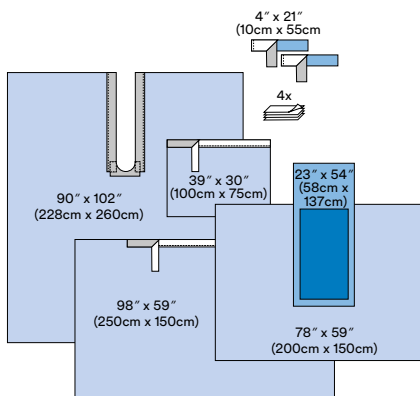

9018A Surgical Split Sheet Pack

Name	Quantity	Overall Size	Packs/Box	Boxes/Case
9018A Surgical Split Sheet Pack				
9099 Operation Tape	2	4" x 21" (10cm x 55cm)	6	2
9036 Mayo Stand Cover	1	23" x 54" (58cm x 137cm)		
9086 Adhesive Towel Drape	1	39" x 30" (100cm x 76cm)		
9045 Adhesive Split Sheet	1	90" x 102" (228cm x 260cm)		
9088 Adhesive Drape Sheet (L)	1	98" x 59" (250cm x 150cm)		
9077 Back Table Cover	1	78" x 59" (200cm x 150cm)		

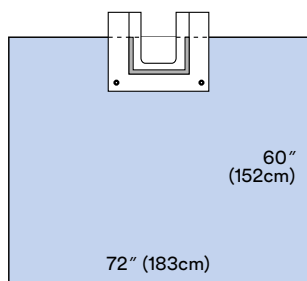

9047 Neuro Split Sheet with Pouch

Overall Size	Drapes/Box	Boxes/Case
72" x 60" (183cm x 152cm)	15	2
<ul style="list-style-type: none"> • Adhesive split: 6" x 15" (16cm x 40cm) • Fluid collection pouch (ref. 1067) • 2 – Exit ports 		
9047NS (non-sterile) <i>Custom Packs Only</i>	32 ea/cs	

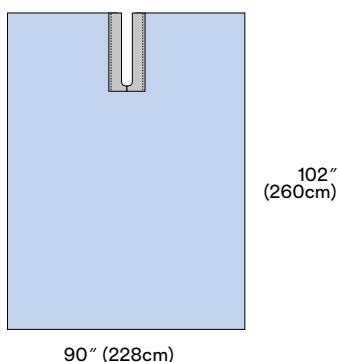

9048 Adhesive Split Sheet

Overall Size	Drapes/Box	Boxes/Case
90" x 102" (228cm x 260cm)	15	2
<ul style="list-style-type: none"> • Adhesive split: 7" x 15" (20cm x 40cm) 		
9048NS (non-sterile) <i>Custom Packs Only</i>	32 ea/cs	

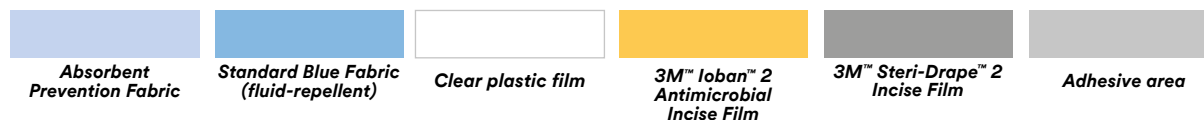

3M™ Steri-Drape™ NEUROLOGY DRAPES

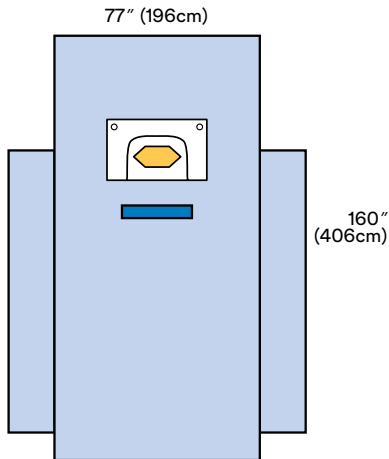

6687 Craniotomy Drape with loban 2 Incise Pouch

Overall Size	Drapes/Box	Boxes/Case
77" x 160" (196cm x 406cm)	10	1

- Incise area: 15" x 8" (36.8cm x 21.4cm)
- Large rectangular fluid collection pouch
- Reinforced plastic strip with a wide adhesive secular

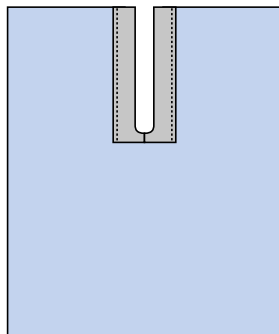

Adhesive Split Sheets

	Overall Size	Split Size	Drapes/Box	Boxes/Case
9043	60" x 72" (152cm x 183cm)	2.5" x 25" (7x70cm)	30	2
9044	60" x 98" (152cm x 250cm)	2.5" x 25" (7x70cm)	25	2
9045	90" x 102" (228cm x 260cm)	8" x 39" (20cm x 100cm)	15	2
9043NS (non-sterile) <i>Custom Packs Only</i>			68 ea/cs	
9044NS (non-sterile) <i>Custom Packs Only</i>			58 ea/cs	
9045NS (non-sterile) <i>Custom Packs Only</i>			30 ea/cs	

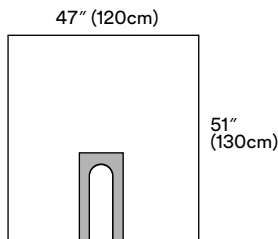

1015 U-drape

Overall Size	Drapes/Box	Boxes/Case
47" x 51" (120m x 130cm)	10	4

- Adhesive split: 7" x 18" (16.5cm x 46cm)

1015NSD (non-sterile)	100 ea/cs
1015NS (non-sterile) <i>Custom Packs Only</i>	200 ea/cs

KEY

Absorbent Prevention Fabric

Standard Blue Fabric (fluid-repellent)

Clear plastic film

3M™ Ioban™ 2 Antimicrobial Incise Film

3M™ Steri-Drape™ 2 Incise Film

Adhesive area

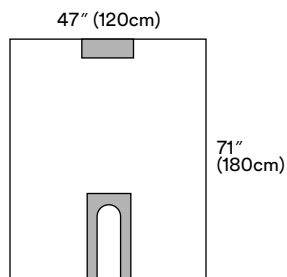

1019 Long U-drape

Overall Size	Drapes/Box	Boxes/Case
47" x 71" (120cm x 180cm)	10	4
<ul style="list-style-type: none"> • Adhesive split: 7" x 18" (16.5cm x 46cm) • Adhesive patch 		
1019NS (non-sterile) <i>Custom Packs Only</i>	200 ea/cs	

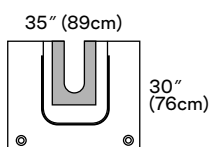

1067 U-pouch

Overall Size	Drapes/Box	Boxes/Case
35" x 30" (89cm x 76cm)	5	4
<ul style="list-style-type: none"> • Adhesive split: 6" x 15" (16cm x 40cm) • Fluid collection pouch • 2 – Exit ports 		
1067NS (non-sterile) <i>Custom Packs Only</i>	50 ea/cs	

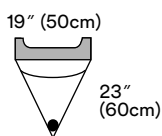

1016 Irrigation Pouch

Overall Size	Drapes/Box	Boxes/Case
19" x 23" (50cm x 60cm)	10	4
<ul style="list-style-type: none"> • Adhesive strip • 1 – Exit port • Screen 		
1016NS (non-sterile) <i>Custom Packs Only</i>	200 ea/cs	



SURGICAL SHEETS AND ACCESSORIES

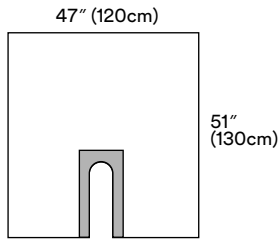

1015 U-drape

Overall Size	Drapes/Box	Boxes/Case
47" x 51" (120cm x 130cm)	10	4
<ul style="list-style-type: none"> • Adhesive split: 6½" x 18" (16.5cm x 46cm) 		
1015NSD (non-sterile)	100 ea/cs	
1015NS (non-sterile) <i>Custom Packs Only</i>	200 ea/cs	

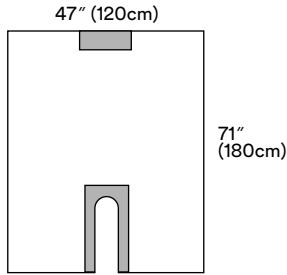

1019 Long U-drape

Overall Size	Drapes/Box	Boxes/Case
47" x 71" (120cm x 180cm)	10	4
<ul style="list-style-type: none"> • Adhesive split: 6½" x 18" (16.5cm x 46cm) • Adhesive patch 		
1019NS (non-sterile) <i>Custom Packs Only</i>	200 ea/cs	

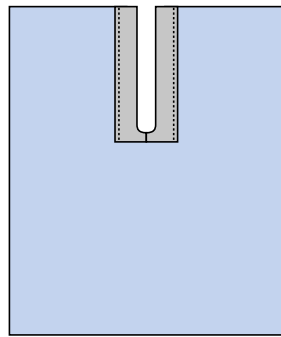

Adhesive Split Sheets

	Overall Size	Split Size	Drapes/Box	Boxes/Case
9043	60" x 72" (152cm x 183cm)	2.5" x 25" (7x70cm)	30	2
9044	60" x 98" (152cm x 250cm)	2.5" x 25" (7x70cm)	25	2
9045	90" x 102" (228cm x 260cm)	8" x 39" (20cm x 100cm)	15	2
9043NS (non-sterile) <i>Custom Packs Only</i>			68 ea/cs	
9044NS (non-sterile) <i>Custom Packs Only</i>			58 ea/cs	
9045NS (non-sterile) <i>Custom Packs Only</i>			30 ea/cs	

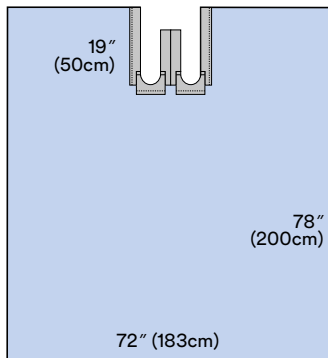

9046 Bilateral Adhesive Split Sheet

Overall Size	Drapes/Box	Boxes/Case
72" x 78" (183cm x 200cm)	15	2
<ul style="list-style-type: none"> • Double adhesive split: 5⅞" x 19" (15cm x 50cm) 		
9046NS (non-sterile) <i>Custom Packs Only</i>	30 ea/cs	

KEY

 Absorbent Prevention Fabric

 Standard Blue Fabric (fluid-repellent)

 Clear plastic film

 3M™ Ioban™ 2 Antimicrobial Incise Film

 3M™ Steri-Drape™ 2 Incise Film

 Adhesive area

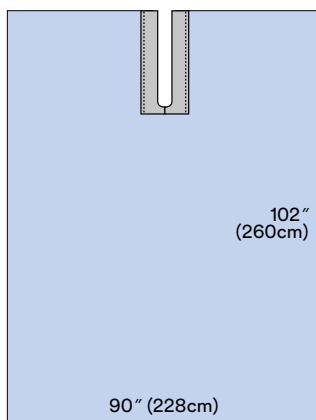

9048 Adhesive Split Sheet

Overall Size	Drapes/Box	Boxes/Case
90" x 102" (228cm x 260cm)	15	2
<ul style="list-style-type: none"> Adhesive split: 7" x 15" (20cm x 40cm) 		
9048NS (non-sterile) <i>Custom Packs Only</i>	32 ea/cs	

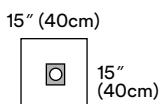

1020 Small Drape with Adhesive Aperture

Overall Size	Drapes/Box	Boxes/Case
15" x 15" (40cm x 40cm)	10	4
<ul style="list-style-type: none"> Adhesive area: 4" x 5" (10cm x 12.5cm) Circle aperture: 2³/₈" (6.3cm) 		
1020NS (non-sterile) <i>Custom Packs Only</i>	200 ea/cs	

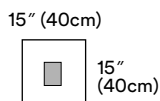

1021 Small Drape with Incise Film

Overall Size	Drapes/Box	Boxes/Case
15" x 15" (40cm x 40cm)	10	4
<ul style="list-style-type: none"> Incise area: 4" x 5" (10cm x 12.5cm) 		
1021NS (non-sterile) <i>Custom Packs Only</i>	200 ea/cs	

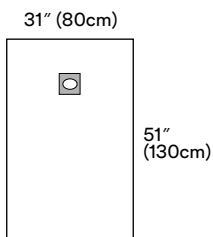

1030 Medium Drape with Adhesive Aperture

Overall Size	Drapes/Box	Boxes/Case
31" x 51" (80cm x 130cm)	10	4
<ul style="list-style-type: none"> Adhesive area: 3⁷/₈" x 4⁷/₈" (10cm x 12.5cm) Oval aperture: 2" x 2⁷/₈" (5.2cm x 7.6cm) 		
1030NS (non-sterile) <i>Custom Packs Only</i>	200 ea/cs	

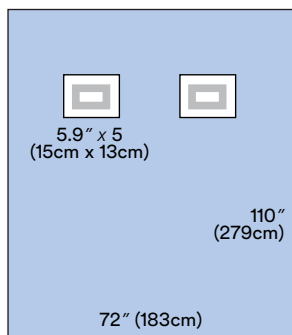

1135 PICC Drape with Adhesive Aperture

Overall Size	Drapes/Box	Boxes/Case
72" x 110" (183cm x 279cm)	15	2
<ul style="list-style-type: none"> Adhesive area: 5.9" x 5" (15cm x 13cm) Film window with adhesive Breakaway seams for left and right access sites 		



Absorbent
Prevention Fabric



Standard Blue Fabric
(fluid-repellent)



Clear plastic film



3M™ Ioban™ 2
Antimicrobial
Incise Film



3M™ Steri-Drape™ 2
Incise Film



Adhesive area

KEY

3M™ Steri-Drape™ SURGICAL SHEETS AND ACCESSORIES

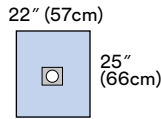

1092 Small Drape with Adhesive Aperture

Overall Size	Drapes/Box	Boxes/Case
22" x 25" (57cm x 66cm)	25	4
Adhesive area: 3 ⁷ / ₈ " x 3 ⁷ / ₈ " (10cm x 10cm)		
Circle aperture: 2.25" (6cm)		
1092NS (non-sterile) <i>Custom Packs Only</i>	500 ea/cs	

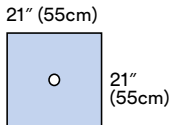

9026 Aperture Drape

Overall Size	Drapes/Box	Boxes/Case
21" x 21" (55cm x 55cm)	100	4
• Aperture: 2" x 3" (6cm x 8cm)		
9026NS (non-sterile) <i>Custom Packs Only</i>	700 ea/cs	

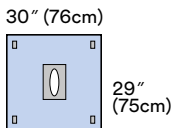

9029 Adhesive Aperture Drape

Overall Size	Drapes/Box	Boxes/Case
30" x 29" (76cm x 75cm)	40	4
• Adhesive aperture: 6" x 2" (15cm x 6cm)		
9029NS (non-sterile) <i>Custom Packs Only</i>	300 ea/cs	

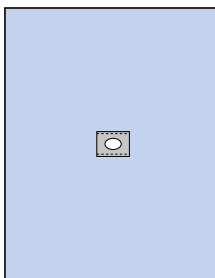

Adhesive Aperture Drape

	Overall Size	Drapes/Box	Boxes/Case
<i>Centered Aperture</i>			
9030	47" x 60" (120cm x 152cm)	20	4
<i>Off-Centered Aperture</i>			
9031	59" x 72" (150cm x 183cm)	25	2
• Adhesive aperture: 2" x 3" (6cm x 8cm)			
9030NS (non-sterile) <i>Custom Packs Only</i>		115 ea/cs	
9031NS (non-sterile) <i>Custom Packs Only</i>		80 ea/cs	

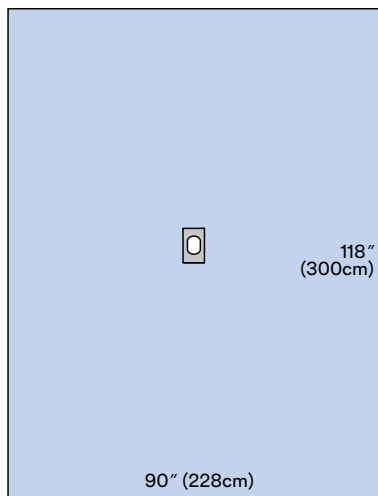

9050 Adhesive Aperture Drape

Overall Size	Drapes/Box	Boxes/Case
89" x 118" (228cm x 300cm)	10	2
• Adhesive aperture: 5" x 6" (12cm x 16cm)		
9050NS (non-sterile) <i>Custom Packs Only</i>	30 ea/cs	

KEY

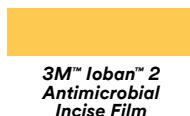

25 yds (22m)

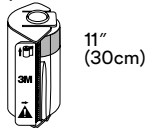
**1000Disp Roll Prep Drape**

Roll Size	Rolls/Case	Dispenser/Case
25 yds. x 11" (22m x 30cm)	1	1

- Adhesive strip
- Non-sterile

25 yds (22m)

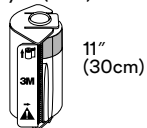
**1000NSR Roll Prep Drape**

Roll Size	Rolls/Case	Dispenser/Case
25 yds. x 11" (22m x 30cm)	8	1

- Adhesive strip
- Non-sterile

17" (45cm)

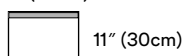
**1000 Small Towel Drape**

Overall Size	Drapes/Box	Boxes/Case
17" x 11" (45cm x 30cm)	10	4

- Adhesive strip

1000NSD (non-sterile)	100	1
------------------------------	-----	---

1000NS (non-sterile) <i>Custom Packs Only</i>	200 ea/cs	
--	-----------	--

17" (45cm)

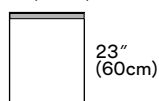
**1010 Large Towel Drape**

Overall Size	Drapes/Box	Boxes/Case
17" x 23" (45cm x 60cm)	10	4

- Adhesive strip

91010SD (non-sterile)	100	1
------------------------------	-----	---

1010NS (non-sterile) <i>Custom Packs Only</i>	300 ea/cs	
--	-----------	--

29" (75cm)

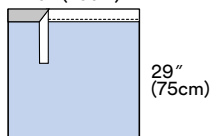
**9084 Adhesive Towel Drape**

Overall Size	Drapes/Box	Boxes/Case
29" x 29" (75cm x 75cm)	40	4

9084NS (non-sterile) <i>Custom Packs Only</i>	275 ea/cs	
--	-----------	--

39" (100cm)

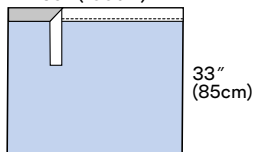
**9085 Adhesive Towel Drape**

Overall Size	Drapes/Box	Boxes/Case
39" x 33" (100cm x 85cm)	30	4

9085NS (non-sterile) <i>Custom Packs Only</i>	160 ea/cs	
--	-----------	--

Absorbent
Prevention FabricStandard Blue Fabric
(fluid-repellent)

Clear plastic film

3M™ Ioban™ 2
Antimicrobial
Incise Film3M™ Steri-Drape™ 2
Incise Film

Adhesive area

KEY

3M™ Steri-Drape™ SURGICAL SHEETS AND ACCESSORIES

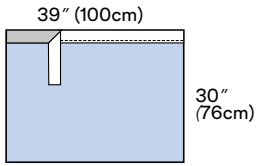

9086 Adhesive Towel Drape

Overall Size	Drapes/Box	Boxes/Case
39" x 30" (100cm x 76cm)	40	4
9086NS (non-sterile) <i>Custom Packs Only</i>	180 ea/cs	

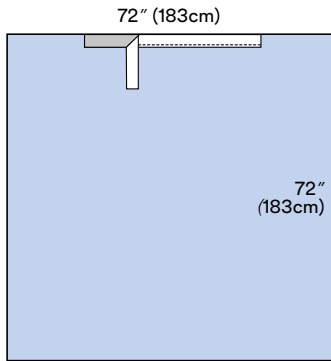

9087 Adhesive Drape Sheets

Overall Size	Drapes/Box	Boxes/Case
72" x 72" (183cm x 183cm)	25	2
9087NS (non-sterile) <i>Custom Packs Only</i>	50 ea/cs	

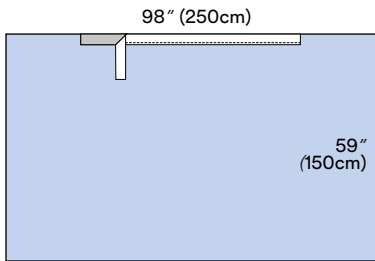

9088 Adhesive Drape Sheets

Overall Size	Drapes/Box	Boxes/Case
98" x 59" (250cm x 150cm)	25	2
9088NS (non-sterile) <i>Custom Packs Only</i>	50 ea/cs	

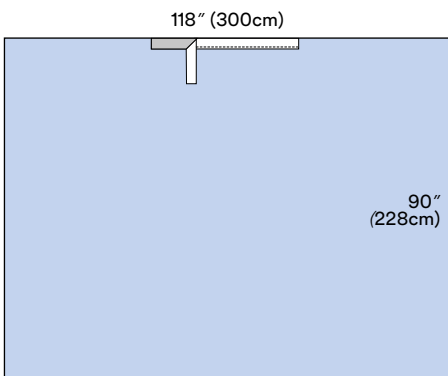

9090 Adhesive Drape Sheets

Overall Size	Drapes/Box	Boxes/Case
118" x 90" (300cm x 228cm)	12	2
9090NS (non-sterile) <i>Custom Packs Only</i>	20 ea/cs	

KEY

 Absorbent Prevention Fabric

 Standard Blue Fabric (fluid-repellent)

 Clear plastic film

 3M™ Ioban™ 2 Antimicrobial Incise Film

 3M™ Steri-Drape™ 2 Incise Film

 Adhesive area

22" (57cm)

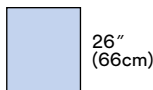
26"
(66cm)**1089 Utility Sheet (2)**

Overall Size	Drapes/Package	Packages/Box	Boxes/Case
22" x 26" (57cm x 66cm)	2	80	1
1089NS (non-sterile) <i>Custom Packs Only</i>		200 ea/cs	

35.5" (90cm)

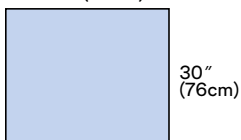
30"
(76cm)**9069 Drape Sheet**

Overall Size	Drapes/Box	Boxes/Case
35.5" x 30" (90cm x 76cm)	50	4
9069NS (non-sterile) <i>Custom Packs Only</i>		300 ea/cs

44" (114cm)

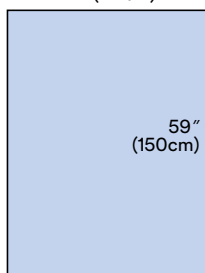
59"
(150cm)**9072 Back Table Cover**

Overall Size	Drapes/Box	Boxes/Case
44" x 59" (114cm x 150cm)	20	4
9072NS (non-sterile) <i>Custom Packs Only</i>		90 ea/cs

78" (200cm)

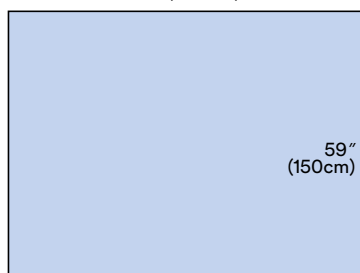
59"
(150cm)**9077 Back Table Cover**

Overall Size	Drapes/Box	Boxes/Case
78" x 59" (200cm x 152cm)	30	2
9077NS (non-sterile) <i>Custom Packs Only</i>		60 ea/cs

78" (200cm)

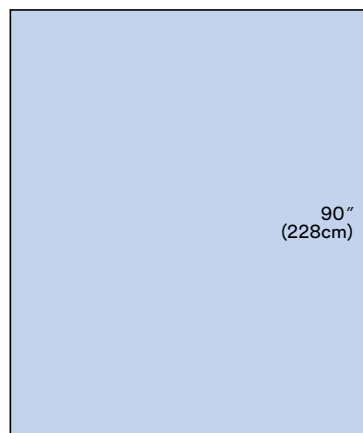
90"
(228cm)**9079 Back Table Cover**

Overall Size	Drapes/Box	Boxes/Case
78" x 90" (200cm x 228cm)	20	2
9079NS (non-sterile) <i>Custom Packs Only</i>		44 ea/cs

Absorbent
Prevention FabricStandard Blue Fabric
(fluid-repellent)

Clear plastic film

3M™ Ioban™ 2
Antimicrobial
Incise Film3M™ Steri-Drape™ 2
Incise Film

Adhesive area

KEY

SURGICAL SHEETS AND ACCESSORIES

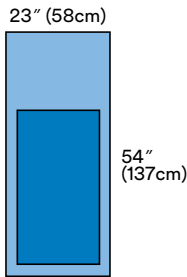

9036 Mayo Stand Cover

Overall Size	Drapes/Box	Boxes/Case
23" x 54" (58cm x 137cm)	60	4

- Blue plastic with nonwoven pad

9036NS (non-sterile) <i>Custom Packs Only</i>	300 ea/cs	
--	-----------	--

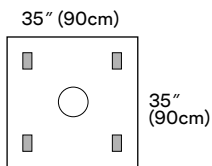

Wound Edge Protectors

	Overall Size	Ring Diameter	Drapes/Box	Boxes/Case
1073	35" x 35" (90cm x 90cm)	4 ³ / ₄ " (12cm)	10	4
1074	35" x 35" (90cm x 90cm)	6 ⁵ / ₈ " (17cm)	10	4
1075	35" x 35" (90cm x 90cm)	8 ⁵ / ₈ " (22cm)	10	4
1076	35" x 35" (90cm x 90cm)	10" (27cm)	10	4
1077	35" x 35" (90cm x 90cm)	3" (7.8cm)	10	4

- 4 – Adhesive patches

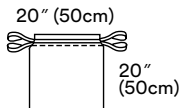

1003 Isolation Bag

Overall Size	Drapes/Box	Boxes/Case
20" x 20" (50cm x 50cm)	10	4

- Drawstring closure

1003NS (non-sterile) <i>Custom Packs Only</i>	200 ea/cs	
--	-----------	--

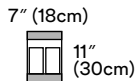

1018 Instrument Pouch

Overall Size	Drapes/Box	Boxes/Case
7" x 11" (18cm x 30cm)	10	4

- 2 – Adhesive strips
- 2 – Compartments

1018NS (non-sterile) <i>Custom Packs Only</i>	200 ea/cs	
--	-----------	--

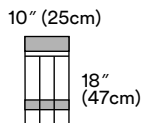

1018L Long Instrument Pouch

Overall Size	Drapes/Box	Boxes/Case
10" x 18" (25cm x 47cm)	10	4

- 2 – Adhesive strips
- 3 – Compartments

1018LNS (non-sterile) <i>Custom Packs Only</i>	200 ea/cs	
---	-----------	--

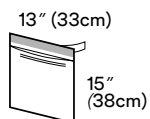

9097 Instrument Pouch (L)

Overall Size	Drapes/Box	Boxes/Case
13" x 15" (33cm x 38cm)	100	2

9097NS (non-sterile) <i>Custom Packs Only</i>	336 ea/cs	
--	-----------	--

KEY

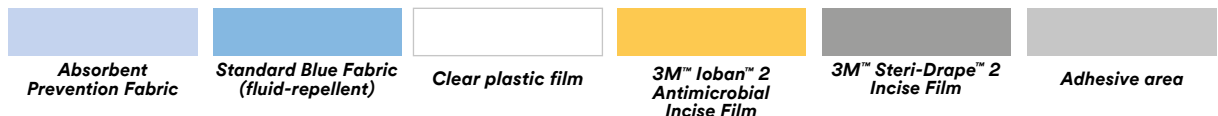

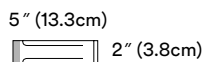

1115 Tube Organizer

Overall Size	Drapes/Box	Boxes/Case
5" x 2" (13.3cm x 3.8cm)	100	4

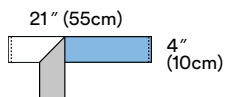

9099 Operation Tape

Overall Size	Drapes/Box	Boxes/Case
4" x 21" (10cm x 55cm)	250	2
9099NS (non-sterile) <i>Custom Packs Only</i>	1050 ea/cs	

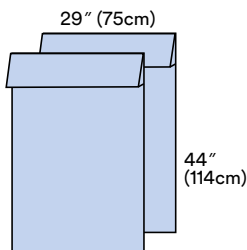

9040 Leggings (2)

Overall Size	Drapes/Box	Boxes/Case
29" x 44" (75cm x 114cm)	10	4
9040NS (non-sterile) <i>Custom Packs Only</i>	116 ea/cs	

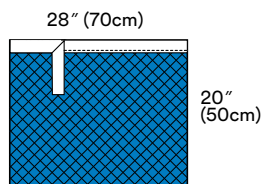

9095 Absorbent Pad

Overall Size	Drapes/Box	Boxes/Case
28" x 20" (70cm x 50cm)	50	4

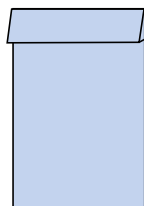

Extremity Covers

	Overall Size	Drapes/Box	Boxes/Case
9043	15" x 23" (38cm x 60cm)	50	4
9044	15" x 39" (38cm x 100cm)	35	4
9041NS (non-sterile) <i>Custom Packs Only</i>		380 ea/cs	
9042NS (non-sterile) <i>Custom Packs Only</i>		250 ea/cs	



Absorbent Material



Absorbent Prevention Fabric



Standard Blue Fabric (fluid-repellent)



Clear plastic film



3M™ Ioban™ 2 Antimicrobial Incise Film



3M™ Steri-Drape™ 2 Incise Film



Adhesive area

3M™ Steri-Drape™

FLUID COLLECTION POUCHES

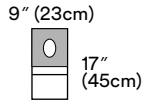

1072 Aperture Pouch Drape

Overall Size	Packs/Box	Boxes/Case
9" x 17" (23cm x 45cm)	10	4
<ul style="list-style-type: none"> • Adhesive area: 9" x 10" (23cm x 25cm) • Oval aperture: 3.5" x 4.25" (9cm x 11cm) • Fluid collection pouch 		
1072NS (non-sterile) <i>Custom Packs Only</i>	200 ea/cs	

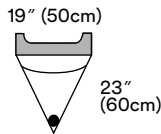

1016 Irrigation Pouch

Overall Size	Drapes/Box	Boxes/Case
19" x 23" (50cm x 60cm)	10	4
<ul style="list-style-type: none"> • Adhesive strip • 1 – Exit port • Screen 		
1016NS (non-sterile) <i>Custom Packs Only</i>	200 ea/cs	

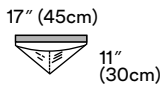

1027 Irrigation Pouch

Overall Size	Drapes/Box	Boxes/Case
17" x 11" (45cm x 30cm)	10	
<ul style="list-style-type: none"> • Adhesive area: 9" x 10" (23cm x 26cm) 		

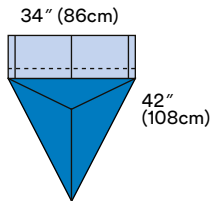

1084 Under Buttocks Drape with Pouch

Overall Size	Drapes/Box	Boxes/Case
34" x 42" (86cm x 108cm)	30	4
<ul style="list-style-type: none"> • Cuff size: 10" (25cm) • Fluid collection pouch 		
1084NS (non-sterile) <i>Custom Packs Only</i>	140 ea/cs	

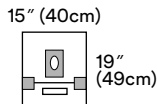

1024 Small Drape with Adhesive Aperture and Pouch

Overall Size	Drapes/Box	Boxes/Case
15" x 19" (40cm x 49cm)	10	4
<ul style="list-style-type: none"> • Adhesive area: 4" x 5" (10cm x 12.5cm) • Oval aperture: 1" x 2" (3.5cm x 6.3cm) • 2 – Adhesive patches • Fluid collection pouch 		
1024NS (non-sterile) <i>Custom Packs Only</i>	200 ea/cs	

KEY



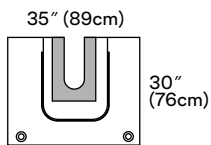

1067 U-pouch

Overall Size	Drapes/Box	Boxes/Case
35" x 30" (89cm x 76cm)	5	4

- Adhesive split: 6" x 15" (16cm x 40cm)
- Fluid collection pouch
- 2 – Exit ports

1067NS (non-sterile) <i>Custom Packs Only</i>	50 ea/cs
--	----------

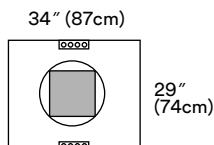

2057 Incise Pouch

Overall Size	Drapes/Box	Boxes/Case
34" x 29" (87cm x 74cm)	10	4

- Incise area: 12" x 12" (30cm x 30cm)
- 360-degree fluid collection pouch
- Tube and cord organizers

2057NS (non-sterile) <i>Custom Packs Only</i>	100 ea/cs
--	-----------

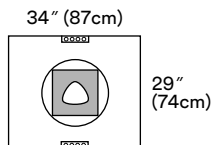

2058 Aperture Pouch Drape

Overall Size	Drapes/Box	Boxes/Case
34" x 29" (87cm x 74cm)	10	4

- Aperture incise area: 12" x 12" (30cm x 30cm)
- 360-degree fluid collection pouch
- Tube and cord organizers

2058NS (non-sterile) <i>Custom Packs Only</i>	100 ea/cs
--	-----------

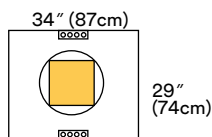

6657 Pouch with loban 2 Incise Film

Overall Size	Drapes/Box	Boxes/Case
34" x 29" (87cm x 74cm)	10	4

- loban 2 antimicrobial incise area: 11" x 11" (30cm x 30cm)
- 360-degree fluid collection pouch
- Tube and cord organizers

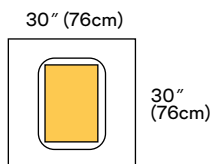

6658 Pouch with loban 2 Incise Film, Large

Overall Size	Drapes/Box	Boxes/Case
30" x 30" (76cm x 76cm)	5	4

- loban 2 antimicrobial incise area: 13" x 17" (33cm x 43cm)
- 360-degree fluid collection pouch

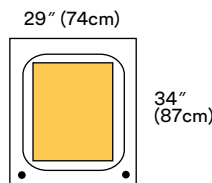

6659 Pouch with loban 2 Incise Film, Extra Large

Overall Size	Drapes/Box	Boxes/Case
29" x 34" (74cm x 87cm)	5	4

- loban 2 antimicrobial incise area: 16" x 20" (42cm x 52cm)
- 360-degree fluid collection pouch
- 2 – Exit ports



3M™ Steri-Drape™ EQUIPMENT DRAPES

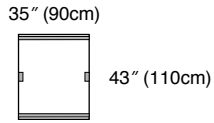

1012 Fluoroscope Drape

Overall Size	Drapes/Box	Boxes/Case
35" x 43" (90cm x 110cm)	10	4

- Adhesive strips for gathering excess materials

1012NS (non-sterile) <i>Custom Packs Only</i>	200 ea/cs
--	-----------

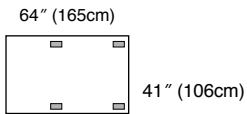

1013 C-arm Drape

Overall Size	Drapes/Box	Boxes/Case
41" x 64" (106cm x 165cm)	10	4

- Adhesive strips for gathering excess materials

1013NS (non-sterile) <i>Custom Packs Only</i>	200 ea/cs
--	-----------

KEY

Absorbent
Prevention Fabric

Standard Blue Fabric
(fluid-repellent)

Clear plastic film

3M™ Ioban™ 2
Antimicrobial
Incise Film

3M™ Steri-Drape™ 2
Incise Film

Adhesive area

For more information

For more information about 3M surgical drapes or other 3M Health Care products:

- Contact your local 3M representative
- Call the 3M Health Care Customer Helpline: **1-800-228-3957**
- Visit the 3M Health Care products Web site: **www.3M.com/Medical**



Infection Prevention Division
3M Health Care
3M Center, Building 275-4E-01
St. Paul, MN 55144-1000
U.S.A.
800-228-3957
3m.com/medical

3M, Coban, Ioban, and Steri-Drape
are trademarks of 3M Company.
Minimum 10% Post-Consumer Fiber
Printed in U.S.A.
Revised 2/18
© 3M 2002, 2003, 2005, 2006, 2017, 2018
All Rights Reserved.
70-2009-1582-8