

DC Film Capacitors MKT Axial Type



FEATURES

- Supplied loose in box, taped on ammpack or reel
- Material categorization: for definitions of compliance please see www.vishay.com/doc?99912



RoHS
COMPLIANT
HALOGEN
FREE
GREEN
(5-2008)

APPLICATIONS

Blocking, bypassing, filtering, timing, coupling and decoupling, interference suppression in low voltage applications.

QUICK REFERENCE DATA	
Capacitance range (E12 series)	470 pF to 22 μF
Capacitance tolerance	± 20 %, ± 10 %, ± 5 %
Climatic testing class according to IEC 60068-1	55/100/56
Maximum application temperature	100 °C
Reference specifications	IEC 60384-2
Dielectric	Polyester film
Electrodes	Metallized
Construction	Mono and internal series construction
Encapsulation	Plastic-wrapped, epoxy resin sealed, flame retardant
Leads	Tinned wire
Marking	C-value; tolerance; rated voltage; manufacturer's type; code for dielectric material; manufacturer location; manufacturer's logo; year and week
Rated DC voltage	63 V _{DC} , 100 V _{DC} , 250 V _{DC} , 400 V _{DC} , 630 V _{DC} , 1000 V _{DC}
Rated AC voltage	40 V _{AC} , 63 V _{AC} , 160 V _{AC} , 200 V _{AC} , 220 V _{AC}
Pull test on leads	Minimum 20 N in direction of leads according to IEC 60068-2-21
Bent test on leads	2 bends through 90° combined with 10 N tensile strength
Reliability	Operational life > 300 000 h (40 °C/0.5 U _R) Failure rate < 2 FIT (40 °C/0.5 U _R)

Note

- For more detailed data and test requirements, contact dc-film@vishay.com

DIMENSIONS in millimeters	
LEAD DIAMETER d	D
0.6	≤ 5.0
0.7	> 5.0 ≤ 7.0
0.8	> 7.0 < 16.5
1.0	≥ 16.5

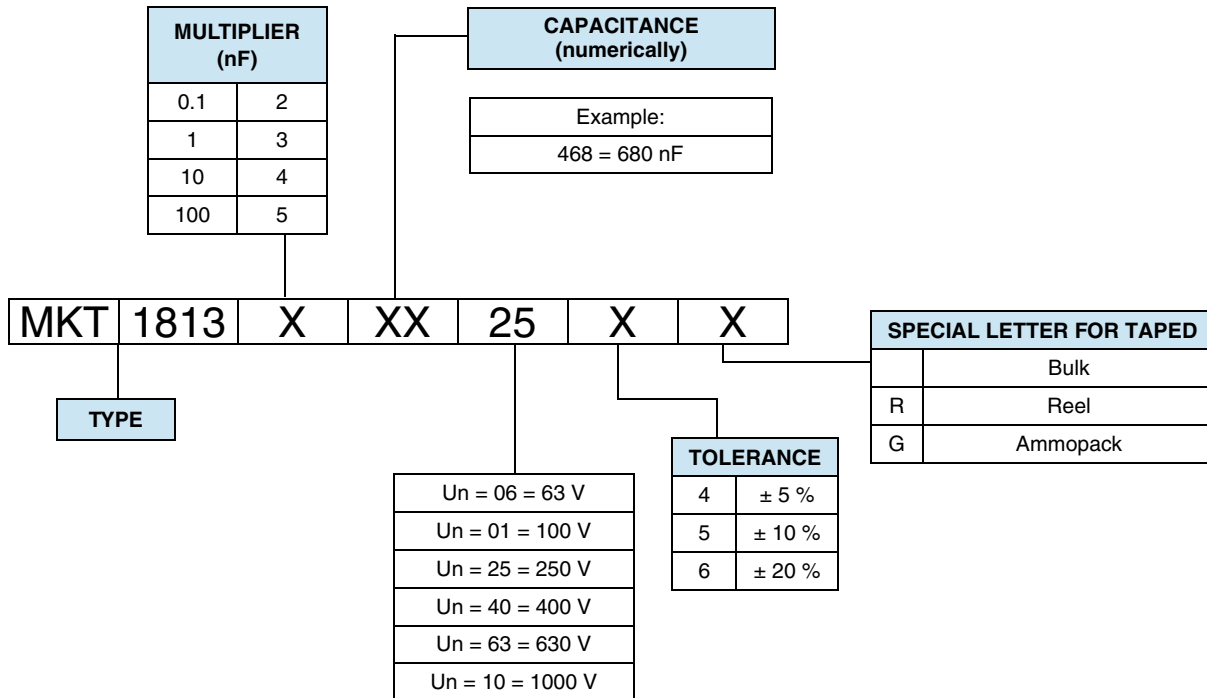
COMPOSITION OF CATALOG NUMBER

Note

- For detailed tape specifications refer to "Packaging Information" www.vishay.com/doc?28139 or end of catalog

SPECIFIC REFERENCE DATA						
DESCRIPTION				VALUE		
Tangent of loss angle: C = 0.1 μF 0.1 μF ≤ C = 1.0 μF C ≥ 1.0 μF				at 1 kHz	at 10 kHz	at 100 kHz
				80 x 10 ⁻⁴	150 x 10 ⁻⁴	250 x 10 ⁻⁴
				80 x 10 ⁻⁴	150 x 10 ⁻⁴	-
			100 x 10 ⁻⁴	-	-	-
CAPACITOR LENGTH (mm)	MAXIMUM PULSE RISE TIME (dU/dt) _R [V/μs]					
	63 V _{DC}	100 V _{DC}	250 V _{DC}	400 V _{DC}	630 V _{DC}	1000 V _{DC}
11	12	18	32	56	84	-
14	11	13	22	37	66	175
19	7	8	13	21	33	65
26.5	4	5	8	13	19	34
31.5	3	4	6	10	15	25
41.5	2	3	5	7	10	17
If the maximum pulse voltage is less than the rated voltage higher dU/dt values can be permitted.						
R between leads, for C ≤ 0.33 μF and U _R ≤ 100 V					> 15 000 MΩ	
R between leads, for C ≤ 0.33 μF and U _R > 100 V					> 30 000 MΩ	
RC between leads, for C > 0.33 μF and U _R ≤ 100 V					> 5000 s	
RC between leads, for C > 0.33 μF and U _R > 100 V					> 10 000 s	
R between leads and case, 100 V; (foil method)					> 30 000 MΩ	
Withstanding (DC) voltage (cut off current 10 mA); rise time 100 V/s					1.6 x U _{RDC} , 1 min	
Maximum application temperature					100 °C	



ELECTRICAL DATA						
U _{RDC} (V)	CAP. (μF)	CAPACITANCE CODE	VOLTAGE CODE	V _{AC}	DIMENSIONS	
					D	L
63	0.15	415	06	40	5.0	11.0
	0.22	422			5.0	11.0
	0.33	433			-	-
	0.47	447			6.0	14.0
	0.68	468			-	-
	1.0	510			7.0	14.0
	1.5	515			-	-
	2.2	522			6.5	19.0
	3.3	533			-	-
	4.7	547			7.5	19.0
	6.8	568			8.5	19.0
	10.0	610			-	-
	15.0	615			8.5	26.5
	22.0	622			7.5	19.0 ⁽²⁾
	100	0.068			368	01
0.10		410	5.0	11.0		
0.15		415	-	-		
0.22		422	5.5	11.0		
0.33		433	6.0	14.0		
0.47		447	-	-		
0.68		468	6.0	19.0		
1.0		510	-	-		
1.5		515	6.5	19.0		
2.2		522	-	-		
3.3		533	7.0	19.0		
4.7		547	-	-		
6.8		568	8.5	19.0		
10.0		610	8.0	26.5		
15.0		615	8.0	19.0 ⁽²⁾		
		9.5	26.5			
		9.5	19.0 ⁽²⁾			
		11.5	26.5			
		-	-			
		12.0	31.5			
		-	-			
		14.0	31.5			
		16.5	31.5			
		13.5	31.5 ⁽²⁾			
		20.5	31.5			



ELECTRICAL DATA						
U _{RDC} (V)	CAP. (μF)	CAPACITANCE CODE	VOLTAGE CODE	V _{AC}	DIMENSIONS	
					D	L
250	0.015	315	25	160	5.0	11.0
	0.022	322			5.0	11.0
	0.033	333			5.0	11.0
	0.047	347			6.0	14.0
	0.068	368			6.0	14.0
	0.10	410			6.0	14.0
	0.15	415			-	-
	0.22	422			7.0	14.0
	0.33	433			7.0	19.0
	0.47	447			-	-
	0.68	468			8.0	19.0
	1.0	510			-	-
	1.5	515			9.0	19.0
	2.2	522			-	-
	3.3	533			8.5	26.5
	4.7	547			9.0	19.0 ⁽²⁾
	6.8	568			10.0	26.5
	10.0	610			11.0	31.5
400	0.0068	268	40	200	5.0	11.0
	0.010	310			5.0	11.0
	0.015	315			6.0	14.0
	0.022	322			6.0	14.0
	0.033	333			6.0	14.0
	0.047	347			6.0	14.0
	0.068	368			7.0	14.0
	0.10	410			8.0	14.0
	0.15	415			7.0	19.0
	0.22	422			-	-
	0.33	433			8.5	19.0
	0.47	447			8.0	26.5
	0.68	468			8.0	19.0 ⁽²⁾
	1.0	510			9.5	26.5
	1.5	515			9.5	19.0 ⁽²⁾
	2.2	522			11.0	26.5
					-	-
					11.5	31.5
		-	-			
		13.5	31.5			
		14.0	41.5			
		13.0	31.5 ⁽²⁾			
		16.5	41.5			
		-	-			



ELECTRICAL DATA						
U _{RDC} (V)	CAP. (μF)	CAPACITANCE CODE	VOLTAGE CODE	V _{AC}	DIMENSIONS	
					D	L
630	0.00047	147	63 ⁽¹⁾	220	5.0	11.0
	0.00068	168			5.0	11.0
	0.0010	210			5.0	11.0
	0.0015	215			5.0	11.0
	0.0022	222			5.0	11.0
	0.0033	233			5.0	11.0
	0.0047	247			5.0	11.0
	0.0068	268			6.0	14.0
	0.010	310			6.0	14.0
	0.015	315			6.5	14.0
	0.022	322			7.5	14.0
	0.033	333			6.5	19.0
	0.047	347			7.5	19.0
	0.068	368			8.5	19.0
	0.10	410			10.5	19.0
	0.15	415			9.5	19.0 ⁽²⁾
	0.22	422			10.0	26.5
	0.33	433			11.5	26.5
	0.47	447			-	-
	0.68	468			13.5	26.5
1.0	510	-	-			
1000	0.0010	210	10 ⁽¹⁾	220	5.5	14.0
	0.0015	215			6.0	14.0
	0.0022	222			6.0	14.0
	0.0033	233			7.0	14.0
	0.0047	247			6.0	19.0
	0.0068	268			6.0	19.0
	0.010	310			6.5	19.0
	0.015	315			7.5	19.0
	0.022	322			9.0	19.0
	0.033	333			10.5	19.0
	0.047	347			12.0	19.0
	0.068	368			11.0	26.5
	0.10	410			13.0	26.5
	0.15	415			-	-
	0.22	422			13.5	31.5
	0.33	433			16.0	31.5
	0.47	447			-	-
					16.0	41.5
		-	-			
		19.0	41.5			
		-	-			

Notes

- Pitch = L + 3.5
- ⁽¹⁾ Not suitable for mains applications
- ⁽²⁾ For the smaller size please add "-M" at the end of the type designation (e.g. MKT1813-510/255-M)

RECOMMENDED PACKAGING				
PACKAGING CODE	TYPE OF PACKAGING	REEL DIAMETER (mm)	ORDERING CODE EXAMPLES	
G	Ammo	-	MKT1813-422-014-G	x
R	Reel	350	MKT1813-422-014-R	x
-	Bulk	-	MKT1813-422-014	x

Note

- Attention: Capacitors with L > 31.5 mm only as bulk available

EXAMPLE OF ORDERING CODE				
TYPE	CAPACITANCE CODE	VOLTAGE CODE	TOLERANCE CODE ⁽¹⁾	PACKAGING CODE
MKT1813	410	06	5	G

Note

- ⁽¹⁾ Tolerance codes: 4 = 5 % (J); 5 = 10 % (K); 6 = 20 % (M)

MOUNTING
Normal Use

The capacitors are designed for mounting on printed-circuit boards. The capacitors packed in bandoliers are designed for mounting in printed-circuit boards by means of automatic insertion machines.

For detailed tape specifications refer to packaging information: www.vishay.com/doc?28139 or end of catalog.

Specific Method of Mounting to Withstand Vibration and Shock

In order to withstand vibration and shock tests, it must be ensured that the capacitor body is in good contact with the printed-circuit board:

- For $L \leq 19$ mm capacitors shall be mechanically fixed by the leads.
- For larger pitches the capacitors shall be mounted in the same way and the body clamped.
- The maximum diameter and length of the capacitors are specified in the "Dimensions" table.
- Eccentricity as shown in the drawing below.

Space Requirements on Printed-Circuit Board

The maximum length and width of film capacitors is shown in the drawing:

- Eccentricity as in drawing. The maximum eccentricity is smaller than or equal to the lead diameter of the product concerned.
- Product height with seating plane as given by "IEC 60717" as reference: $h_{max} \leq h + 0.4$ mm or $h_{max} \leq h' + 0.4$ mm

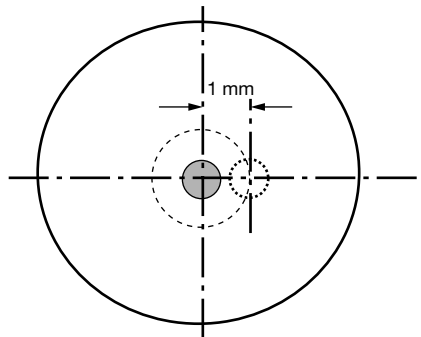
Storage Temperature

$T_{stg} = -25$ °C to $+35$ °C with RH maximum 75 % without condensation

Ratings and Characteristics Reference Conditions

Unless otherwise specified, all electrical values apply to an ambient temperature of 23 °C ± 1 °C, an atmospheric pressure of 86 kPa to 106 kPa and a relative humidity of 50 % ± 2 %.

For reference testing, a conditioning period shall be applied over 96 h ± 4 h by heating the products in a circulating air oven at the rated temperature and a relative humidity not exceeding 20 %.



CHARACTERISTICS

PERMISSIBLE AC VOLTAGE VS. FREQUENCY

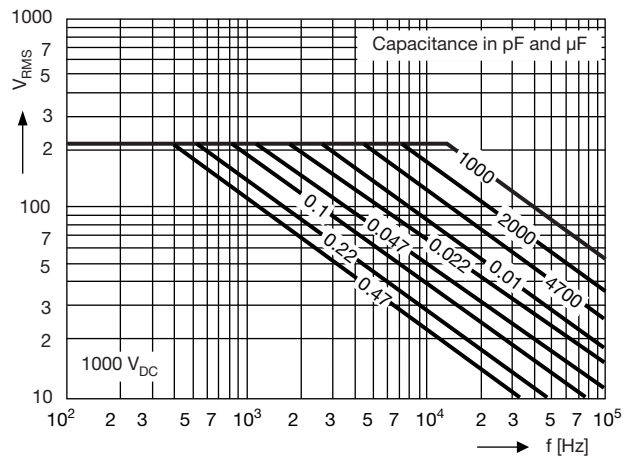
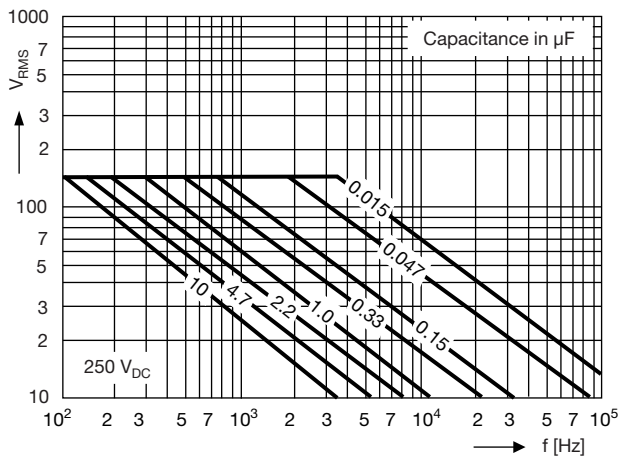
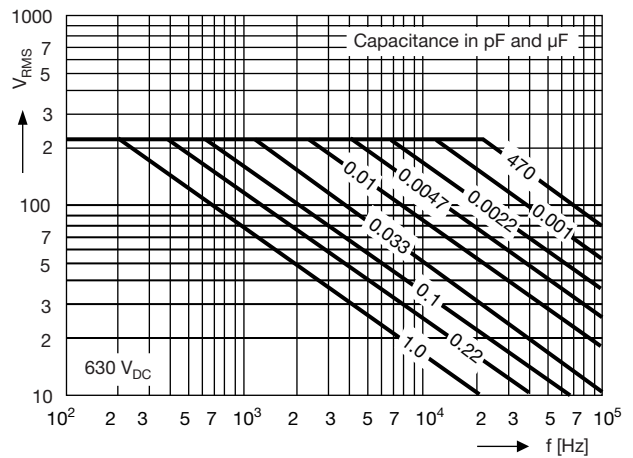
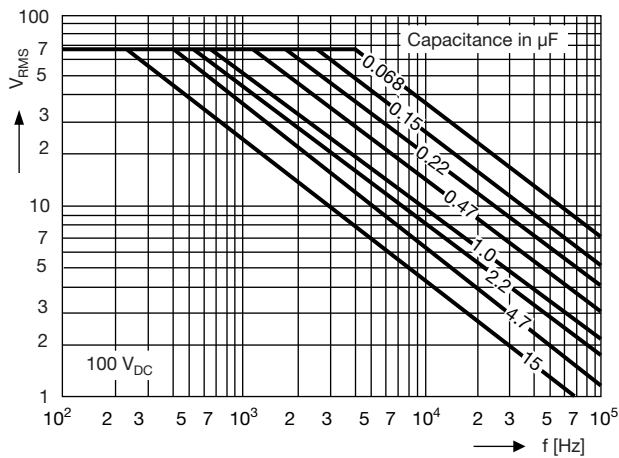
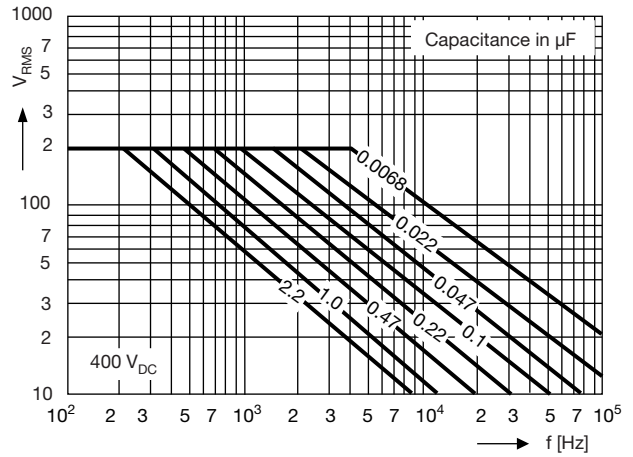
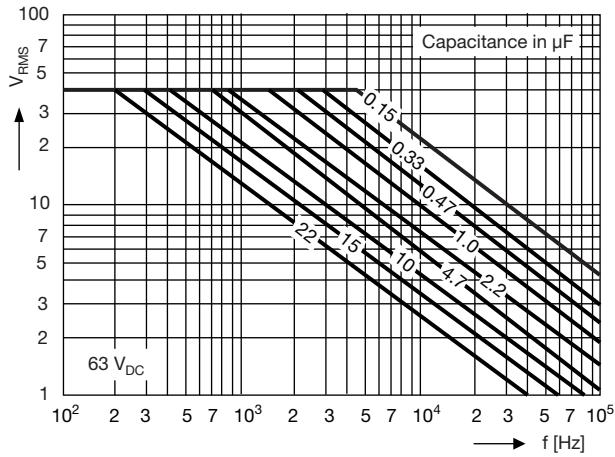



CHARACTERISTICS

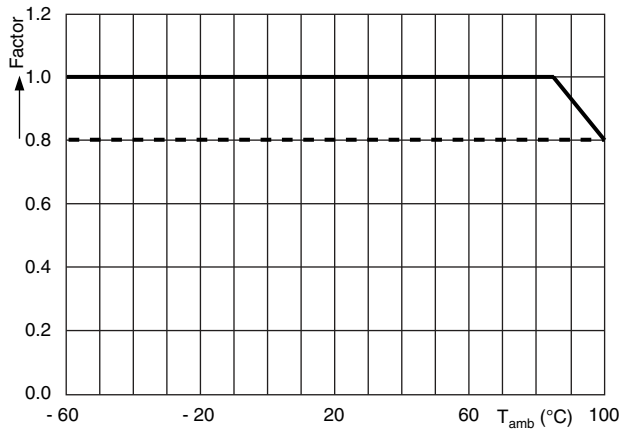

Nominal voltage (AC and DC) as a function of temperature
 $U = f(T_A), T_{LL} \leq T_A \leq T_{UL}$

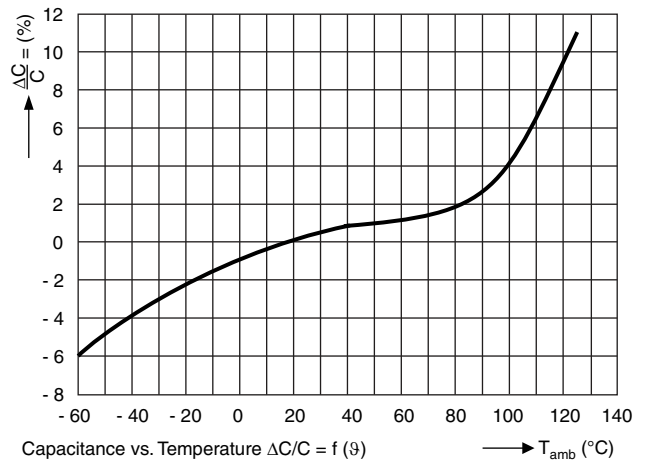

Capacitance as a function of temperature
 $\Delta C/C = f(T_A), T_{LL} \leq T_A \leq T_{UL}$

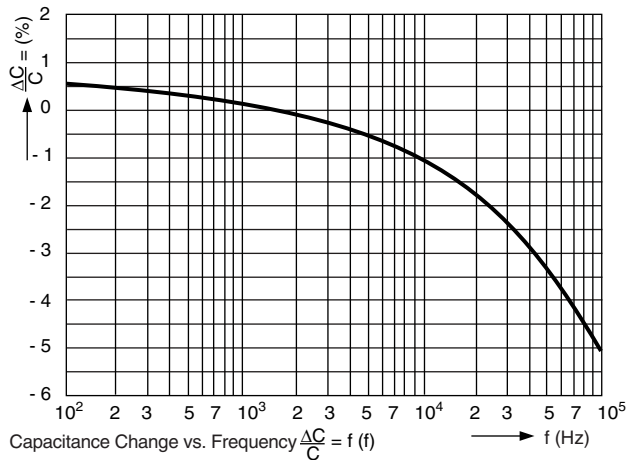

Capacitance as function of frequency
 $\Delta C/C = f(f), 100 \text{ Hz} \leq f \leq 1 \text{ MHz}$

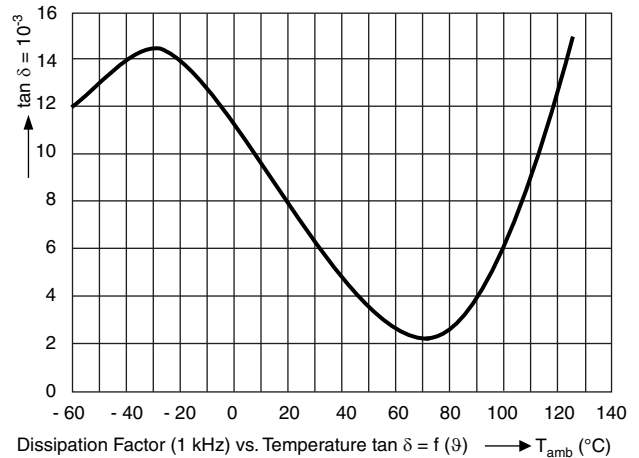

Dissipation factor as function of temperature
 $\Delta \tan \delta / \tan \delta = f(T_A), T_{LL} \leq T_A \leq T_{UL}$

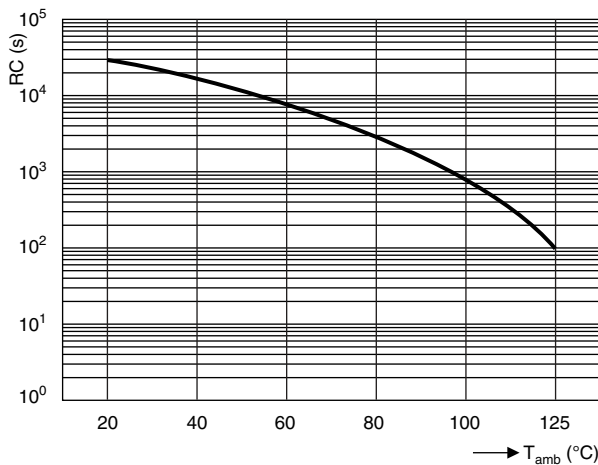

Insulation resistance as a function of temperature
 $R_{is} = f(T_A), T_{LL} \leq T_A \leq T_{UL}$

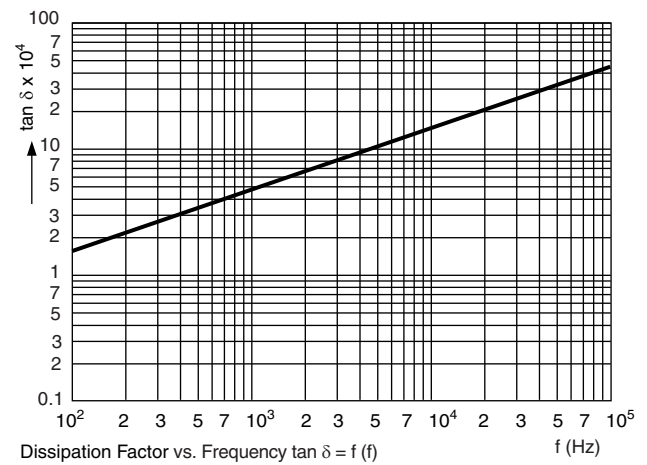

Dissipation factor as a function of frequency
 $\Delta \tan \delta / \tan \delta = f(f), 100 \text{ Hz} \leq f \leq 1 \text{ MHz}_L$



CHARACTERISTICS

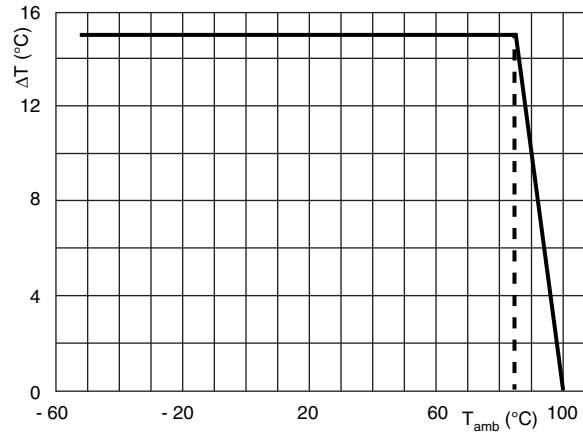

Maximum allowed component temperature rise (ΔT) as a function of the ambient temperature (T_{amb})

HEAT CONDUCTIVITY (G) AS A FUNCTION OF (ORIGINAL) PITCH AND CAPACITOR BODY THICKNESS IN mW/°C						
D_{max.} (mm)	HEAT CONDUCTIVITY (mW/°C)					
	L = 11 mm	L = 14 mm	L = 19 mm	L = 26.5 mm	L = 31.5 mm	L = 41.5 mm
5.0	2	-	-	-	-	-
5.5	2	3	-	-	-	-
6.0	-	3	4	-	-	-
6.5	-	3	5	-	-	-
7.0	-	4	5	-	-	-
7.5	-	-	6	-	-	-
8.0	-	4	-	8	-	-
8.5	-	-	6	9	-	-
9.0	-	-	7	-	-	-
9.5	-	-	-	10	-	-
10.0	-	-	-	11	-	-
10.5	-	-	8	-	-	-
11.0	-	-	-	12	14	-
11.5	-	-	-	13	15	-
12.0	-	-	9	-	16	-
12.5	-	-	-	-	-	-
13.0	-	-	-	14	17	-
13.5	-	-	-	15	18	-
14.0	-	-	-	16	19	-
14.5	-	-	-	-	19	-
15.0	-	-	-	-	-	-
15.5	-	-	-	-	21	-
16.0	-	-	-	-	-	29
16.5	-	-	-	-	22	30
17.0	-	-	-	-	-	-
17.5	-	-	-	-	-	31
18.0	-	-	-	-	24	-
18.5	-	-	-	-	-	-
19.0	-	-	-	-	-	34
20.0	-	-	-	-	-	-
20.5	-	-	-	-	28	-
21.0	-	-	-	-	-	38

POWER DISSIPATION AND MAXIMUM COMPONENT TEMPERATURE RISE

The power dissipation must be limited in order not to exceed the maximum allowed component temperature rise as a function of the free ambient temperature.

The power dissipation can be calculated according type detail specification “HQN-384-01/101: Technical Information Film Capacitors”.

The component temperature rise (ΔT) can be measured (see section “Measuring the component temperature” for more details) or calculated by $\Delta T = P/G$:

- ΔT = Component temperature rise ($^{\circ}C$)
- P = Power dissipation of the component (mW)
- G = Heat conductivity of the component ($mW/^{\circ}C$)

MEASURING THE COMPONENT TEMPERATURE

A thermocouple must be attached to the capacitor body as in:

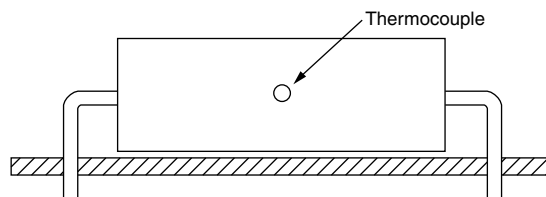

The temperature is measured in unloaded (T_{amb}) and maximum loaded condition (T_C).

The temperature rise is given by $\Delta T = T_C - T_{amb}$.

To avoid radiation or convection, the capacitor should be tested in a wind-free box.

APPLICATION NOTE AND LIMITING CONDITIONS

These capacitors are not suitable for mains applications as across-the-line capacitors without additional protection, as described hereunder. These mains applications are strictly regulated in safety standards and therefore electromagnetic interference suppression capacitors conforming the standards must be used.

To select the capacitor for a certain application, the following conditions must be checked:

1. The peak voltage (U_P) shall not be greater than the rated DC voltage (U_{RDC})
2. The peak-to-peak voltage (U_{P-P}) shall not be greater than $2\sqrt{2} \times U_{RAC}$ to avoid the ionization inception level
3. The voltage peak slope (dU/dt) shall not exceed the rated voltage pulse slope in an RC-circuit at rated voltage and without ringing. If the pulse voltage is lower than the rated DC voltage, the rated voltage pulse slope may be multiplied by U_{Rdc} and divided by the applied voltage.

For all other pulses following equation must be fulfilled:

$$2 \times \int_0^T \left(\frac{dU}{dt}\right)^2 \times dt < U_{RDC} \times \left(\frac{dU}{dt}\right)_{rated}$$

T is the pulse duration.

The rated voltage pulse slope is valid for ambient temperatures up to $85^{\circ}C$. For higher temperatures a derating factor of 3 % per K shall be applied.

4. The maximum component surface temperature rise must be lower than the limits (see figure “Max. allowed component temperature rise”).
5. Since in circuits used at voltages over 280 V peak-to-peak the risk for an intrinsically active flammability after a capacitor breakdown (short circuit) increases, it is recommended that the power to the component is limited to 100 times the values mentioned in the table “Heat Conductivity”.
6. When using these capacitors as across-the-line capacitor in the input filter for mains applications the applicant must guarantee that the following conditions are fulfilled in any case (spikes and surge voltages from the mains included).
7. For continuous use as series connection with an impedance to the mains, please refer to application note www.vishay.com/doc?28153.

VOLTAGE CONDITIONS FOR 6 ABOVE		
ALLOWED VOLTAGES	$T_{amb} \leq 85\text{ }^{\circ}\text{C}$	$85\text{ }^{\circ}\text{C} < T_{amb} \leq 100\text{ }^{\circ}\text{C}$
Maximum continuous RMS voltage	U_{RAC}	$0.8 \times U_{RAC}$
Maximum temperature RMS-overvoltage (< 24 h)	$1.25 \times U_{RAC}$	U_{RAC}
Maximum peak voltage (V_{O-P}) (< 2 s)	$1.6 \times U_{RDC}$	$1.3 \times U_{RDC}$

Example

$C = 3300\text{ nF} - 100\text{ V}$ used for the voltage signal shown in next figure.

$U_{P-P} = 80\text{ V}$; $U_P = 70\text{ V}$; $T_1 = 0.5\text{ ms}$; $T_2 = 1\text{ ms}$

The ambient temperature is $35\text{ }^{\circ}\text{C}$

Checking conditions:

1. The peak voltage $U_P = 70\text{ V}$ is lower than 100 V_{DC}
2. The peak-to-peak voltage 80 V is lower than $2\sqrt{2} \times 63\text{ V}_{AC} = 178\text{ V}_{P-P}$
3. The voltage pulse slope $(dU/dt) = 80\text{ V}/500\text{ }\mu\text{s} = 0.16\text{ V}/\mu\text{s}$
This is lower than $8\text{ V}/\mu\text{s}$ (see "Specific Reference Data" for each version)
4. The dissipated power is 60 mW as calculated with fourier terms
The temperature rise for $W_{max.} = 11.5\text{ mm}$ and pitch = 26.5 mm will be $60\text{ mW}/13\text{ mW}/^{\circ}\text{C} = 4.6\text{ }^{\circ}\text{C}$
This is lower than $15\text{ }^{\circ}\text{C}$ temperature rise at $35\text{ }^{\circ}\text{C}$, according figure "Maximum allowed component temperature rise"
5. Not applicable
6. Not applicable
7. Not applicable

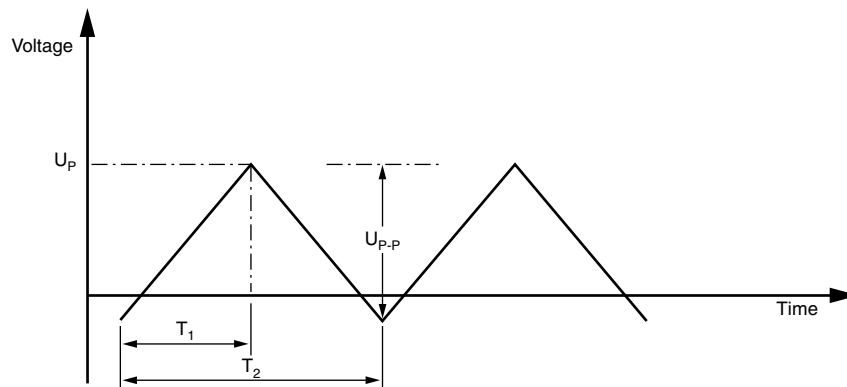
Voltage Signal



INSPECTION REQUIREMENTS

General Notes

Sub-clause numbers of tests and performance requirements refer to the “Sectional Specification, Publication IEC 60384-2 and Specific Reference Data”.

GROUP C INSPECTION REQUIREMENTS		
SUB-CLAUSE NUMBER AND TEST	CONDITIONS	PERFORMANCE REQUIREMENTS
SUB-GROUP C1A PART OF SAMPLE OF SUB-GROUP C1		
4.1 Dimensions (detail)		As specified in Chapters “General data” of this specification
4.3.1 Initial measurements	Capacitance Tangent of loss angle: For C ≤ 470 nF at 100 kHz or for C > 470 nF at 10 kHz	
4.3 Robustness of terminations	Tensile: Load 10 N; 10 s Bending: Load 5 N; 4 x 90°	No visible damage
4.4 Resistance to soldering heat	Method: 1A Solder bath: 280 °C ± 5 °C Duration: 10 s	
4.14 Component solvent resistance	Isopropylalcohol at room temperature Method: 2 Immersion time: 5 min ± 0.5 min Recovery time: Min. 1 h, max. 2 h	
4.4.2 Final measurements	Visual examination	No visible damage Legible marking
	Capacitance	$ \Delta C/C \leq 2\%$ of the value measured initially
	Tangent of loss angle	Increase of tan δ ≤ 0.005 for: C ≤ 100 nF or ≤ 0.010 for: 100 nF < C ≤ 220 nF or ≤ 0.015 for: 220 nF < C ≤ 470 nF and ≤ 0.003 for: C > 470 nF Compared to values measured in 4.3.1
SUB-GROUP C1B PART OF SAMPLE OF SUB-GROUP C1		
4.6.1 Initial measurements	Capacitance Tangent of loss angle: For C ≤ 470 nF at 100 kHz or for C > 470 nF at 10 kHz	
4.6 Rapid change of temperature	θA = - 55 °C θB = + 100 °C 5 cycles Duration t = 30 min Visual examination	No visible damage
4.7 Vibration	Mounting: See section “Mounting” of this specification Procedure B4 Frequency range: 10 Hz to 55 Hz Amplitude: 0.75 mm or Acceleration 98 m/s ² (whichever is less severe) Total duration 6 h	
4.7.2 Final inspection	Visual examination	No visible damage



GROUP C INSPECTION REQUIREMENTS		
SUB-CLAUSE NUMBER AND TEST	CONDITIONS	PERFORMANCE REQUIREMENTS
SUB-GROUP C1B PART OF SAMPLE OF SUB-GROUP C1		
4.9 Shock	Mounting: See section "Mounting" of this specification Pulse shape: Half sine Acceleration: 490 m/s ² Duration of pulse: 11 ms	
4.9.3 Final measurements	Visual examination Capacitance Tangent of loss angle Insulation resistance	No visible damage $ \Delta C/C \leq 3\%$ of the value measured in 4.6.1 Increase of $\tan \delta$ ≤ 0.005 for: $C \leq 100$ nF or ≤ 0.010 for: 100 nF $< C \leq 220$ nF or ≤ 0.015 for: 220 nF $< C \leq 470$ nF and ≤ 0.003 for: $C > 470$ nF Compared to values measured in 4.6.1 As specified in section "Insulation Resistance" of this specification
SUB-GROUP C1 COMBINED SAMPLE OF SPECIMENS OF SUB-GROUPS C1A AND C1B		
4.10 Climatic sequence		
4.10.2 Dry heat	Temperature: + 100 °C Duration: 16 h	
4.10.3 Damp heat cyclic Test Db, first cycle		
4.10.4 Cold	Temperature: - 55 °C Duration: 2 h	
4.10.6 Damp heat cyclic Test Db, remaining cycles		
4.10.6.2 Final measurements	Voltage proof = U_{RDC} for 1 min within 15 min after removal from testchamber Visual examination Capacitance Tangent of loss angle Insulation resistance	No breakdown of flash-over No visible damage Legible marking $ \Delta C/C \leq 5\%$ of the value measured in 4.4.2 or 4.9.3 Increase of $\tan \delta$ ≤ 0.007 for: $C \leq 100$ nF or ≤ 0.010 for: 100 nF $< C \leq 220$ nF or ≤ 0.015 for: 220 nF $< C \leq 470$ nF and ≤ 0.005 for: $C > 470$ nF Compared to values measured in 4.3.1 or 4.6.1 $\geq 50\%$ of values specified in section "Insulation resistance" of this specification
SUB-GROUP C2		
4.11 Damp heat steady state	56 days, 40 °C, 90 % to 95 % RH	
4.11.1 Initial measurements	Capacitance Tangent of loss angle at 1 kHz	



GROUP C INSPECTION REQUIREMENTS		
SUB-CLAUSE NUMBER AND TEST	CONDITIONS	PERFORMANCE REQUIREMENTS
SUB-GROUP C2		
4.11.3 Final measurements	Voltage proof = U_{RDC} for 1 min within 15 min after removal from testchamber Visual examination Capacitance Tangent of loss angle Insulation resistance	No breakdown of flash-over No visible damage Legible marking $ \Delta C/C \leq 5\%$ of the value measured in 4.11.1 Increase of $\tan \delta \leq 0.005$ Compared to values measured in 4.11.1 $\geq 50\%$ of values specified in section "Insulation resistance" of this specification
SUB-GROUP C3		
4.12 Endurance	Duration: 2000 h $1.25 \times U_{RDC}$ at 85 °C $1.0 \times U_{RDC}$ at 100 °C	
4.12.1 Initial measurements	Capacitance Tangent of loss angle: For $C \leq 470$ nF at 100 kHz or for $C > 470$ nF at 10 kHz	
4.12.5 Final measurements	Visual examination Capacitance Tangent of loss angle Insulation resistance	No visible damage Legible marking $ \Delta C/C \leq 5\%$ compared to values measured in 4.12.1 Increase of $\tan \delta$ ≤ 0.005 for: $C \leq 100$ nF or ≤ 0.010 for: 100 nF < $C \leq 220$ nF or ≤ 0.015 for: 220 nF < $C \leq 470$ nF and ≤ 0.003 for: $C > 470$ nF Compared to values measured in 4.12.1 $\geq 50\%$ of values specified in section "Insulation resistance" of this specification
SUB-GROUP C4		
4.13 Charge and discharge	10 000 cycles Charged to U_{RDC} Discharge resistance: $R = \frac{U_R}{C \times 2.5 \times (dU/dt)_R}$	
4.13.1 Initial measurements	Capacitance Tangent of loss angle: For $C \leq 470$ nF at 100 kHz or for $C > 470$ nF at 10 kHz	
4.13.3 Final measurements	Capacitance Tangent of loss angle Insulation resistance	$ \Delta C/C \leq 3\%$ compared to values measured in 4.13.1 Increase of $\tan \delta$ ≤ 0.005 for: $C \leq 100$ nF or ≤ 0.010 for: 100 nF < $C \leq 220$ nF or ≤ 0.015 for: 220 nF < $C \leq 470$ nF and ≤ 0.003 for: $C > 470$ nF Compared to values measured in 4.13.1 $\geq 50\%$ of values specified in section "Insulation resistance" of this specification



Disclaimer

ALL PRODUCT, PRODUCT SPECIFICATIONS AND DATA ARE SUBJECT TO CHANGE WITHOUT NOTICE TO IMPROVE RELIABILITY, FUNCTION OR DESIGN OR OTHERWISE.

Vishay Intertechnology, Inc., its affiliates, agents, and employees, and all persons acting on its or their behalf (collectively, "Vishay"), disclaim any and all liability for any errors, inaccuracies or incompleteness contained in any datasheet or in any other disclosure relating to any product.

Vishay makes no warranty, representation or guarantee regarding the suitability of the products for any particular purpose or the continuing production of any product. To the maximum extent permitted by applicable law, Vishay disclaims (i) any and all liability arising out of the application or use of any product, (ii) any and all liability, including without limitation special, consequential or incidental damages, and (iii) any and all implied warranties, including warranties of fitness for particular purpose, non-infringement and merchantability.

Statements regarding the suitability of products for certain types of applications are based on Vishay's knowledge of typical requirements that are often placed on Vishay products in generic applications. Such statements are not binding statements about the suitability of products for a particular application. It is the customer's responsibility to validate that a particular product with the properties described in the product specification is suitable for use in a particular application. Parameters provided in datasheets and / or specifications may vary in different applications and performance may vary over time. All operating parameters, including typical parameters, must be validated for each customer application by the customer's technical experts. Product specifications do not expand or otherwise modify Vishay's terms and conditions of purchase, including but not limited to the warranty expressed therein.

Hyperlinks included in this datasheet may direct users to third-party websites. These links are provided as a convenience and for informational purposes only. Inclusion of these hyperlinks does not constitute an endorsement or an approval by Vishay of any of the products, services or opinions of the corporation, organization or individual associated with the third-party website. Vishay disclaims any and all liability and bears no responsibility for the accuracy, legality or content of the third-party website or for that of subsequent links.

Except as expressly indicated in writing, Vishay products are not designed for use in medical, life-saving, or life-sustaining applications or for any other application in which the failure of the Vishay product could result in personal injury or death. Customers using or selling Vishay products not expressly indicated for use in such applications do so at their own risk. Please contact authorized Vishay personnel to obtain written terms and conditions regarding products designed for such applications.

No license, express or implied, by estoppel or otherwise, to any intellectual property rights is granted by this document or by any conduct of Vishay. Product names and markings noted herein may be trademarks of their respective owners.