

CUSTOMER PRINT

PART NUMBER: W5Z85-XPG-P-3XX

NOTES:

1. ALL PARTS TO BE BULK PACKED UNLESS NOTED.
2. INSTA CLICK IN LINE CABLE ASSEMBLY IS SUPPLIED AS A KIT. CONTACTS (3-4), HEX SCREWS ARE ALL ASSEMBLED.
3. ALL DIMENSIONS ARE REFERENCED IN INCHES [MM], WITHIN ± 0.015 UNLESS NOTED.

PART NUMBER SYSTEM

W5Z85-XPG-P-3XX

SCREW TERMINAL CONTACT
SIZE #14
CONTACT POSITION
[3 & 4]

GROMMET SIZE & CABLE OD RANGE (LARGER TO SMALLER)
35 - .375 GROMMET I.D FOR CABLE OD .35-.40 [8.9 - 10.2]
30- .312 GROMMET I.D FOR CABLE OD .30-.32 [7.6 - 8.1]
28- .285 GROMMET I.D FOR CABLE OD .28-.29 [7.1 - 7.4]

ASSEMBLY PART NUMBERS	CABLE OD RANGE
W5Z85-3PG-P-328	0.28 - 0.29
W5Z85-3PG-P-330	0.30 - 0.32
W5Z85-3PG-P-335	0.35 - 0.40
W5Z85-4PG-P-328	0.28 - 0.29
W5Z85-4PG-P-330	0.30 - 0.32
W5Z85-4PG-P-335	0.35 - 0.40

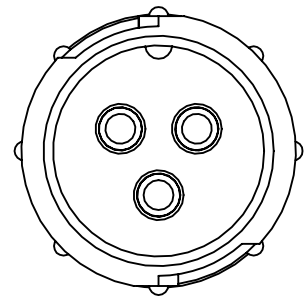

MATING FACE
ASSY: 5Z85-3PG-P-3XX

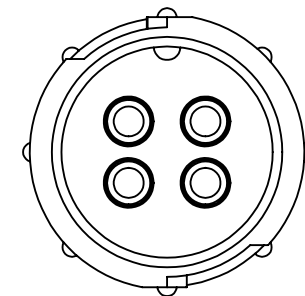

MATING FACE
ASSY: 5Z85-4PG-P-3XX

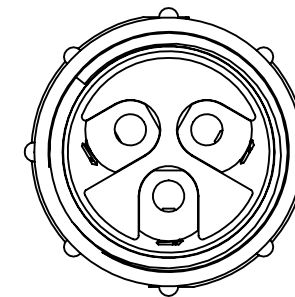
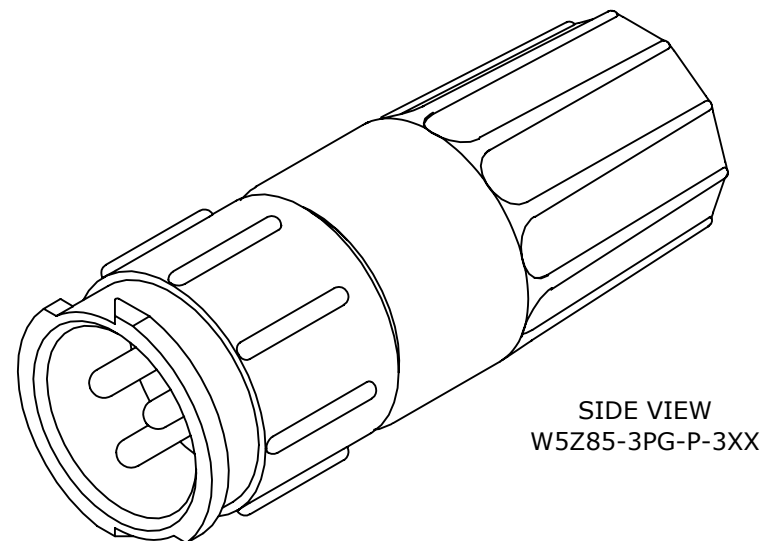
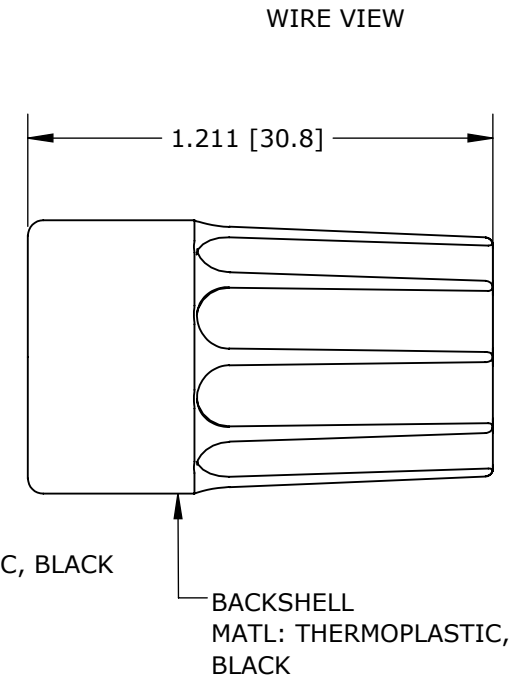
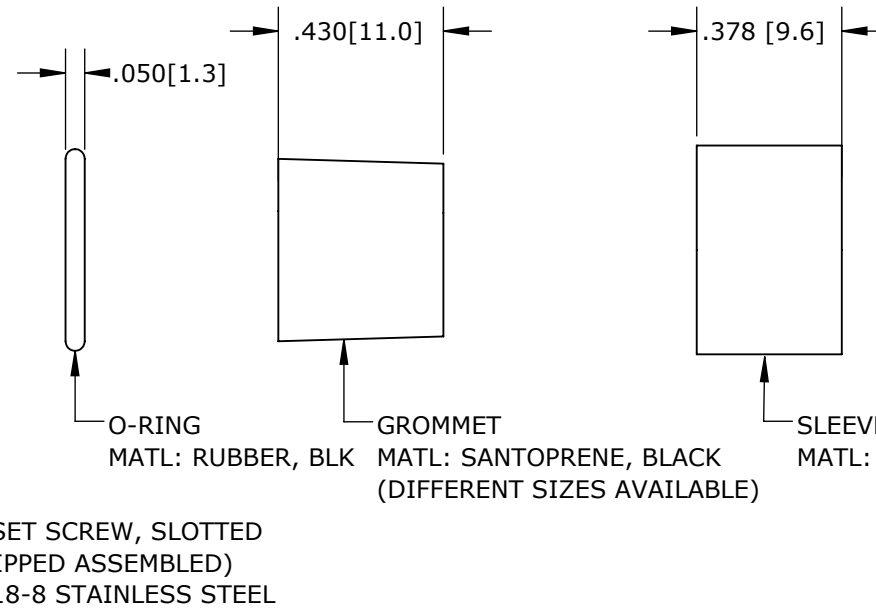
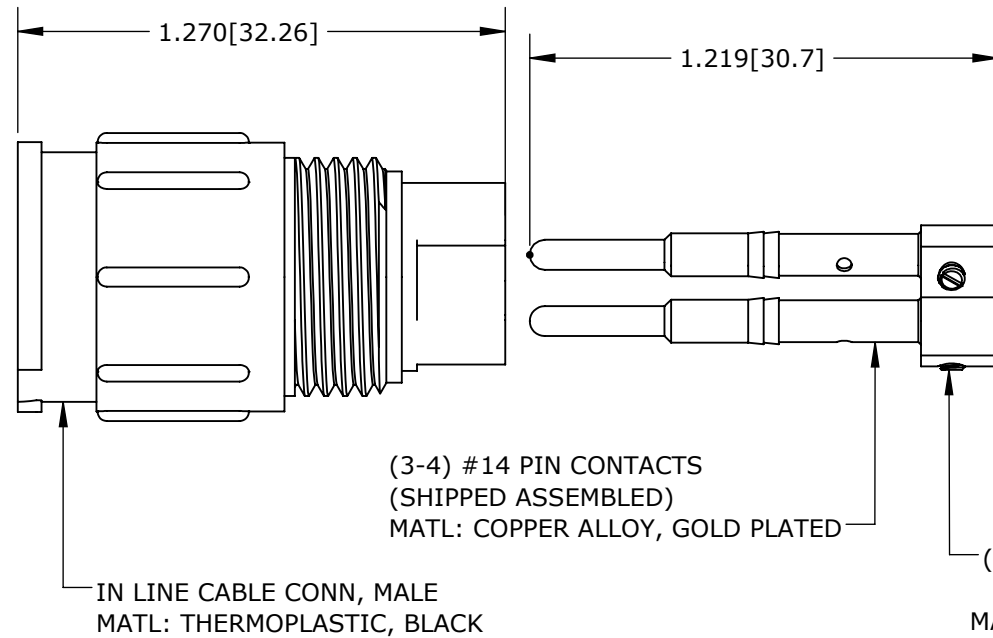

WIRING END VIEW (3 POS)
WITHOUT REAR END HARDWARE

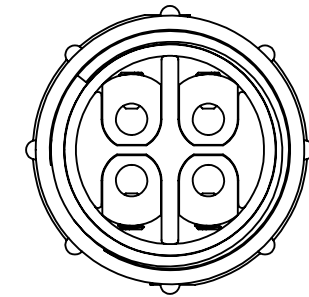

WIRING END VIEW (4 POS)
WITHOUT REAR END HARDWARE

CUSTOMER APPROVAL

THIS DOCUMENT CONTAINS CONFIDENTIAL INFORMATION PROPRIETARY TO CONXALL CORPORATION. ANY REPRODUCTION, DISCLOSURE, OR USE OF THIS DOCUMENT /INFORMATION IS EXPRESSLY PROHIBITED UNLESS AUTHORIZED IN WRITING BY CONXALL CORPORATION.

APPROVED BY: _____
DATE: _____

(RoHS COMPLIANT)

0A	AM	02/18/22	FIRST DRAWN
REV.	INIT.	DATE	DESCRIPTION
	AM	02/18/22	ORIG. DRAWN BY: DATE: AM 02/18/22
ALL INFORMATION ILLUSTRATED IS THE PROPERTY OF "CONXALL CORPORATION". UNAUTHORIZED DUPLICATION OR DISTRIBUTION OF THIS DOCUMENT IS PROHIBITED.			 601 E. WILDWOOD VILLA PARK, IL 60181
ALL UNITS ARE IN FEET, INCHES, FRACTION OF INCHES AND DECIMALS. UNLESS OTHERWISE SPECIFIED TOLERANCES: 3 PLACE DECIMALS ±.005 ANGLES ±1° FRACTIONS ±1/16 - CRITICAL CHARACTERISTIC FLAG PER SPEC. XXXX			
APPROVED BY:		TITLE: CABLE TO CABLE CONNECTOR (3 - 4) #14 PIN CONTACTS	
SCALE: NTS		CUSTOMER: STANDARD PRODUCT	
SIZE: B		SHEET: 1 OF 1	
FILE: _____		PART NUMBER: W5Z85-XPG-P-3XX	
DIRECTORY: SLW		REV: 0A	

Mouser Electronics

Authorized Distributor

Click to View Pricing, Inventory, Delivery & Lifecycle Information:

Switchcraft:

[W5Z85-3PG-P-328](#) [W5Z85-3PG-P-330](#) [W5Z85-3PG-P-335](#) [W5Z85-4PG-P-328](#) [W5Z85-4PG-P-330](#) [W5Z85-4PG-P-335](#)