

### YASMEEN-50-M

~26° medium beam. Assembly with holder C (LEDiL HEKLA) and B (BJB and B+W). Black and white versions.

#### SPECIFICATION:

Dimensions	Ø 49.9 mm
Height	27.6 mm
Fastening	socket
ROHS compliant	yes ⓘ



#### MATERIALS:

Component	Type	Material	Colour	Finish
YASMEEN-50-M	Single lens	PMMA	clear	
YASMEEN-50-HLD2-C	Holder C	PC	black	
YASMEEN-50-HLD2-B	Holder B	PC	black	
YASMEEN-50-HLD2-C-WHT	Holder C	PC	white	
YASMEEN-50-HLD2-B-WHT	Holder B	PC	white	

### ORDERING INFORMATION:

Component	Qty in box	MOQ	MPQ	Box weight (kg)
C17235_YASMEEN-50-M	252	112	28	7.8
<b>Assembly</b>				
CP18745_YASMEEN-50-M-B2-WHT	252	112	28	9.3
CP18738_YASMEEN-50-M-C2-WHT	252	112	28	9.1
CP18731_YASMEEN-50-M-B2	252	112	28	9.3
CP18724_YASMEEN-50-M-C2	252	112	28	9.0

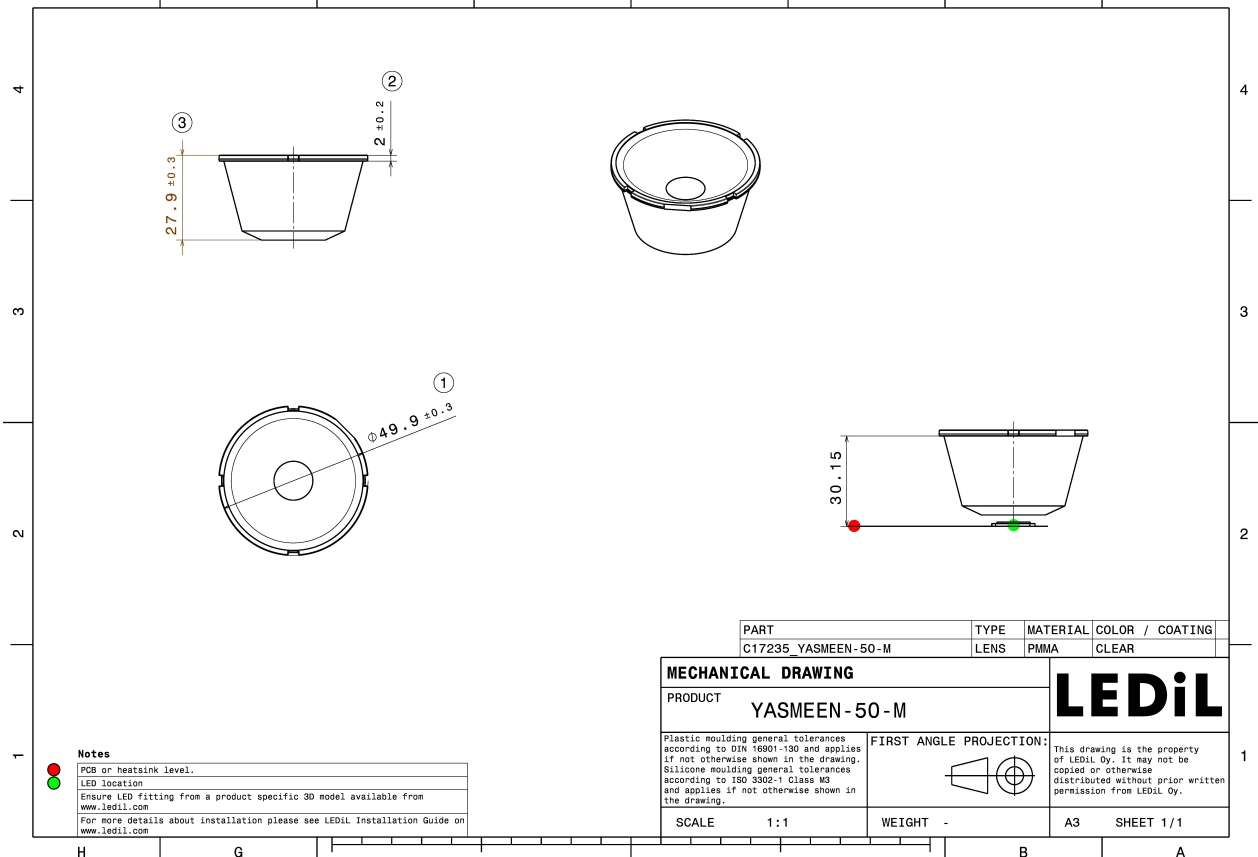
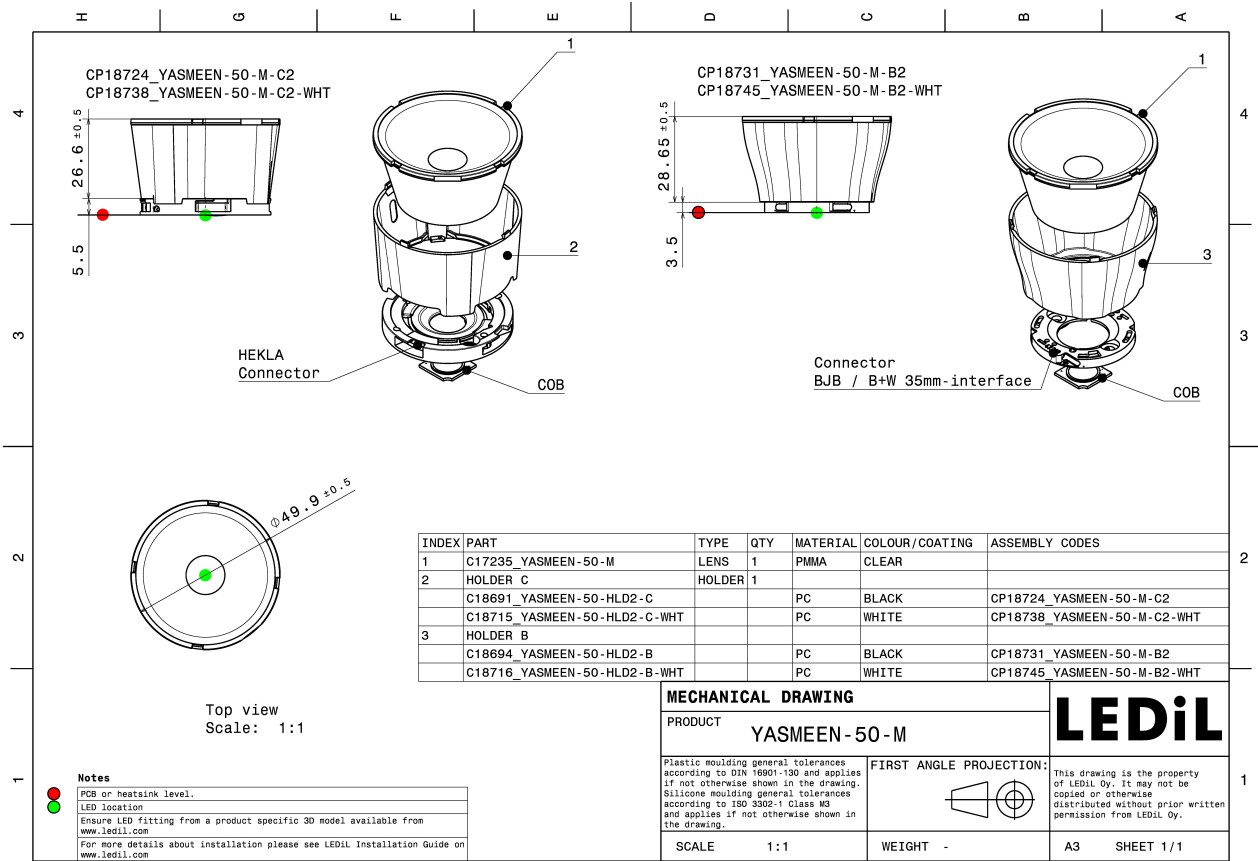

See also our general installation guide: [www.ledil.com/installation\\_guide](http://www.ledil.com/installation_guide)

### OPTICAL RESULTS (MEASURED):

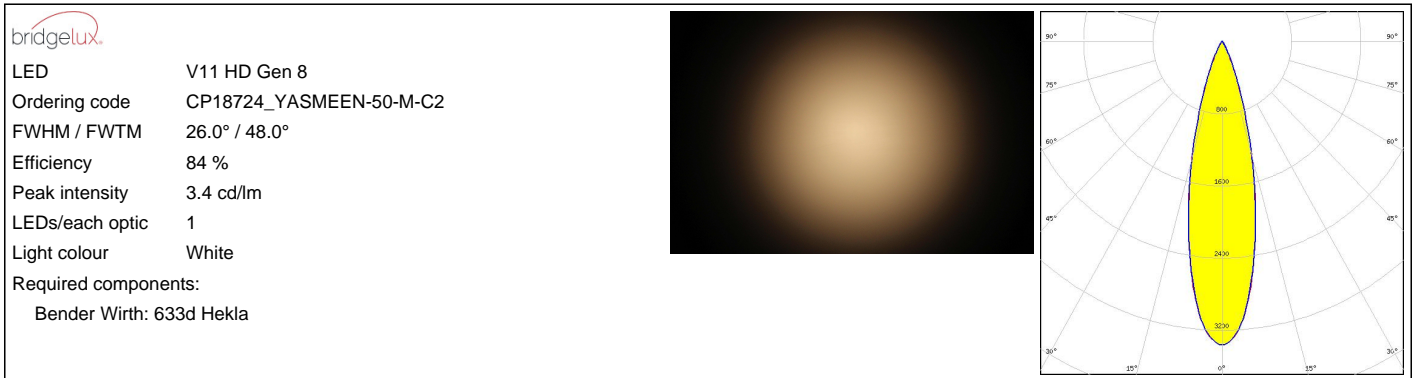
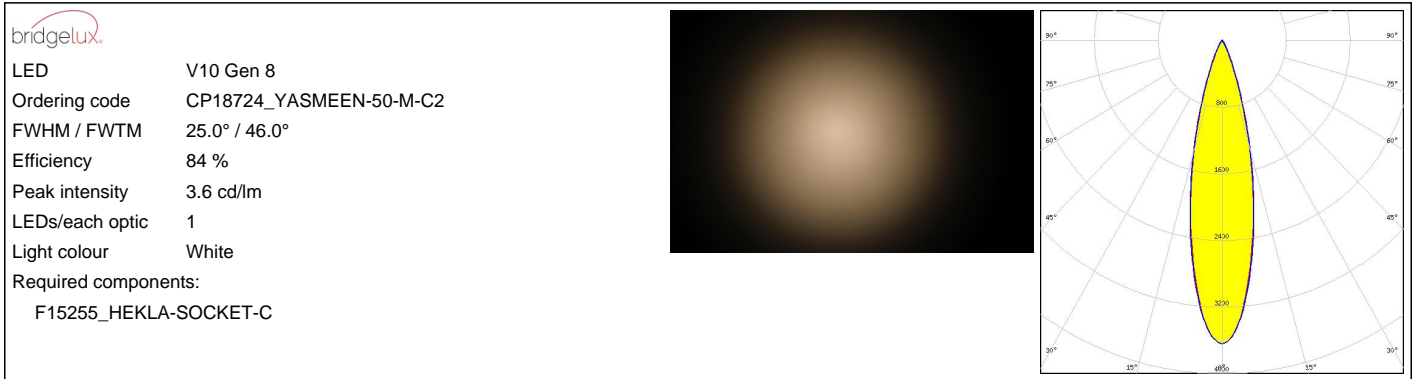

### OPTICAL RESULTS (MEASURED):

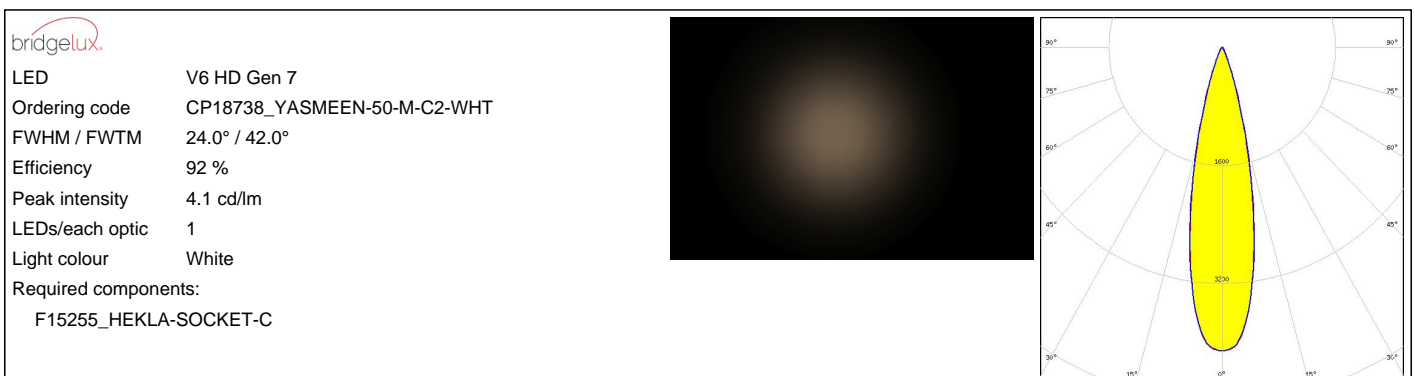
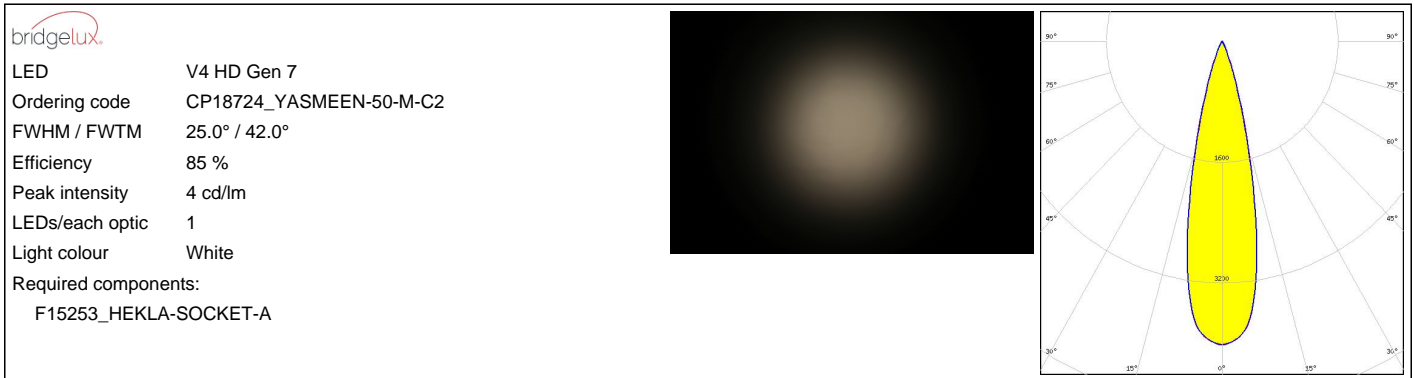
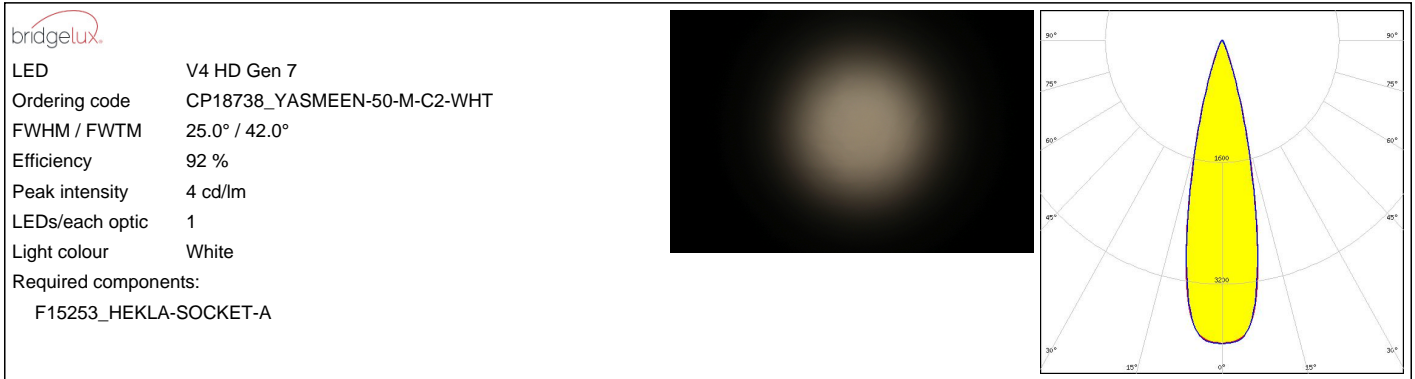

### OPTICAL RESULTS (MEASURED):

			
LED	V8 Gen 8		
Ordering code	CP18724_YASMEEN-50-M-C2		
FWHM / FWTM	24.0° / 45.0°		
Efficiency	85 %		
Peak intensity	4 cd/m		
LEDs/each optic	1		
Light colour	White		
Required components:			
F15253_HEKLA-SOCKET-A			

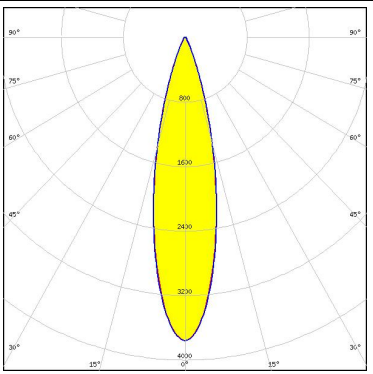
			
LED	VERO10		
Ordering code	CP18738_YASMEEN-50-M-C2-WHT		
FWHM / FWTM	24.0° / 46.0°		
Efficiency	91 %		
Peak intensity	3.8 cd/m		
LEDs/each optic	1		
Light colour	White		
Required components:			
F15616_HEKLA-SOCKET-F			

			
LED	VERO10		
Ordering code	CP18724_YASMEEN-50-M-C2		
FWHM / FWTM	24.5° / 46.0°		
Efficiency	84 %		
Peak intensity	3.8 cd/m		
LEDs/each optic	1		
Light colour	White		
Required components:			
F15616_HEKLA-SOCKET-F			

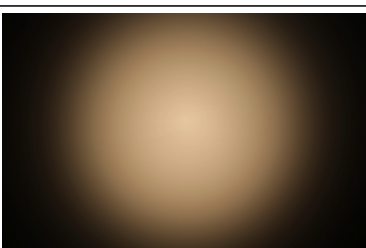
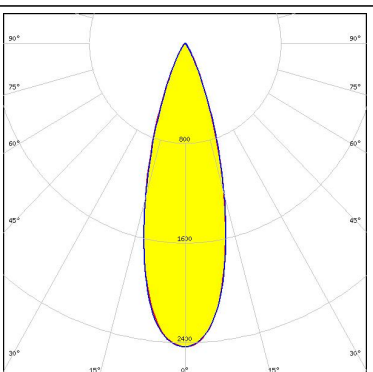
			
LED	Vesta DTW 13mm (21W)		
Ordering code	CP18724_YASMEEN-50-M-C2		
FWHM / FWTM	31.0° / 54.0°		
Efficiency	80 %		
Peak intensity	2.4 cd/m		
LEDs/each optic	1		
Light colour	White		
Required components:			
Bender Wirth: 632b Hekla XL			

### OPTICAL RESULTS (MEASURED):

bridgelux

LED Vesta DTW 15mm (33W)  
 Ordering code CP18724\_YASMEEN-50-M-C2  
 FWHM / FWTM 33.0° / 57.0°  
 Efficiency 79 %  
 Peak intensity 2.2 cd/lm  
 LEDs/each optic 1  
 Light colour White  
 Required components:  
 Bender Wirth: 632b Hekla XL

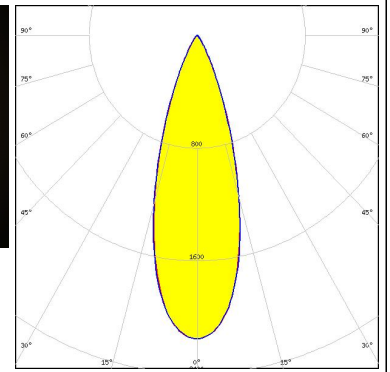
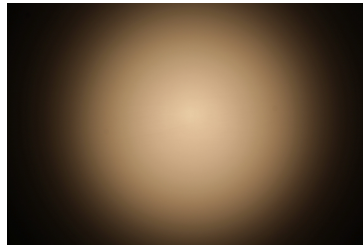

bridgelux

LED Vesta DTW 15mm (33W)  
 Ordering code CP18738\_YASMEEN-50-M-C2-WHT  
 FWHM / FWTM 33.0° / 59.0°  
 Efficiency 89 %  
 Peak intensity 2.1 cd/lm  
 LEDs/each optic 1  
 Light colour White  
 Required components:  
 Bender Wirth: 632b Hekla XL

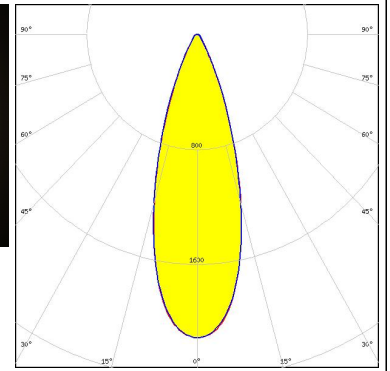

bridgelux

LED Vesta DTW 9mm (4W/6W/12W)  
 Ordering code CP18724\_YASMEEN-50-M-C2  
 FWHM / FWTM 23.0° / 45.0°  
 Efficiency 84 %  
 Peak intensity 4 cd/lm  
 LEDs/each optic 1  
 Light colour White  
 Required components:  
 Bender Wirth: 652b Hekla

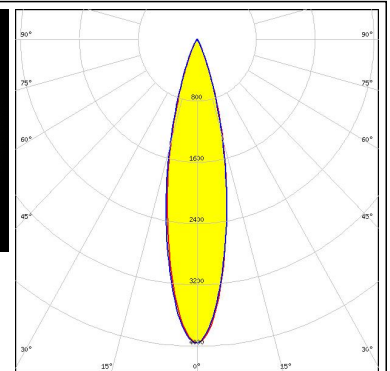
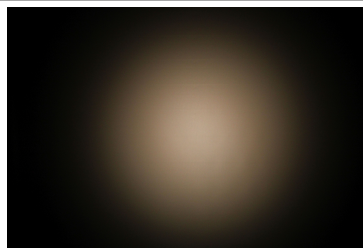

### CITIZEN

LED CLL02x/CLU02x (LES10)  
 Ordering code CP18724\_YASMEEN-50-M-C2  
 FWHM / FWTM 24.0° / 46.0°  
 Efficiency 84 %  
 Peak intensity 3.7 cd/lm  
 LEDs/each optic 1  
 Light colour White  
 Required components:  
 F17435\_HEKLA-G2-C

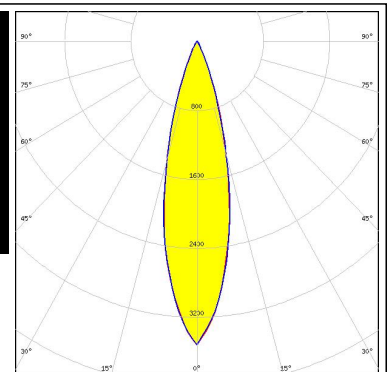
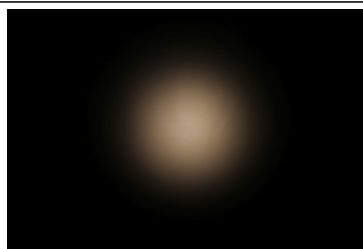

### OPTICAL RESULTS (MEASURED):

#### CITIZEN

LED CLL02x/CLU02x (LES10)  
 Ordering code CP18738\_YASMEEN-50-M-C2-WHT  
 FWHM / FWTM 25.0° / 46.0°  
 Efficiency 91 %  
 Peak intensity 3.7 cd/lm  
 LEDs/each optic 1  
 Light colour White  
 Required components:  
 F17435\_HEKLA-G2-C

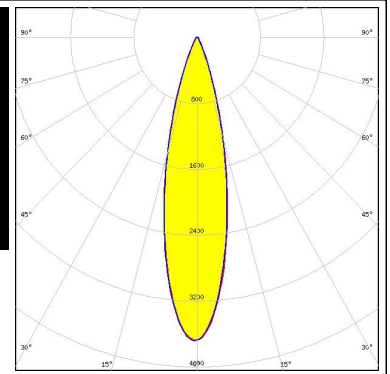

#### CITIZEN

LED CLU700/701/702/703  
 Ordering code CP18724\_YASMEEN-50-M-C2  
 FWHM / FWTM 24.0° / 43.0°  
 Efficiency 85 %  
 Peak intensity 4 cd/lm  
 LEDs/each optic 1  
 Light colour White  
 Required components:  
 F17435\_HEKLA-G2-C

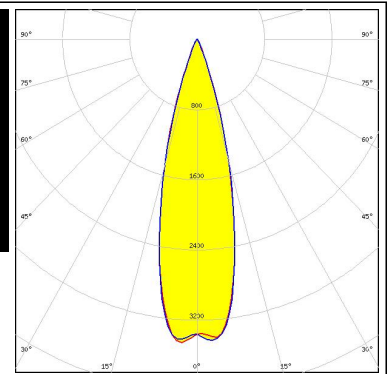
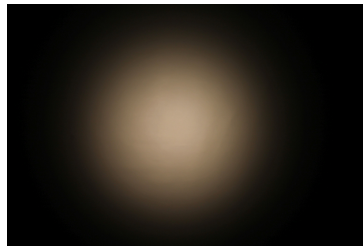

#### CITIZEN

LED CLU700/701/702/703  
 Ordering code CP18738\_YASMEEN-50-M-C2-WHT  
 FWHM / FWTM 24.0° / 42.0°  
 Efficiency 92 %  
 Peak intensity 4.1 cd/lm  
 LEDs/each optic 1  
 Light colour White  
 Required components:  
 F17435\_HEKLA-G2-C

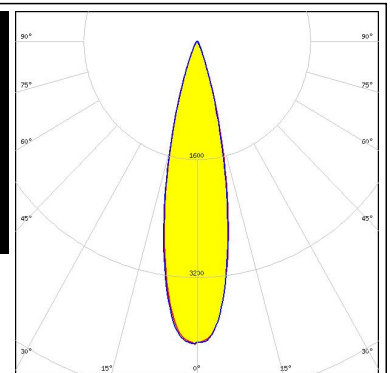
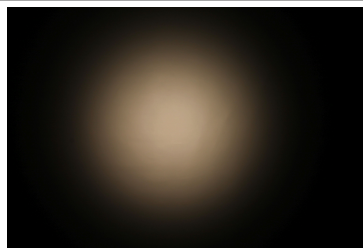

#### CITIZEN

LED CLU7A2/7A3  
 Ordering code CP18724\_YASMEEN-50-M-C2  
 FWHM / FWTM 25.0° / 42.0°  
 Efficiency 85 %  
 Peak intensity 4 cd/lm  
 LEDs/each optic 1  
 Light colour White  
 Required components:  
 F17435\_HEKLA-G2-C

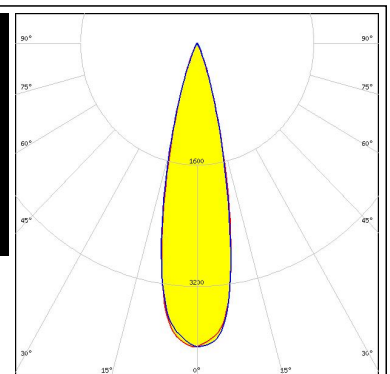



### OPTICAL RESULTS (MEASURED):

#### CITIZEN

LED CLU7A2/7A3  
 Ordering code CP18738\_YASMEEN-50-M-C2-WHT  
 FWHM / FWTM 25.0° / 41.5°  
 Efficiency 92 %  
 Peak intensity 4 cd/lm  
 LEDs/each optic 1  
 Light colour White  
 Required components:  
 F17435\_HEKLA-G2-C

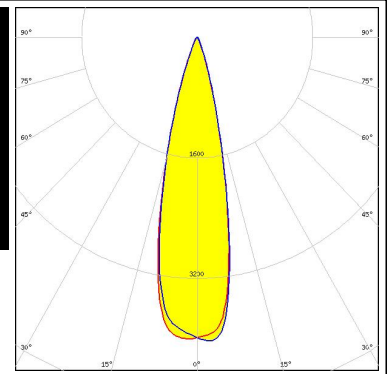

#### CITIZEN

LED CLU7B2  
 Ordering code CP18738\_YASMEEN-50-M-C2-WHT  
 FWHM / FWTM 26.0° / 42.0°  
 Efficiency 92 %  
 Peak intensity 3.8 cd/lm  
 LEDs/each optic 1  
 Light colour White  
 Required components:  
 F17435\_HEKLA-G2-C

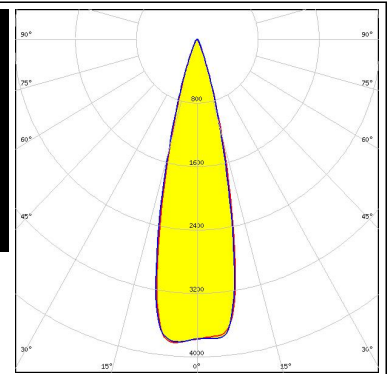
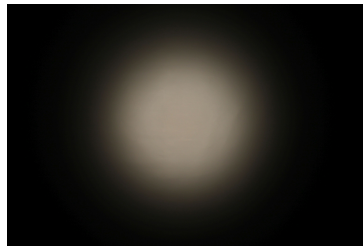

#### CITIZEN

LED CLU7B2  
 Ordering code CP18724\_YASMEEN-50-M-C2  
 FWHM / FWTM 25.0° / 42.0°  
 Efficiency 85 %  
 Peak intensity 3.8 cd/lm  
 LEDs/each optic 1  
 Light colour White  
 Required components:  
 F17435\_HEKLA-G2-C

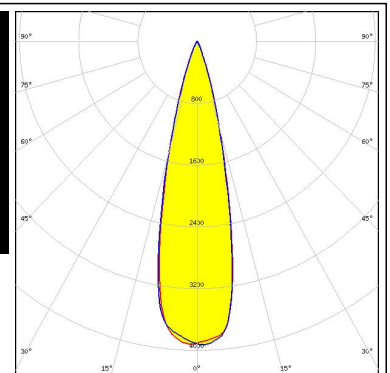
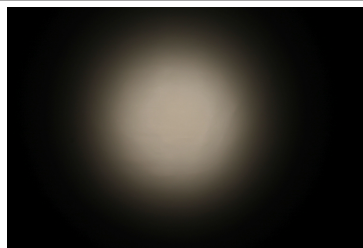

LED CMA1516  
 Ordering code CP18724\_YASMEEN-50-M-C2  
 FWHM / FWTM 24.0° / 45.0°  
 Efficiency 84 %  
 Peak intensity 3.9 cd/lm  
 LEDs/each optic 1  
 Light colour White  
 Required components:  
 F17436\_HEKLA-G2-D

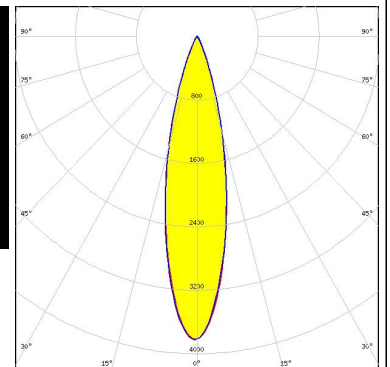
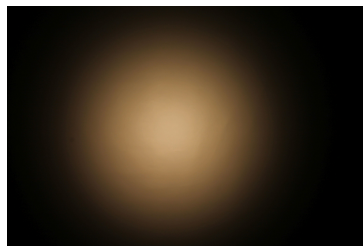

### OPTICAL RESULTS (MEASURED):



**LED** CMA1516  
**Ordering code** CP18738\_YASMEEN-50-M-C2-WHT  
**FWHM / FWTM** 24.0° / 45.0°  
**Efficiency** 91 %  
**Peak intensity** 3.9 cd/lm  
**LEDs/each optic** 1  
**Light colour** White  
**Required components:**  
 F17436\_HEKLA-G2-D

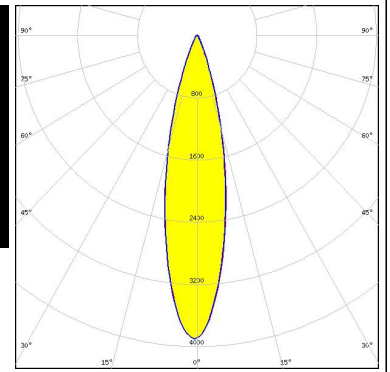

**LED** CMT14xx  
**Ordering code** CP18724\_YASMEEN-50-M-C2  
**FWHM / FWTM** 24.0° / 46.0°  
**Efficiency** 84 %  
**Peak intensity** 3.7 cd/lm  
**LEDs/each optic** 1  
**Light colour** White  
**Required components:**  
 F17435\_HEKLA-G2-C

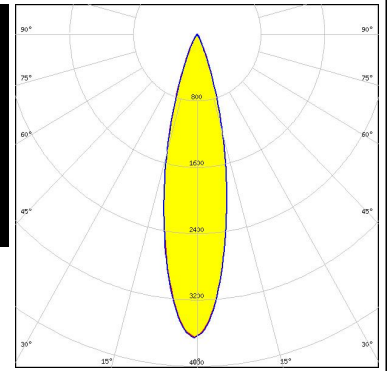

**LED** CMT14xx  
**Ordering code** CP18738\_YASMEEN-50-M-C2-WHT  
**FWHM / FWTM** 24.0° / 46.0°  
**Efficiency** 91 %  
**Peak intensity** 3.7 cd/lm  
**LEDs/each optic** 1  
**Light colour** White  
**Required components:**  
 F17435\_HEKLA-G2-C

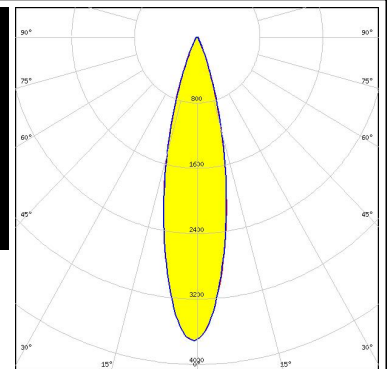
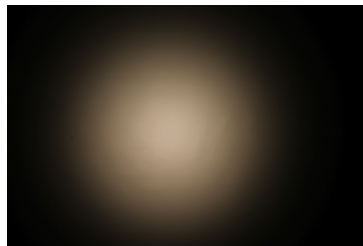

**LED** CMU10xx  
**Ordering code** CP18724\_YASMEEN-50-M-C2  
**FWHM / FWTM** 25.0° / 47.0°  
**Efficiency** 83 %  
**Peak intensity** 3.5 cd/lm  
**LEDs/each optic** 1  
**Light colour** White  
**Required components:**  
 F17435\_HEKLA-G2-C

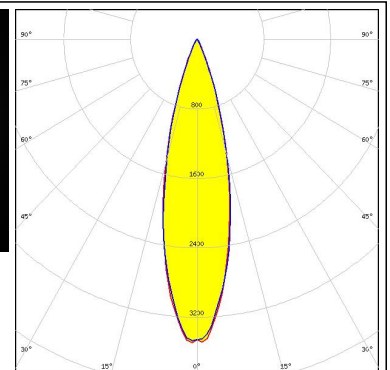
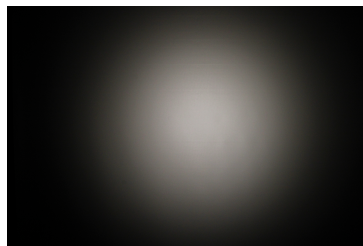

### OPTICAL RESULTS (MEASURED):



**LED** CXA/B 13xx  
**Ordering code** CP18724\_YASMEEN-50-M-C2  
**FWHM / FWTM** 25.0° / 43.0°  
**Efficiency** 86 %  
**Peak intensity** 4 cd/lm  
**LEDs/each optic** 1  
**Light colour** White  
**Required components:**  
 F17439\_HEKLA-G2-J

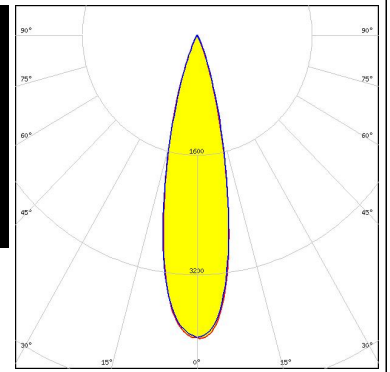
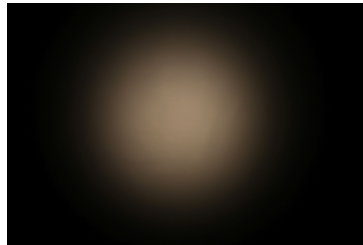

**LED** CXA/B 13xx  
**Ordering code** CP18738\_YASMEEN-50-M-C2-WHT  
**FWHM / FWTM** 25.0° / 43.0°  
**Efficiency** 93 %  
**Peak intensity** 4 cd/lm  
**LEDs/each optic** 1  
**Light colour** White  
**Required components:**  
 F17439\_HEKLA-G2-J

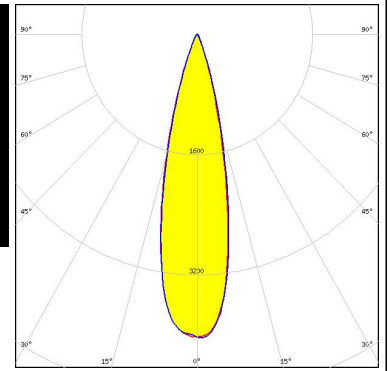

**LED** CXA/B 15xx  
**Ordering code** CP18724\_YASMEEN-50-M-C2  
**FWHM / FWTM** 24.0° / 45.0°  
**Efficiency** 84 %  
**Peak intensity** 3.9 cd/lm  
**LEDs/each optic** 1  
**Light colour** White  
**Required components:**  
 F17436\_HEKLA-G2-D

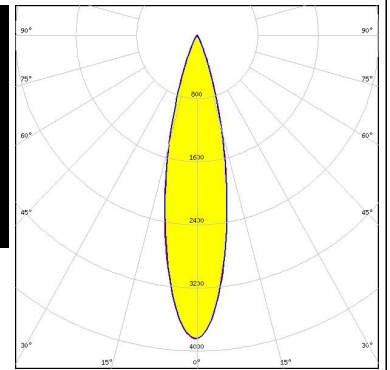

**LED** CXA/B 15xx  
**Ordering code** CP18738\_YASMEEN-50-M-C2-WHT  
**FWHM / FWTM** 24.0° / 45.0°  
**Efficiency** 92 %  
**Peak intensity** 3.9 cd/lm  
**LEDs/each optic** 1  
**Light colour** White  
**Required components:**  
 F17436\_HEKLA-G2-D

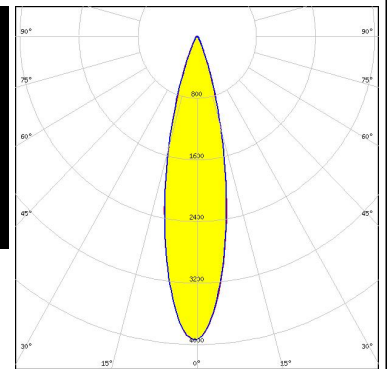
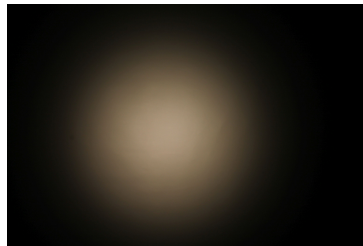

### OPTICAL RESULTS (MEASURED):



### OPTICAL RESULTS (MEASURED):

#### LUMILEDS

LED LUXEON CoB 1204HD  
 Ordering code CP18724\_YASMEEN-50-M-C2  
 FWHM / FWTM 23.0° / 45.0°  
 Efficiency 83 %  
 Peak intensity 4 cd/lm  
 LEDs/each optic 1  
 Light colour White  
 Required components:  
 F17437\_HEKLA-G2-H

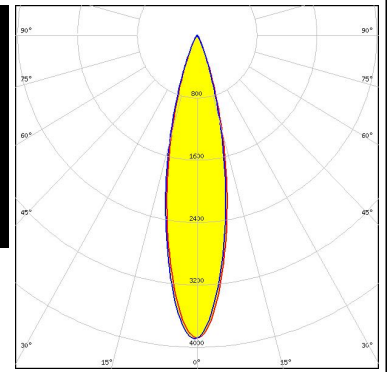
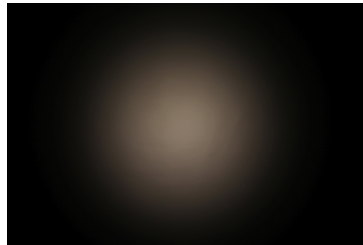

#### LUMILEDS

LED LUXEON CoB M02/M03  
 Ordering code CP18724\_YASMEEN-50-M-C2  
 FWHM / FWTM 24.0° / 45.0°  
 Efficiency 84 %  
 Peak intensity 3.9 cd/lm  
 LEDs/each optic 1  
 Light colour White  
 Required components:  
 F17436\_HEKLA-G2-D

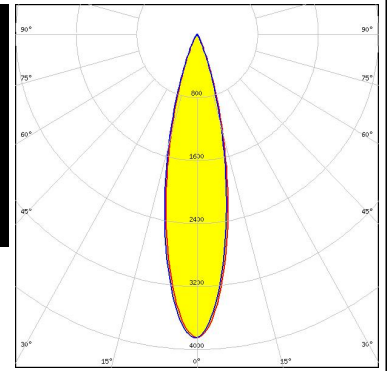

#### LUMILEDS

LED LUXEON CoB M02/M03  
 Ordering code CP18738\_YASMEEN-50-M-C2-WHT  
 FWHM / FWTM 24.0° / 45.0°  
 Efficiency 92 %  
 Peak intensity 3.9 cd/lm  
 LEDs/each optic 1  
 Light colour White  
 Required components:  
 F17436\_HEKLA-G2-D

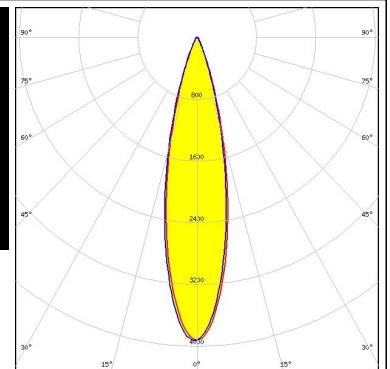
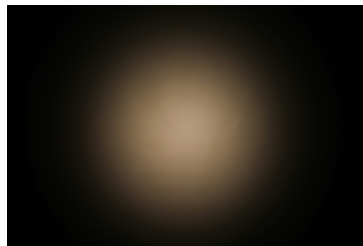

#### LUMILEDS

LED LUXEON CoB S01  
 Ordering code CP18724\_YASMEEN-50-M-C2  
 FWHM / FWTM 24.0° / 42.0°  
 Efficiency 85 %  
 Peak intensity 4.1 cd/lm  
 LEDs/each optic 1  
 Light colour White  
 Required components:  
 F17439\_HEKLA-G2-J

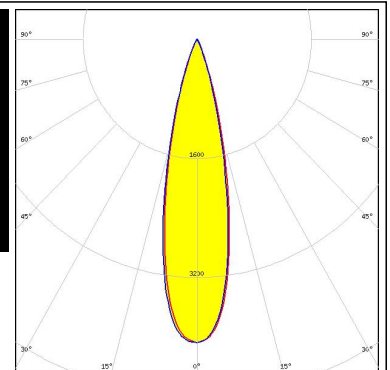
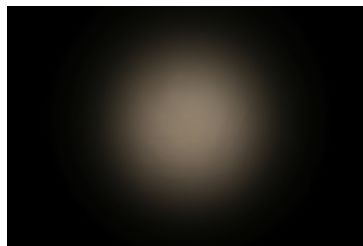

### OPTICAL RESULTS (MEASURED):



**LED** LUXEON CoB S01  
**Ordering code** CP18738\_YASMEEN-50-M-C2-WHT  
**FWHM / FWTM** 24.0° / 42.0°  
**Efficiency** 92 %  
**Peak intensity** 4.1 cd/lm  
**LEDs/each optic** 1  
**Light colour** White  
**Required components:**  
 F17439\_HEKLA-G2-J

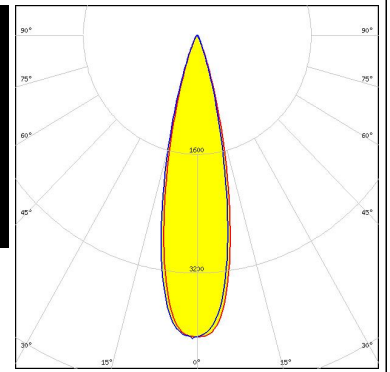

**LED** CXM-3  
**Ordering code** CP18738\_YASMEEN-50-M-C2-WHT  
**FWHM / FWTM** 25.0° / 41.0°  
**Efficiency** 92 %  
**Peak intensity** 3.9 cd/lm  
**LEDs/each optic** 1  
**Light colour** White  
**Required components:**  
 F17435\_HEKLA-G2-C

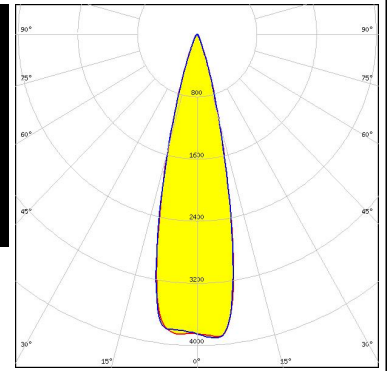

**LED** CXM-3  
**Ordering code** CP18724\_YASMEEN-50-M-C2  
**FWHM / FWTM** 25.0° / 42.0°  
**Efficiency** 85 %  
**Peak intensity** 4 cd/lm  
**LEDs/each optic** 1  
**Light colour** White  
**Required components:**  
 F17435\_HEKLA-G2-C

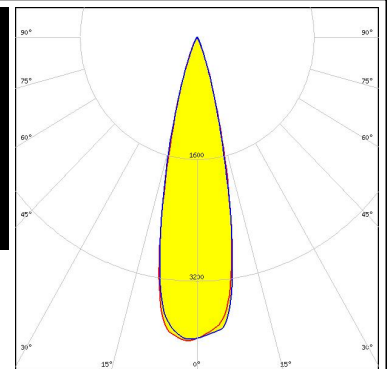
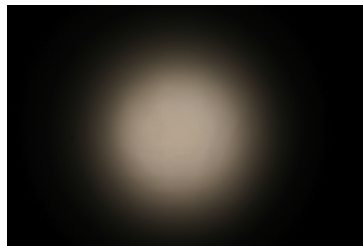

**LED** CXM-4  
**Ordering code** CP18724\_YASMEEN-50-M-C2  
**FWHM / FWTM** 24.0° / 42.0°  
**Efficiency** 85 %  
**Peak intensity** 4 cd/lm  
**LEDs/each optic** 1  
**Light colour** White  
**Required components:**  
 F17435\_HEKLA-G2-C

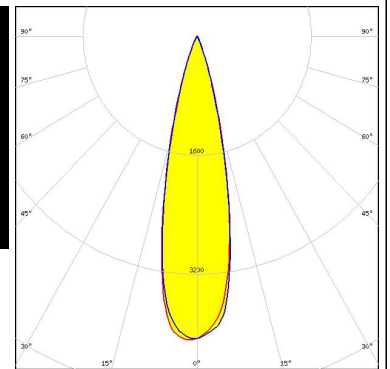
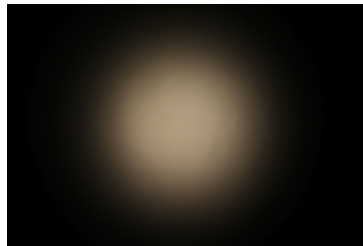

### OPTICAL RESULTS (MEASURED):



**LED** CXM-4  
**Ordering code** CP18738\_YASMEEN-50-M-C2-WHT  
**FWHM / FWTM** 25.0° / 42.0°  
**Efficiency** 92 %  
**Peak intensity** 4 cd/lm  
**LEDs/each optic** 1  
**Light colour** White  
**Required components:**  
 F17435\_HEKLA-G2-C

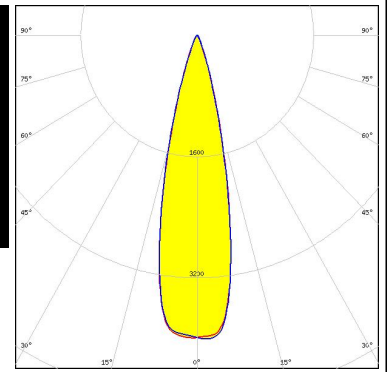

**LED** COB L-Type (LES 9)  
**Ordering code** CP18738\_YASMEEN-50-M-C2-WHT  
**FWHM / FWTM** 24.0° / 44.0°  
**Efficiency** 91 %  
**Peak intensity** 3.9 cd/lm  
**LEDs/each optic** 1  
**Light colour** White  
**Required components:**  
 F17437\_HEKLA-G2-H

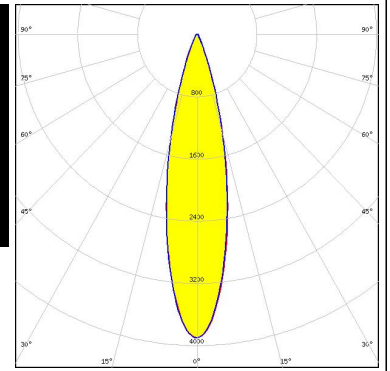

**LED** COB S-Type (LES 7)  
**Ordering code** CP18738\_YASMEEN-50-M-C2-WHT  
**FWHM / FWTM** 25.0° / 44.0°  
**Efficiency** 91 %  
**Peak intensity** 4 cd/lm  
**LEDs/each optic** 1  
**Light colour** White  
**Required components:**  
 F15848\_HEKLA-SOCKET-G

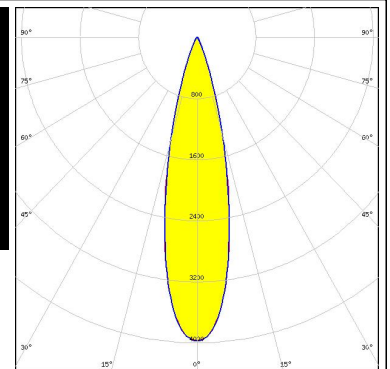
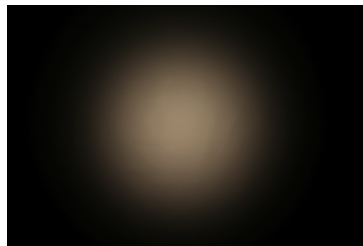

**LED** COB S-Type (LES 7)  
**Ordering code** CP18724\_YASMEEN-50-M-C2  
**FWHM / FWTM** 24.0° / 44.0°  
**Efficiency** 85 %  
**Peak intensity** 4 cd/lm  
**LEDs/each optic** 1  
**Light colour** White  
**Required components:**  
 F15848\_HEKLA-SOCKET-G

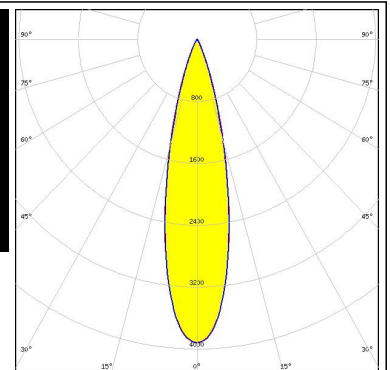
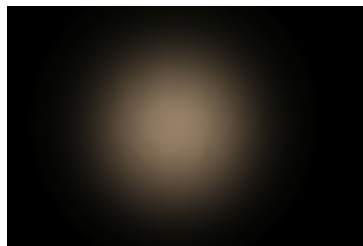

### OPTICAL RESULTS (MEASURED):

#### PHILIPS

LED Fortimo SLM L09 CoB  
 Ordering code CP18724\_YASMEEN-50-M-C2  
 FWHM / FWTM 23.0° / 45.0°  
 Efficiency 83 %  
 Peak intensity 3.9 cd/lm  
 LEDs/each optic 1  
 Light colour White  
 Required components:  
 F17437\_HEKLA-G2-H

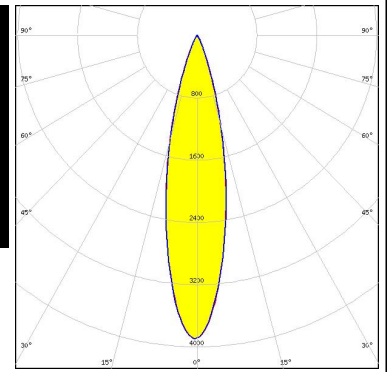
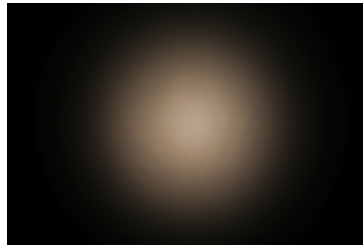

#### PHILIPS

LED Fortimo SLM L09 CoB  
 Ordering code CP18738\_YASMEEN-50-M-C2-WHT  
 FWHM / FWTM 23.0° / 44.0°  
 Efficiency 91 %  
 Peak intensity 4 cd/lm  
 LEDs/each optic 1  
 Light colour White  
 Required components:  
 F17437\_HEKLA-G2-H

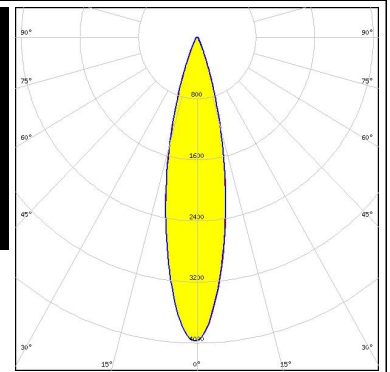
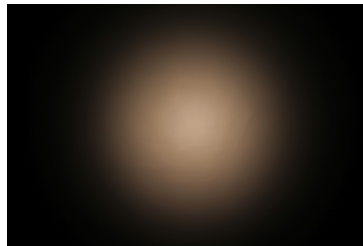

#### SAMSUNG

LED LC003D / LC006D / LC009D / LC013D  
 Ordering code CP18724\_YASMEEN-50-M-C2  
 FWHM / FWTM 24.0° / 46.0°  
 Efficiency 84 %  
 Peak intensity 3.7 cd/lm  
 LEDs/each optic 1  
 Light colour White  
 Required components:  
 F17435\_HEKLA-G2-C

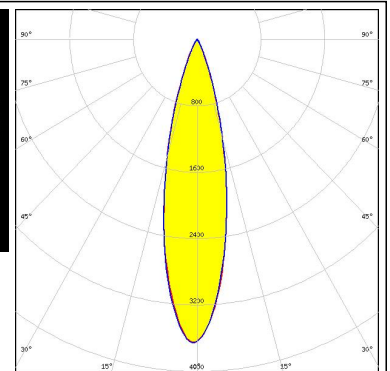
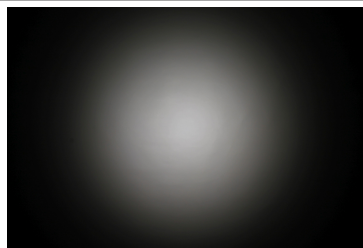

#### SAMSUNG

LED LC003D / LC006D / LC009D / LC013D  
 Ordering code CP18738\_YASMEEN-50-M-C2-WHT  
 FWHM / FWTM 24.0° / 46.0°  
 Efficiency 91 %  
 Peak intensity 3.7 cd/lm  
 LEDs/each optic 1  
 Light colour White  
 Required components:  
 F17435\_HEKLA-G2-C

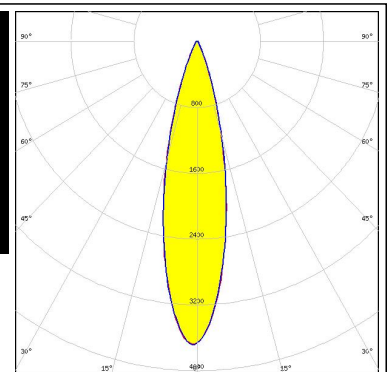
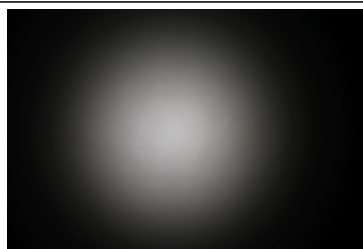



### OPTICAL RESULTS (MEASURED):

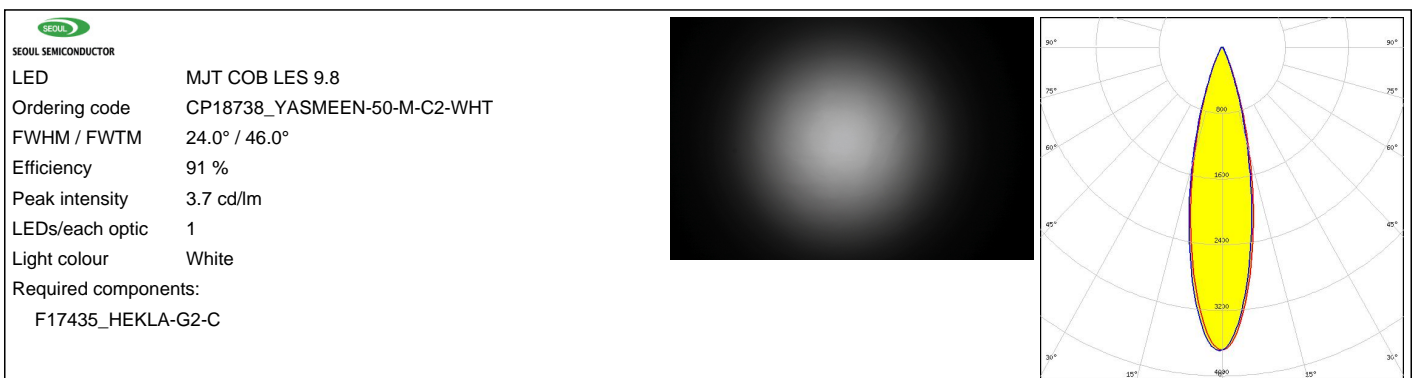
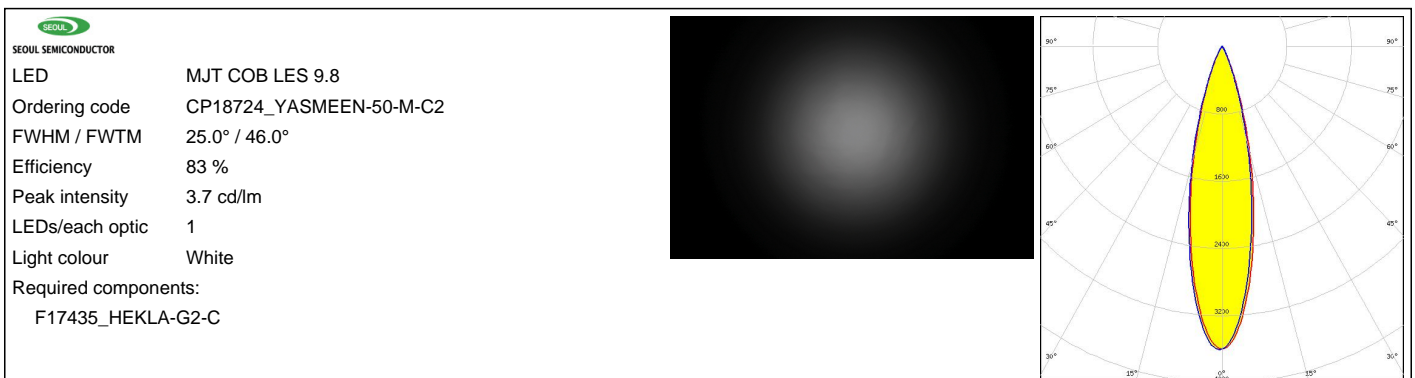
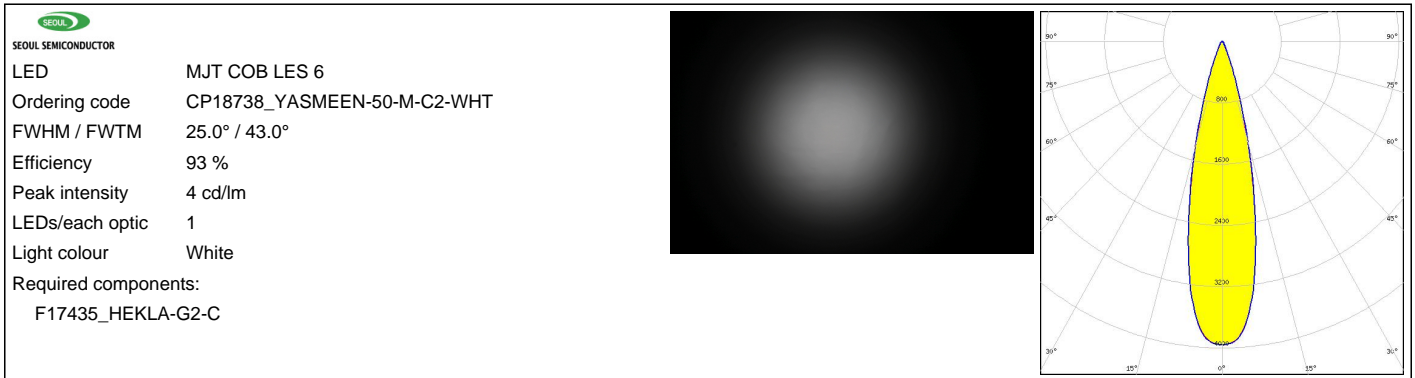
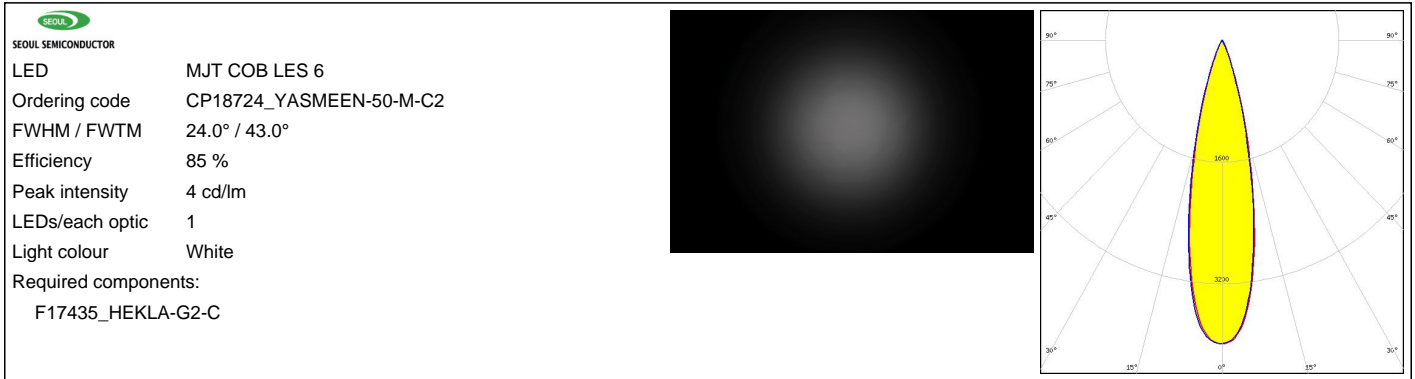

### OPTICAL RESULTS (SIMULATED):



LED Vero SE 13  
Ordering code CP18724\_YASMEEN-50-M-C2  
FWHM / FWTM 26.0° / 48.0°  
Efficiency 73 %  
Peak intensity 2.9 cd/lm  
LEDs/each optic 1  
Light colour White  
Required components:  
C16142\_HEKLA-SOCKET-K

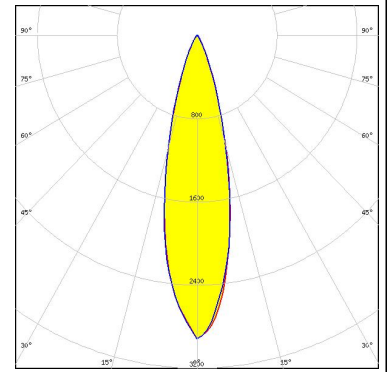

### CITIZEN

LED CLU712/713  
Ordering code CP18724\_YASMEEN-50-M-C2  
FWHM / FWTM 26.0° / 46.0°  
Efficiency 83 %  
Peak intensity 3.6 cd/lm  
LEDs/each optic 1  
Light colour White  
Required components:  
F17438\_HEKLA-G2-I

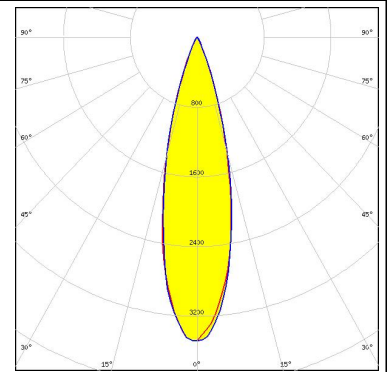

LED CHA0304  
Ordering code CP18724\_YASMEEN-50-M-C2  
FWHM / FWTM 30.0° / 44.0°  
Efficiency 85 %  
Peak intensity 3.4 cd/lm  
LEDs/each optic 1  
Light colour White  
Required components:  
F17435\_HEKLA-G2-C

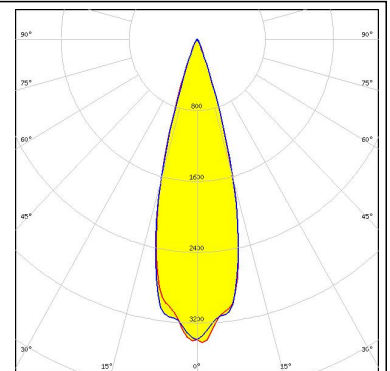

LED CHA0410  
Ordering code CP18724\_YASMEEN-50-M-C2  
FWHM / FWTM 28.0° / 44.0°  
Efficiency 85 %  
Peak intensity 3.6 cd/lm  
LEDs/each optic 1  
Light colour White  
Required components:  
F17435\_HEKLA-G2-C

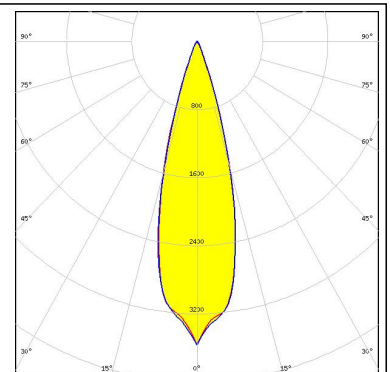

### OPTICAL RESULTS (SIMULATED):



LED: CHA0612  
Ordering code: CP18724\_YASMEEN-50-M-C2  
FWHM / FWTM: 28.0° / 44.0°  
Efficiency: 84 %  
Peak intensity: 3.4 cd/lm  
LEDs/each optic: 1  
Light colour: White  
Required components:  
F17435\_HEKLA-G2-C

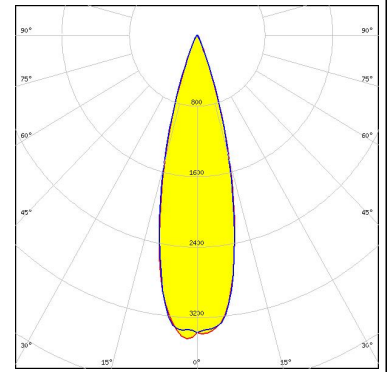

### TRIDONIC

LED: SLE G7 LES13  
Ordering code: CP18724\_YASMEEN-50-M-C2  
FWHM / FWTM: 30.0° / 52.0°  
Efficiency: 80 %  
Peak intensity: 2.7 cd/lm  
LEDs/each optic: 1  
Light colour: White  
Required components:  
F17438\_HEKLA-G2-I

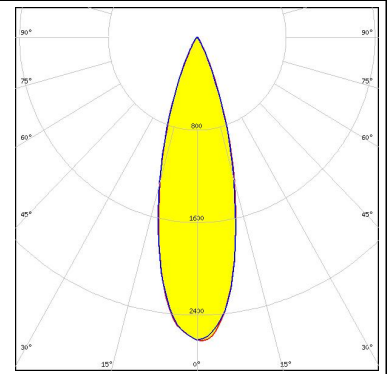

### GENERAL INFORMATION:

NOTE: The typical beam angle will be changed by different color, chip size and chip position tolerance. The typical total beam angle is the full angle measured where the luminous intensity is half of the peak value.

Due to use of high power COB's with this product, special attention to proper thermal design is highly recommended. LEDiL has no liability for direct, indirect or consecutive damages arising from the LEDiL products being used outside of the recommended temperature range.

### MATERIALS:

As part of our continuous research and improvement processes, and to ensure the best possible quality and availability of our products, LEDiL reserves the right to change material grades without notice.

### PRODUCT DATA USER AGREEMENT AND DISCLAIMER:

The measured data in the provided downloadable LEDiL Product Datasheets and Mechanical 2D-Drawings is rounded and provided as reference for planning. LEDiL Oy's optical specifications have been verified by conducting performance testing of the products in accordance with the company's quality system. The reported data are averaged results of multiple measurements with typical variation. LEDiL Oy reserves the right to without prior notification make changes and improvements to its products.

LEDiL Oy assumes neither warranty, nor guarantee nor any other liability of any kind for the contents and correctness of the provided data. The provided data has been generated with highest diligence but the provided data may in reality not represent the complete possible variation range of all intrinsic parameters. Therefore, in certain cases a deviation from the provided data could occur.

LEDiL Oy reserves the right to undertake technical changes of its products without further notification which could lead to changes in the provided data. LEDiL Oy assumes no liability of any kind for the possible deviation from any provided data or any other damage resulting from the usage of the provided data.

The user agrees to this disclaimer and user agreement with the download or usage of the provided files.

#### LEDiL Oy

Joensuunkatu 13  
FI-24240 SALO  
Finland

#### LEDiL Inc.

228 West Page Street  
Suite D  
Sycamore IL 60178  
USA

#### Ledil Optics Technology (Shenzhen) Co., Ltd.

# 405 , Block B  
Casic Motor Building  
Shenzhen 518057  
P.R.CHINA

#### Local sales and technical support

[www.ledil.com/  
where\\_to\\_buy](http://www.ledil.com/where_to_buy)

#### Shipping locations

Salo, Finland  
Hong Kong, China

#### Distribution Partners

[www.ledil.com/  
where\\_to\\_buy](http://www.ledil.com/where_to_buy)

# Mouser Electronics

Authorized Distributor

Click to View Pricing, Inventory, Delivery & Lifecycle Information:

Ledil:

[CP18724\\_YASMEEN-50-M-C2](#)