

## ASMT-Rx45-xxxxx

### 0.45-mm Leadframe-Based Surface Mount ChipLED

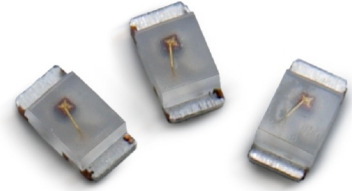

#### Description

The ultra-thin Broadcom<sup>®</sup> ASMT-Rx45 ChipLEDs were developed based on the industrial standard ChipLED 0603 platform, which requires less board space. These ChipLEDs provide a wide viewing angle of 130 degrees to improve visibility in bright sunlight.

In addition to the high brightness and compact size, the Broadcom ASMT-Rx45 ChipLEDs provide two significant advantages in the production environment: They can be easily soldered using the IR solder reflow process, and the package is qualified to a Joint Electron Device Engineering Council (JEDEC) moisture sensitive level (MSL) rating of 2a. For manufacturers, this rating means that these ChipLEDs can be kept in the open air (30°C, 60% relative humidity) for up to four weeks after being removed from their sealed package without the need to remove absorbed moisture.

The Broadcom ultra-thin Leadframe ChipLED is available in red, orange, yellow green, and amber colors. The ASMT-Rx45 series is ideal for use by lighting designers who develop backlighting for dashboards and entertainment consoles in automobiles, backlighting of industrial switches and buttons, and small pixel indoor signs.

#### Features

- Industrial 0603 platform – 1.6 mm × 0.8 mm × 0.45 mm
- Automotive qualified
- Super wide 145° viewing angle
- JEDEC MSL 2a
- Robust operating temperature from –40°C to +100°C
- Junction temperature  $T_J = 110^\circ\text{C}$
- Available in 4000 parts per reel
- RoHS and IR reflow compatible

#### Applications

- Interior automotive
  - Navigation backlighting
  - Audio panel backlighting
  - Push button backlighting
- Office automation, home appliances, and industrial equipment
  - Front panel backlighting
  - Push button backlighting
  - LCD backlighting
  - Switch backlighting
  - Navigation backlighting

**CAUTION!** ASMT-Rx45 LEDs are Class 1C ESD sensitive per JESD22-A114C.01. Observe appropriate precautions during handling and processing. Refer to Application Note AN-1142 for additional details.

## Package Dimensions

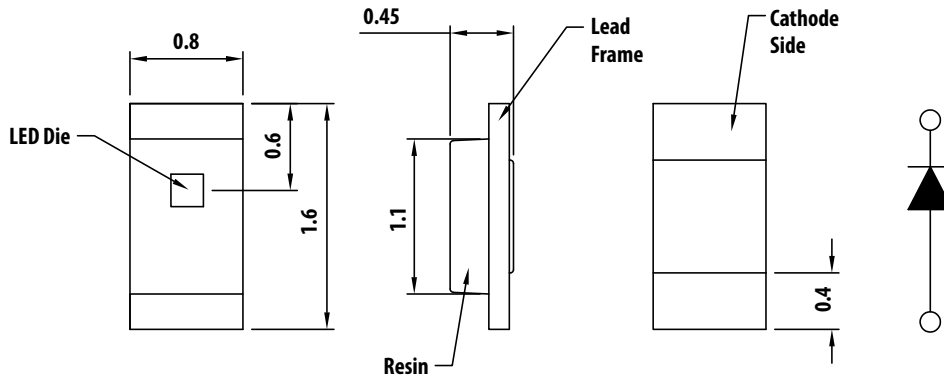

### NOTE:

1. All dimensions are in millimeters.
2. Tolerance is  $\pm 0.1$  mm unless otherwise specified.

## Device Selection Guide

Part Number	Min. $I_v$ (mcd)	Typ. $I_v$ (mcd)	Test Current (mA)	Colors	Dice Technology	Package Description
ASMT-RR45-AQ902	90.0	120.0	20	Red	AllnGaP	Untinted, Diffused
ASMT-RJ45-AQ502	71.5	130.0	20	Orange	AllnGaP	Untinted, Diffused
ASMT-RF45-AN002	28.0	60.0	20	Yellow Green	AllnGaP	Untinted, Diffused
ASMT-RF45-AN502	28.0	60.0	20	Yellow Green	AllnGaP	Untinted, Diffused
ASMT-RF45-AP4L2	45.0	60.0	20	Yellow Green	AllnGaP	Untinted, Diffused
ASMT-RA45-AP932	57.0	90.0	20	Amber	AllnGaP	Untinted, Diffused
ASMT-RA45-AQ3N2	71.5	90.0	20	Amber	AllnGaP	Untinted, Diffused
ASMT-RH45-AQ502	71.5	110.0	20	Red Orange	AllnGaP	Untinted, Diffused

### NOTE:

1. The luminous intensity,  $I_v$ , is measured at the peak of the spatial radiation pattern, which may not be aligned with the mechanical axis of the LED package.
2. Tolerance:  $\pm 15\%$ .

## Part Numbering System

A S M T - R X<sub>1</sub> 4 5 - X<sub>2</sub> X<sub>3</sub> X<sub>4</sub> X<sub>5</sub> X<sub>6</sub>

Code	Description	Option	
X <sub>1</sub>	LED Chip Color	A	Amber
		F	Yellow Green
		H	Red Orange
		J	Orange
		R	Red
X <sub>2</sub>	Dice Type	A	AllnGaP
X <sub>3</sub>	Minimum Intensity Bin Selection	Refer to Intensity Bin Select	
X <sub>4</sub>	Number of Intensity Bins		
X <sub>5</sub>	Color Bin Selection	Refer to Color Bin Select	
X <sub>6</sub>	Packaging Option	2	20-mA Test Current, Top Mount, 7-Inch Reel
		H	2-mA Test Current, Top Mount, 7-Inch Reel
		K	5-mA Test Current, Top Mount, 7-Inch Reel

## Absolute Maximum Ratings at $T_A = 25^\circ\text{C}$

Parameter	ASMT-Rx45	Units
DC Forward Current <sup>a</sup>	20	mA
Power Dissipation	48	mW
Reverse Voltage ( $I_R = 10 \mu\text{A}$ )	5	V
LED Junction Temperature	110	$^\circ\text{C}$
Operating Temperature Range	-40 to +100	$^\circ\text{C}$
Storage Temperature Range	-40 to +100	$^\circ\text{C}$

a. Applies when a single LED is illuminated.

## Electrical Characteristics at $T_A = 25^\circ\text{C}$

Part Number	Forward Voltage $V_F$ (Volts) <sup>a</sup> @ $I_F = 20 \text{ mA}$			Reverse Breakdown $V_R$ (Volts) @ $I_R = 10 \mu\text{A}$	Thermal Resistance $R_{\theta_{J-PIN}}$ ( $^\circ\text{C/W}$ )
	Min.	Typ.	Max.	Min.	Typ.
ASMT-Rx45-Axxxx	1.6	2.0	2.4	5	246

a.  $V_F$  tolerance:  $\pm 0.1\text{V}$ .

## Optical Characteristics at $T_A = 25^\circ\text{C}$

Part Number	Color	Peak Wavelength $\lambda_{\text{peak}}$ (nm)	Dominant Wavelength $\lambda_d^a$ (nm)	Viewing Angle $2\theta_{1/2}^b$ (Degrees)
		Typical	Typical	Typical
ASMT-RR45-Axxxx	Red	636	622	145
ASMT-RJ45-Axxxx	Orange	612	605	145
ASMT-RF45-Axxxx	Yellow Green	574	573	145
ASMT-RA45-Axxxx	Amber	593	591	145
ASMT-RH45-Axxxx	Red Orange	621	615	145

a. The dominant wavelength,  $\lambda_d$ , is derived from the CIE Chromaticity Diagram and represents the perceived color of the device.

b.  $\theta_{1/2}$  is the off-axis angle where the luminous intensity is  $\frac{1}{2}$  the peak intensity.

Figure 1: Relative Intensity vs. Wavelength

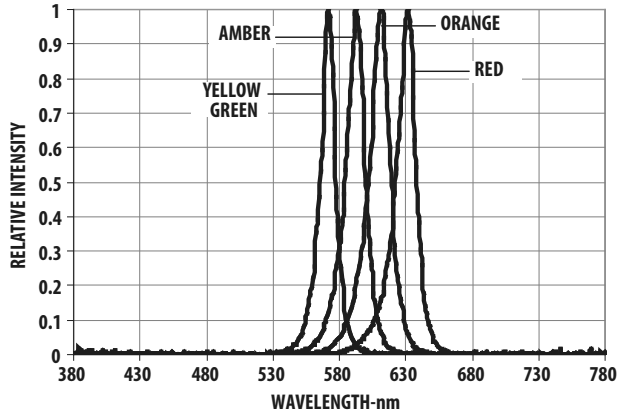

Figure 2: Forward Current vs. Forward Voltage

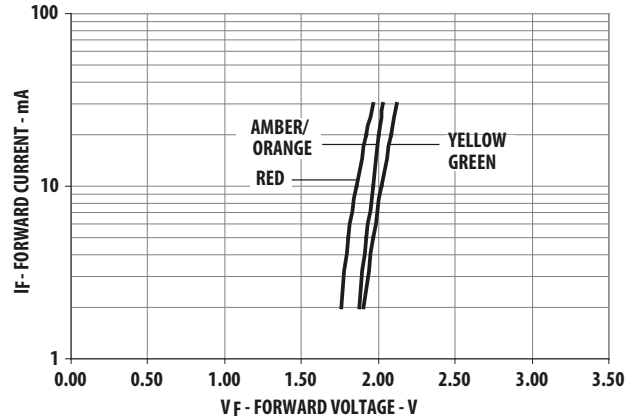

Figure 3: Luminous Intensity vs. Forward Current

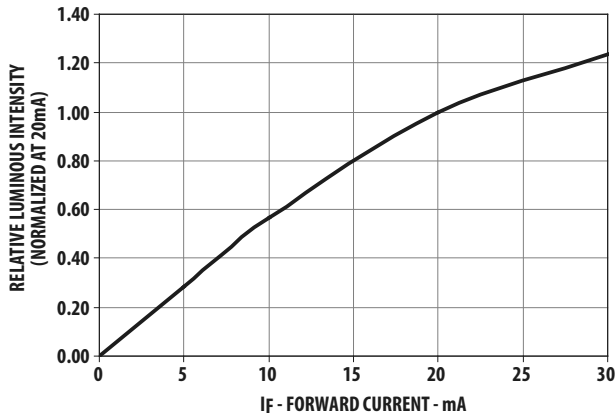

Figure 4: Maximum Forward Current vs. Ambient Temperature. Derated based on T<sub>JMAX</sub> = 110°C, R<sub>θJA</sub> = 465°C/W.

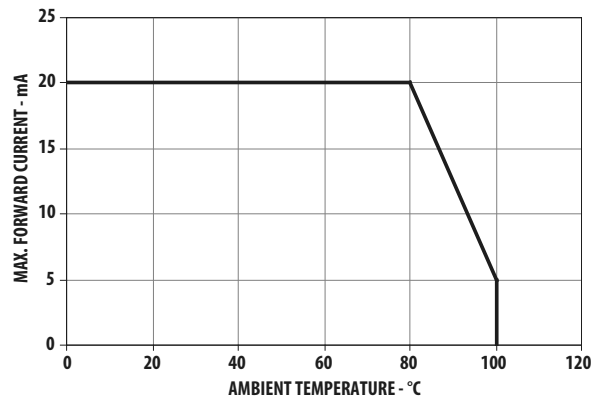

Figure 5: Radiation Pattern

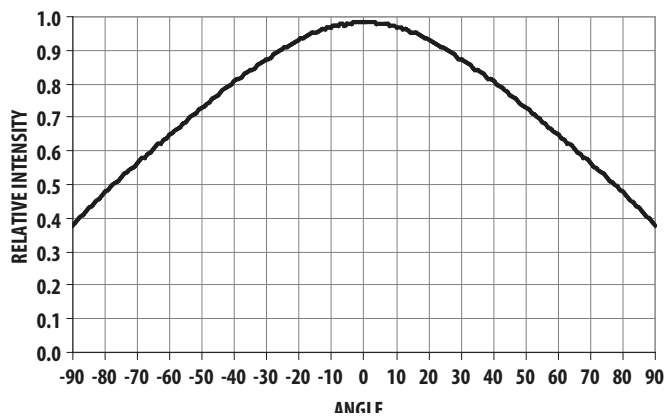
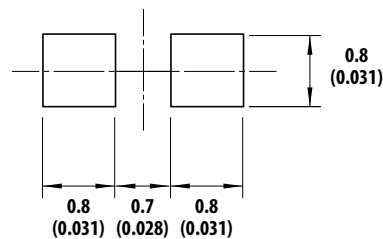

Figure 6: Recommended Soldering Land Pattern



1. All dimensions are in millimeters (inches).
2. Tolerance is ±0.1 mm (±0.004 in.) unless otherwise specified.

Figure 7: Recommended Reflow Soldering Profile

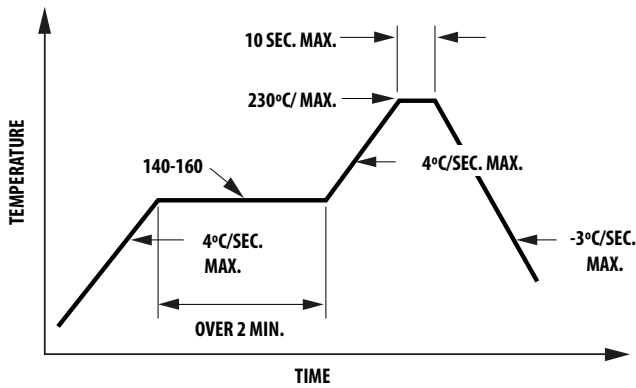
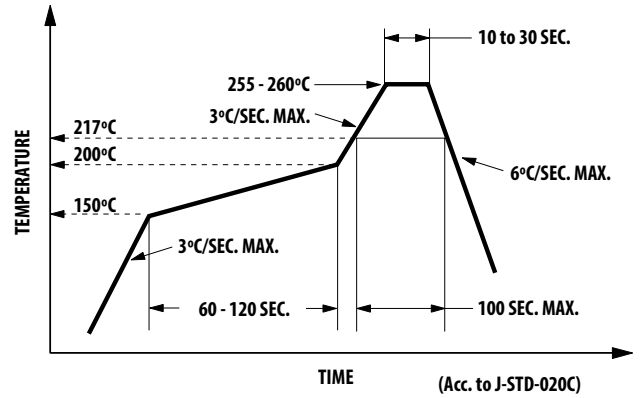

Figure 8: Recommended Pb-Free Reflow Soldering Profile



**NOTE:** For detailed information on reflow soldering of Broadcom surface mount LEDs, refer to Broadcom Application Note AN1060, *Surface Mounting SMT LED Indicator Components*.

Figure 9: Tape Dimensions

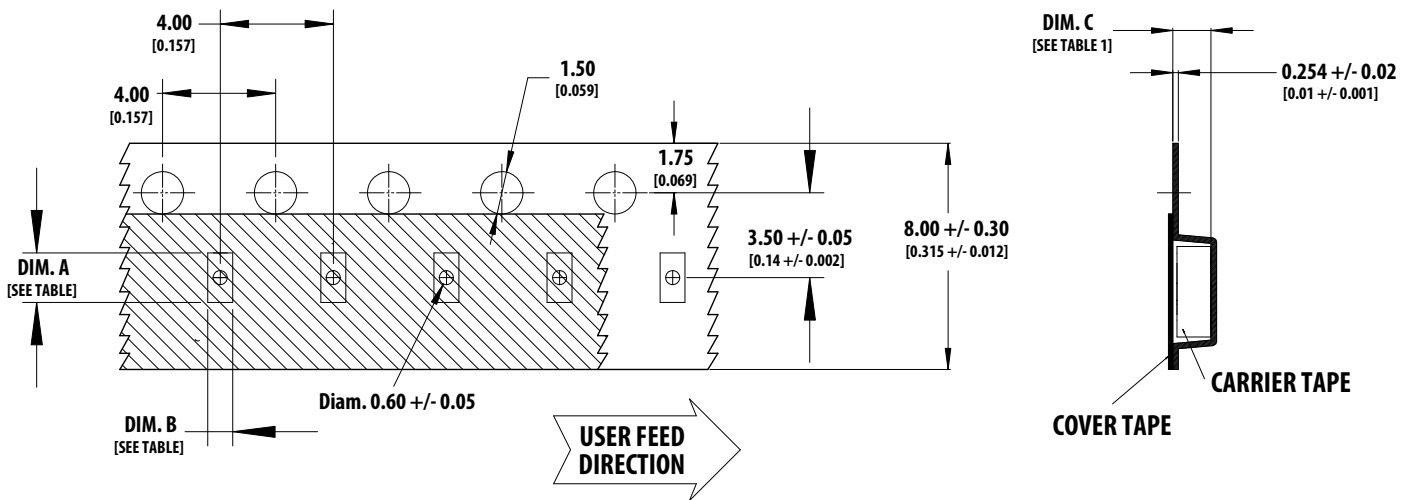
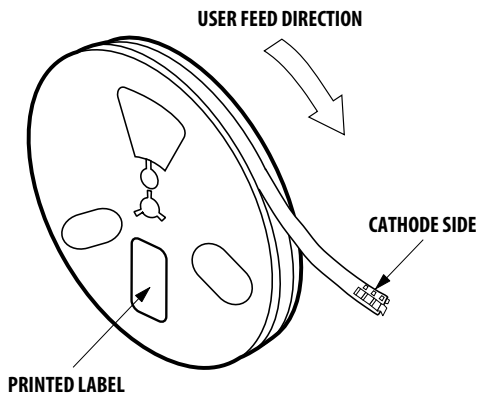

Figure 10: Reeling Orientation



## Intensity Bin Select ( $X_3X_4$ )

The individual reel contains parts from one-half bin only.

$X_3$	Min $I_V$ Bin
-------	---------------

$X_4$	Number of Intensity Bins
0	Full Distribution
2	2 half bins starting from $X_31$
3	3 half bins starting from $X_31$
4	4 half bins starting from $X_31$
5	5 half bins starting from $X_31$
6	2 half bins starting from $X_32$
7	3 half bins starting from $X_32$
8	4 half bins starting from $X_32$
9	5 half bins starting from $X_32$

## Luminous Intensity ( $I_V$ ) Bin Limits

Bin ID	Intensity (mcd)	
	Min.	Max.
A1	0.11	0.14
A2	0.14	0.18
B1	0.18	0.23
B2	0.23	0.29
C1	0.29	0.36
C2	0.36	0.45
D1	0.45	0.57
D2	0.57	0.72
E1	0.72	0.90
E2	0.90	1.10
F1	1.10	1.41
F2	1.41	1.80
G1	1.80	2.24
G2	2.24	2.80
H1	2.80	3.55
H2	3.55	4.50
J1	4.50	5.70
J2	5.70	7.20
K1	7.20	9.00
K2	9.00	11.20
L1	11.20	14.20
L2	14.20	18.00
M1	18.00	22.50
M2	22.50	28.00
N1	28.00	36.00
N2	36.00	45.00
P1	45.00	57.00
P2	57.00	71.50
Q1	71.50	90.00
Q2	90.00	113.00
R1	113.00	142.00
R2	142.00	180.00
S1	180.00	227.00
S2	227.00	285.00

Tolerance:  $\pm 15\%$ .

## Color Bin Select (X<sub>5</sub>)

The individual reel contains parts from one full bin only.

X <sub>5</sub>	Color Bin Selection
0	Full Distribution
Z	A and B only
Y	B and C only
W	C and D only
V	D and E only
U	E and F only
T	F and G only
S	G and H only
Q	A, B, and C only
P	B, C, and D only
N	C, D, and E only
M	D, E, and F only
L	E, F, and G only
K	F, G, and H only
J	Special Color Bin
1	A, B, C, and D only
2	E, F, G, and H only
3	B, C, D, and E only
4	C, D, E, and F only
5	A, B, C, D, and E only
6	B, C, D, E, and F only

## Packaging Option (X<sub>6</sub>)

Option	Test Current	Package Type	Reel Size
2	20 mA	Top Mount	7 Inch
H	2 mA	Top Mount	7 Inch
K	5 mA	Top Mount	7 Inch

## Forward Voltage (V<sub>F</sub>) Bin Limits

Bin ID	Forward Voltage (V)	
	Min.	Max.
1	1.60	1.80
2	1.80	2.00
3	2.00	2.20
4	2.20	2.40

Tolerance: ±0.1V.

## Color Bin Limits

### Yellow Green Color Bin

Bin ID	Dominant Wavelength (nm)	
	Min.	Max.
E	564.5	567.5
F	567.5	570.5
G	570.5	573.5
H	573.5	576.5

### Yellow/Amber Color Bin

Bin ID	Dominant Wavelength (nm)	
	Min.	Max.
A	582.0	584.5
B	584.5	587.0
C	587.0	589.5
D	589.5	592.0
E	592.0	594.5
F	594.5	597.0

### Orange Color Bin

Bin ID	Dominant Wavelength (nm)	
	Min.	Max.
A	597.0	600.0
B	600.0	603.0
C	603.0	606.0
D	606.0	609.0
E	609.0	612.0

### Red Color Bin

Bin ID	Dominant Wavelength (nm)	
	Min.	Max.
Full Distribution	620.0	635.0

### Red Orange Color Bin

Bin ID	Dominant Wavelength (nm)	
	Min.	Max.
A	610.0	615.0
B	615.0	620.0

Tolerance: ±1 nm.



## Moisture Sensitivity

This product is qualified as moisture sensitivity level 2a per JEDEC J-STD-020. Take precautions when handling this moisture sensitive product to ensure the reliability of the product. Refer to Broadcom Application Note AN5305, *Handling of Moisture Sensitive Surface Mount Devices* for details.

### Storage before Use

- An unopen moisture barrier bag (MBB) can be stored at < 40°C/90% RH for 12 months. If the actual shelf life has exceeded 12 months and the humidity indicator card (HIC) indicates that baking is not required, then it is safe to reflow the LEDs per the original MSL rating.
- Do not open the MBB prior to assembly (for example, for IQC).

### Control after Opening the MBB

- Read the HIC when opening the MBB.
- Keep the LEDs at < 30°C/60% RH at all times and for all high-temperature-related processes, including soldering, curing, or rework that must be completed within 672 hours.

### Control for the Unfinished Reel

- Store unused LEDs in a sealed MBB with desiccant or desiccator at < 5% RH.

### Control of Assembled Boards

- If the PCB soldered with the LEDs is to be subjected to other high-temperature processes, store the PCB in a sealed MBB with desiccant or desiccator at <5% RH to ensure that no LEDs have exceeded their floor life of 672 hours.

### Baking Is Required for the Following Conditions

- “10%” or “15%” on the HIC turns pink.
- The LEDs are exposed to conditions of > 30°C/60% RH at any time.
- The LEDs’ floor life exceeded 672 hours.

The recommended baking condition is 60°C ± 5°C for 20 hours.

Copyright © 2014–2022 Broadcom. All Rights Reserved. The term “Broadcom” refers to Broadcom Inc. and/or its subsidiaries. For more information, go to [www.broadcom.com](http://www.broadcom.com). All trademarks, trade names, service marks, and logos referenced herein belong to their respective companies.

Broadcom reserves the right to make changes without further notice to any products or data herein to improve reliability, function, or design. Information furnished by Broadcom is believed to be accurate and reliable. However, Broadcom does not assume any liability arising out of the application or use of this information, nor the application or use of any product or circuit described herein, neither does it convey any license under its patent rights nor the rights of others.

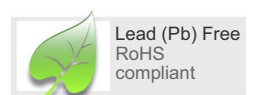

# Mouser Electronics

Authorized Distributor

Click to View Pricing, Inventory, Delivery & Lifecycle Information:

[Broadcom Limited:](#)

[ASMT-RA45-AP932](#) [ASMT-RF45-AN002](#) [ASMT-RH45-AQ502](#) [ASMT-RR45-AQ902](#) [ASMT-RJ45-AQ502](#)