

## 1500 W TVS in SMC

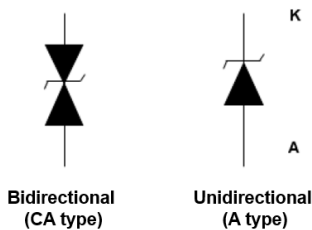
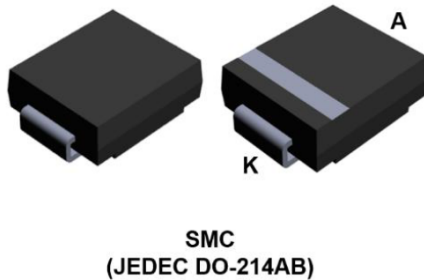

### Features

- Peak pulse power:
  - 1500 W (10/1000  $\mu$ s)
  - up to 10 kW (8/20  $\mu$ s)
- Stand-off voltage range from 5 V to 188 V
- Unidirectional and bidirectional types
- Low leakage current: 0.2  $\mu$ A at 25 °C
- Operating  $T_j$  max: 150 °C
- High power capability at  $T_j$  max.: up to 1250 W (10/1000  $\mu$ s)
- Lead finishing: matte tin plating

### Complies with the following standards

- UL94, V0
- J-STD-020 MSL level 1
- J-STD-002, JESD 22-B102 E3 and MIL-STD-750, method 2026
- JESD-201 class 2 whisker test
- IPC7531 footprint and JEDEC registered package outline
- IEC 61000-4-4 level 4:
  - 4 k V
- IEC 61000-4-2, C = 150 pF, R = 330  $\Omega$  exceeds level 4:
  - 30 kV (air discharge)
  - 30 kV (contact discharge)

### Description

The TVS series are designed to protect sensitive equipment against electrostatic discharges according to IEC 61000-4-2, MIL STD 883 Method 3015, and electrical overstress such as IEC 61000-4-4 and 5. They are used for surges below 1500 W 10/1000  $\mu$ s.

This planar technology makes it compatible with high-end equipment and SMPS where low leakage current and high junction temperature are required to provide reliability and stability over time.

Product status link	
SMCJ	SMCJ5.0A, SMCJ5.0CA, SMCJ6.0A, SMCJ6.0CA, SMCJ6.5A, SMCJ6.5CA, SMCJ8.5A, SMCJ8.5CA, SMCJ10A, SMCJ10CA, SMCJ12A, SMCJ12CA, SMCJ13A, SMCJ13CA, SMCJ15A, SMCJ15CA, SMCJ18A, SMCJ18CA, SMCJ20A, SMCJ20CA, SMCJ22A, SMCJ22CA, SMCJ24A, SMCJ24CA, SMCJ26A, SMCJ26CA, SMCJ28A, SMCJ28CA, SMCJ30A, SMCJ30CA, SMCJ33A, SMCJ33CA, SMCJ40A, SMCJ40CA, SMCJ48A, SMCJ48CA, SMCJ58A, SMCJ58CA, SMCJ70A, SMCJ70CA, SMCJ85A, SMCJ85CA, SMCJ100A, SMCJ100CA, SMCJ130A, SMCJ130CA, SMCJ154A, SMCJ154CA, SMCJ170A, SMCJ170CA, SMCJ188A, SMCJ188CA

# 1 Characteristics

**Table 1. Absolute maximum ratings ( $T_{amb} = 25\text{ }^{\circ}\text{C}$ )**

Symbol	Parameter	Value	Unit	
$V_{PP}$	Peak pulse voltage	IEC 61000-4-2 (C = 150 pF, R = 330 $\Omega$ )		
		Contact discharge	30	kV
		Air discharge	30	
$P_{PP}$	Peak pulse power dissipation	$T_j \text{ initial} = T_{amb}$	1500	W
$T_{stg}$	Storage temperature range		-65 to +150	$^{\circ}\text{C}$
$T_j$	Operating junction temperature range		-55 to +150	$^{\circ}\text{C}$
$T_L$	Maximum lead temperature for soldering during 10 s		260	$^{\circ}\text{C}$

**Figure 1. Electrical characteristics - parameter definitions**

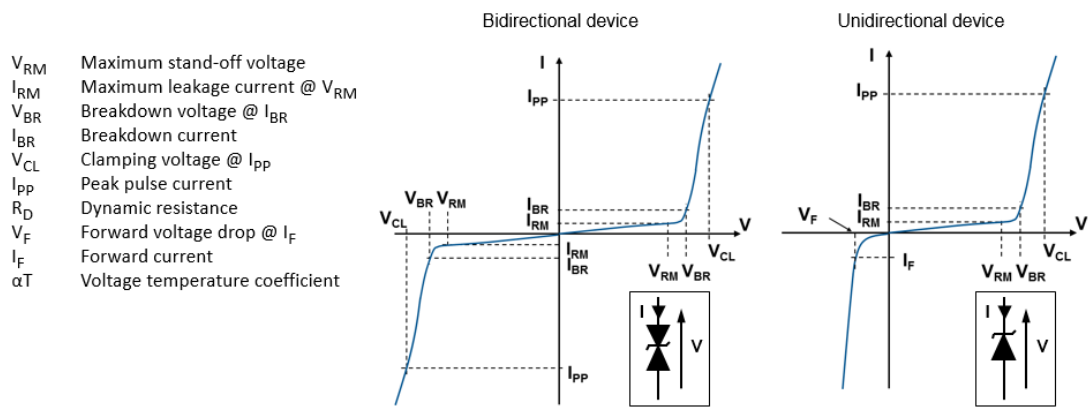

**Figure 2. Pulse definition for electrical characteristics**

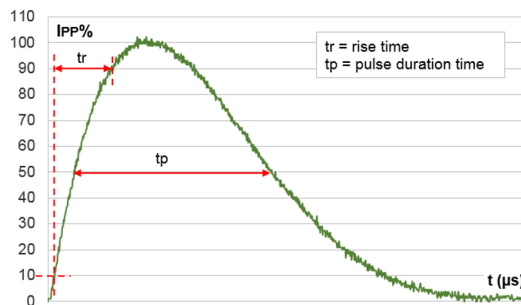

**Table 2. Electrical characteristics - parameter values ( $T_{amb} = 25\text{ }^{\circ}\text{C}$ , unless otherwise specified)**

Type	$I_{RM}$ max at $V_{RM}$			$V_{BR}$ at $I_R$ <sup>(1)</sup>			10 / 1000 $\mu\text{s}$			8 / 20 $\mu\text{s}$			$\alpha T$
	25 $^{\circ}\text{C}$	85 $^{\circ}\text{C}$		Min.	Typ.		$V_{CL}$ <sup>(2)(3)</sup>	$I_{PP}$ <sup>(4)</sup>	$R_D$	$V_{CL}$ <sup>(2)(3)</sup>	$I_{PP}$ <sup>(4)</sup>	$R_D$	
							Max.		Max.	Max.		Max.	Max.
	$\mu\text{A}$		V	V		mA	V	A	$\Omega$	V	A	m $\Omega$	$10^{-4}/^{\circ}\text{C}$
SMCJ5.0A/CA	500	2000	5	6.4	6.74	10	9.20	171	0.012	13.4	746	8.5	5.7
SMCJ6.0A/CA	500	2000	6	6.7	7.05	10	10.3	152	0.019	13.7	730	8.6	5.9
SMCJ6.5A/CA	250	1000	6.5	7.2	7.58	10	11.2	140	0.023	14.5	690	9.5	6.1
SMCJ8.5A/CA	10	50	8.5	9.4	9.9	1	14.4	105	0.038	19.5	512	18	7.3
SMCJ10A/CA	0.2	1	10	11.1	11.7	1	17	92	0.051	21.7	461	20	7.8
SMCJ12A/CA	0.2	1	12	13.3	14	1	19.9	79	0.066	25.3	394	27	8.3
SMCJ13A/CA	0.2	1	13	14.4	15.2	1	21.5	73	0.076	27.2	368	31	8.4
SMCJ15A/CA	0.2	1	15	16.7	17.6	1	24.4	64	0.092	32.5	308	46	8.8
SMCJ18A/CA	0.2	1	18	20	21.1	1	29.2	53	0.133	39.3	254	68	9.2
SMCJ20A/CA	0.2	1	20	22.2	23.4	1	32.4	48	0.163	42.8	234	78	9.4
SMCJ22A/CA	0.2	1	22	24.4	25.7	1	35.5	44	0.194	48.3	207	103	9.6
SMCJ24A/CA	0.2	1	24	26.7	28.1	1	38.9	40	0.235	50	200	102	9.6
SMCJ26A/CA	0.2	1	26	28.9	30.4	1	42.1	37	0.275	53.5	187	115	9.7
SMCJ28A/CA	0.2	1	28	31.1	32.7	1	45.4	34	0.325	59	169	146	9.8
SMCJ30A/CA	0.2	1	30	33.3	35.1	1	48.4	32	0.361	64.3	156	176	9.9
SMCJ33A/CA	0.2	1	33	36.7	38.6	1	53.3	29	0.440	69.7	143	204	10.0
SMCJ40A/CA	0.2	1	40	44.4	46.7	1	64.5	24	0.644	84	119	294	10.1
SMCJ48A/CA	0.2	1	48	53.3	56.1		77.4	20	0.925	100	100	411	10.3
SMCJ58A/CA	0.2	1	58	64.4	67.8	1	93.6	16	1.40	121	83	600	10.4
SMCJ70A/CA	0.2	1	70	77.8	81.9	1	113	13.9	1.94	146	69	870	10.5
SMCJ85A/CA	0.2	1	85	94	99	1	137	11.5	2.87	178	56	1322	10.6
SMCJ100A/CA	0.2	1	100	111	117	1	162	9.7	4.04	212	47	1897	10.7
SMCJ130A/CA	0.2	1	130	144	152	1	209	7.5	6.59	265	38	2774	10.8
SMCJ154A/CA	0.2	1	154	171	180	1	246	6.1	9.34	317	31.5	4063	10.8
SMCJ170A/CA	0.2	1	170	189	199	1	274	5.5	11.8	353	28	5145	10.8
SMCJ188A/CA	0.2	1	188	209	220	1	328	4.6	21.1	388	26	6038	10.8

1. To calculate  $V_{BR}$  versus  $T_j$ :  $V_{BR}$  at  $T_j = V_{BR}$  at  $25\text{ }^{\circ}\text{C} \times (1 + \alpha T \times (T_j - 25))$
2. To calculate  $V_{CL}$  versus  $T_j$ :  $V_{CL}$  at  $T_j = V_{CL}$  at  $25\text{ }^{\circ}\text{C} \times (1 + \alpha T \times (T_j - 25))$
3. To calculate  $V_{CL}$  max versus  $I_{PP\text{appli}}$ :  $V_{CL\text{max}} = V_{CL} - R_D \times (I_{PP} - I_{PP\text{appli}})$  where  $I_{PP\text{appli}}$  is the surge current in the application
4. Surge capability given for both directions for unidirectional and bidirectional devices

## 1.1 Characteristics curves

**Figure 3. Maximum peak power dissipation versus initial junction temperature**

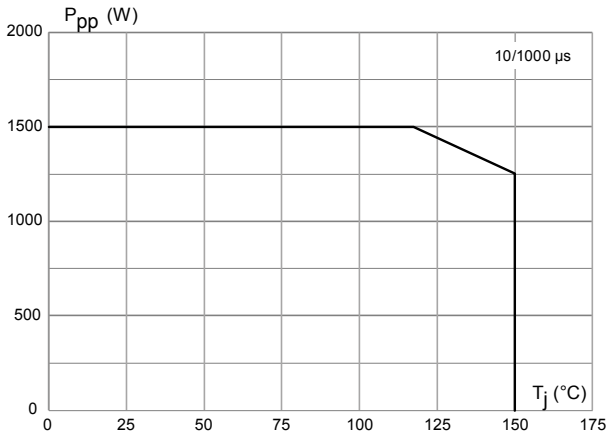

**Figure 4. Maximum peak pulse power versus exponential pulse duration**

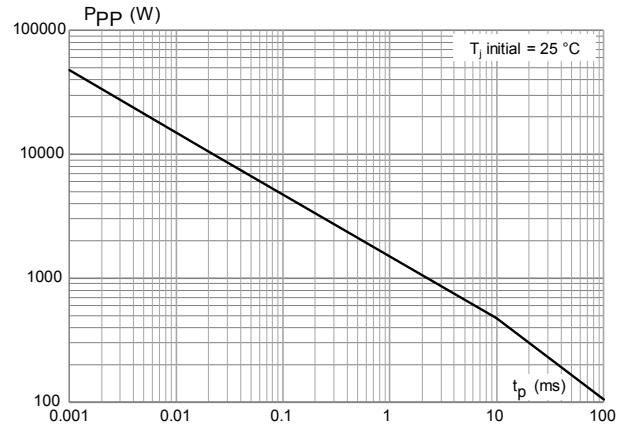

**Figure 5. Maximum peak pulse current versus clamping voltage**

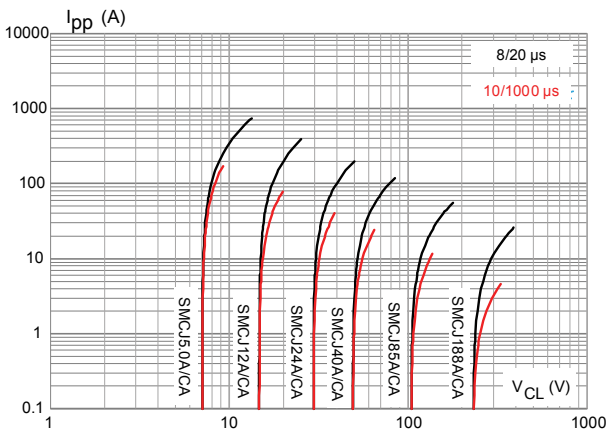

**Figure 6. Dynamic resistance versus pulse duration**

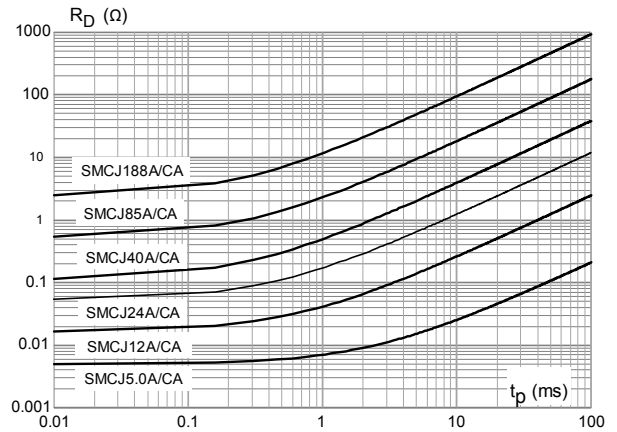

**Figure 7. Junction capacitance versus applied voltage (unidirectional type)**

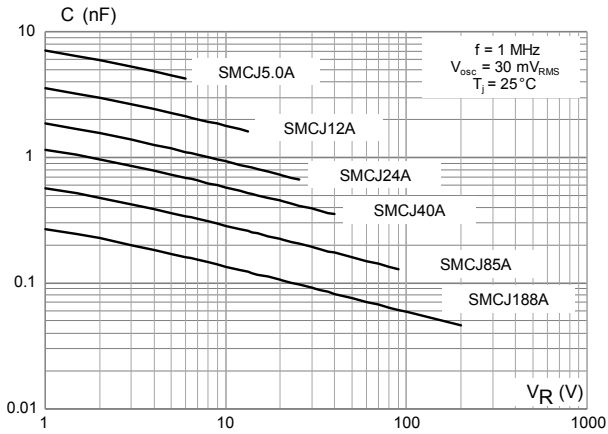

**Figure 8. Junction capacitance versus applied voltage (bidirectional type)**

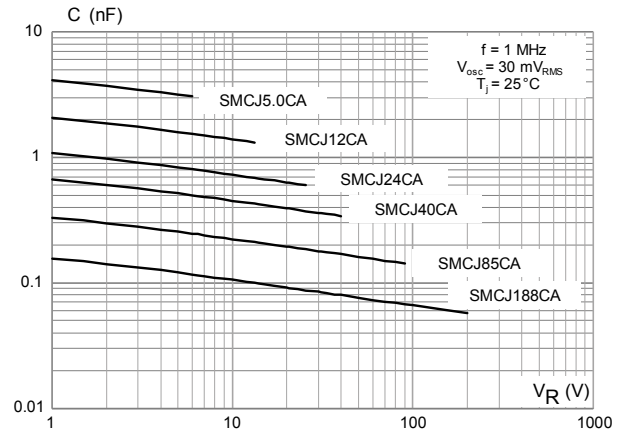

**Figure 9. Leakage current versus junction temperature**

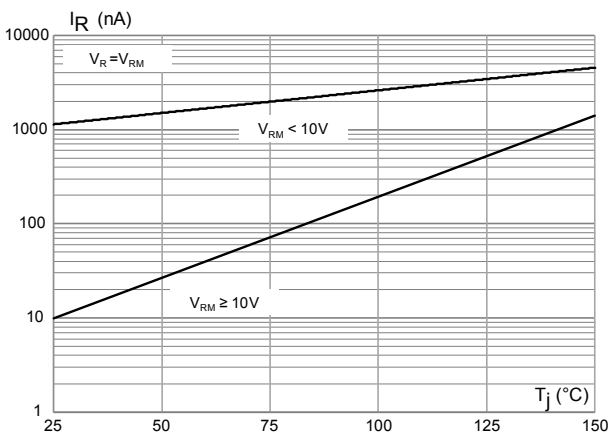

**Figure 10. Peak forward voltage drop versus peak forward current**

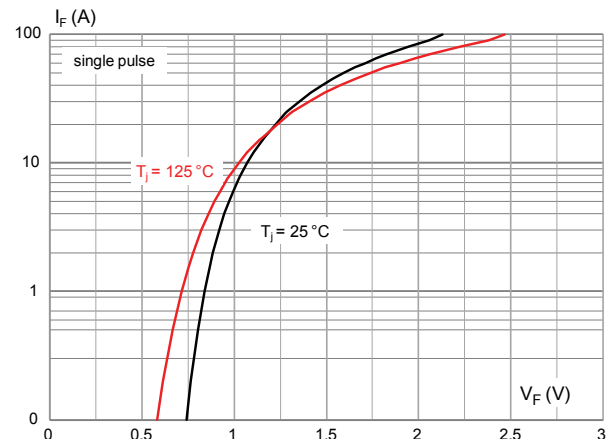

**Figure 11. Thermal impedance junction to ambient versus pulse duration**

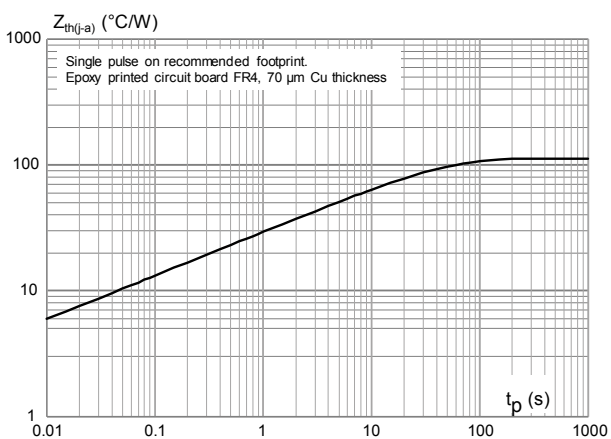

**Figure 12. Thermal resistance junction to ambient versus copper area under each lead**

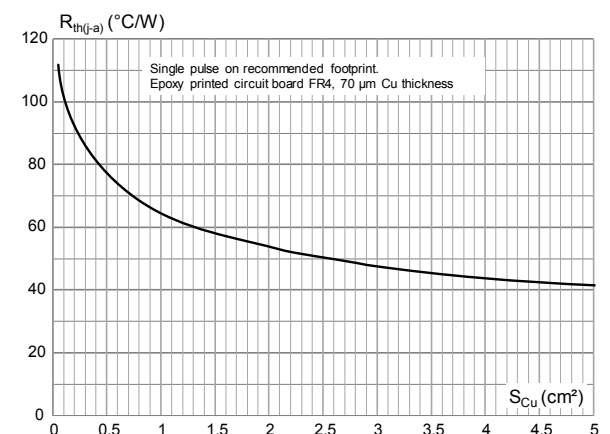

## 2 Package information

In order to meet environmental requirements, ST offers these devices in different grades of **ECOPACK** packages, depending on their level of environmental compliance. ECOPACK specifications, grade definitions and product status are available at: [www.st.com](http://www.st.com). ECOPACK is an ST trademark.

### 2.1 SMC package information

- Epoxy meets UL94, V0

Figure 13. SMC package outline

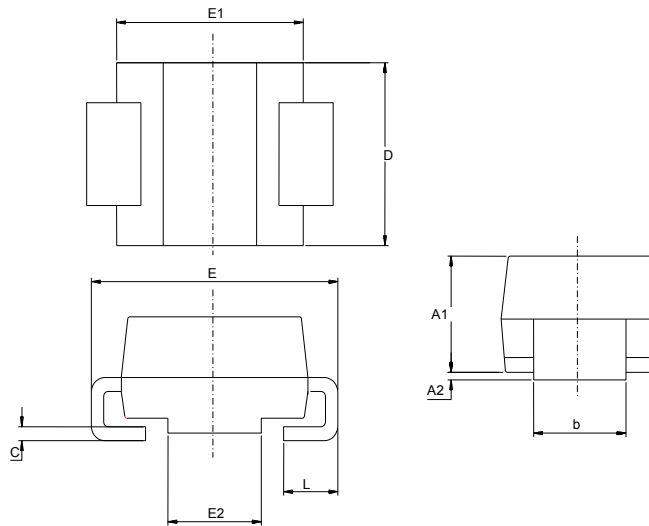

Table 3. SMC package mechanical data

Ref.	Dimensions			
	Millimeters		Inches (for reference only)	
	Min.	Max.	Min.	Max.
A1	1.90	2.45	0.075	0.096
A2	0.05	0.20	0.002	0.008
b	2.90	3.20	0.114	0.126
c	0.15	0.40	0.006	0.016
D	5.55	6.25	0.218	0.246
E	7.75	8.15	0.305	0.321
E1	6.60	7.15	0.260	0.281
E2	4.40	4.70	0.173	0.185
L	0.75	1.50	0.030	0.060

Figure 14. Footprint recommendation

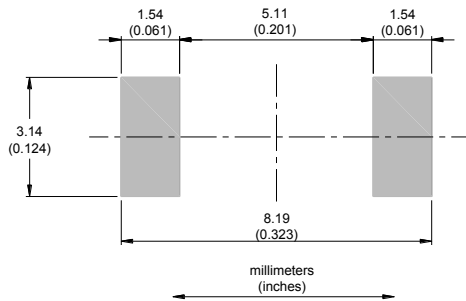

Figure 15. Marking layout

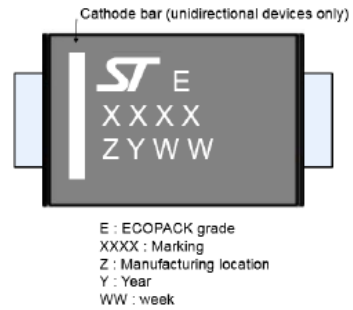
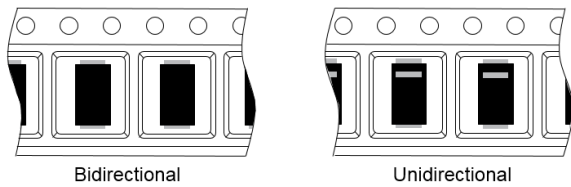

Figure 16. Package orientation in reel



Taped according to EIA-481  
Pocket dimensions are not on scale.  
Pocket shape may vary depending on package  
On bidirectional devices, marking and logo may not be always in the same direction.

Figure 17. Tape and reel orientation

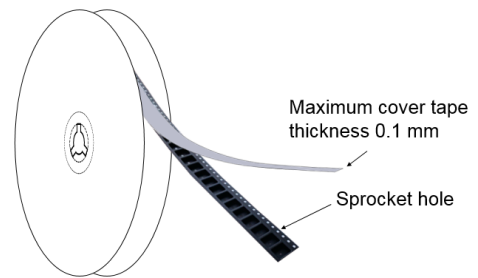

Figure 18. 13" reel dimension values (mm)

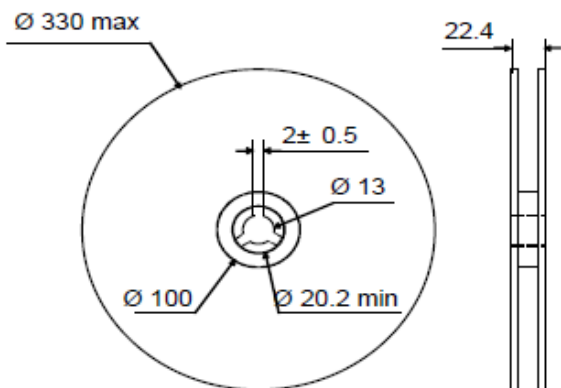

Figure 19. Inner box dimension values (mm)

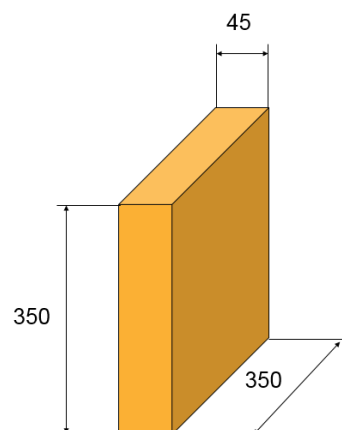
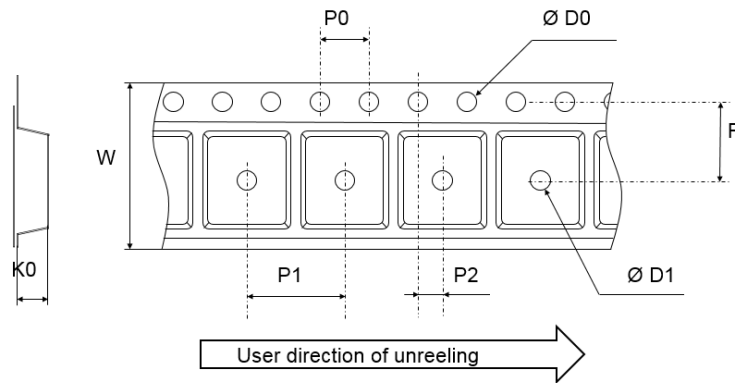

Figure 20. Tape outline



Note: Pocket dimensions are not on scale  
Pocket shape may vary depending on package

Table 4. Tape dimension values

Ref.	Dimensions		
	Millimeters		
	Min.	Typ.	Max.
D0	1.4	1.5	1.6
D1	1.5		
F	7.4	7.5	7.6
K0	2.39	2.49	2.59
P0	3.9	4.0	4.1
P1	7.9	8.0	8.1
P2	1.9	2.0	2.1
W	15.7	16	16.3



## 2.2 Reflow profile

Figure 21. ST ECOPACK recommended soldering reflow profile for PCB mounting

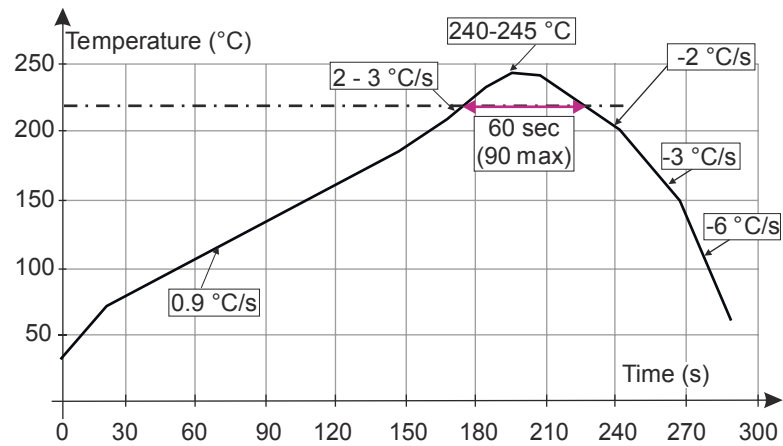

*Note: Minimize air convection currents in the reflow oven to avoid component movement. Maximum soldering profile corresponds to the latest IPC/JEDEC J-STD-020.*

### 3 Ordering information

**Table 5. Ordering information**

Order code	Marking	Package	Weight	Base qty.	Delivery mode
SMCJxxA/CA-TR <sup>(1)</sup>	See Table 6. Marking	SMC	0.25 g	2500	Tape and reel

1. Where xxx is nominal value of  $V_{BR}$  and A or CA indicates unidirectional or bidirectional version.

**Table 6. Marking**

Order code	Marking	Order code	Marking
SMCJ5.0A-TR	FUA	SMCJ5.0CA-TR	FBA
SMCJ6.0A-TR	FUB	SMCJ6.0CA-TR	FBB
SMCJ6.5A-TR	FUC	SMCJ6.5CA-TR	FBC
SMCJ8.5A-TR	FUD	SMCJ8.5CA-TR	FBD
SMCJ10A-TR	FUF	SMCJ10CA-TR	FBF
SMCJ12A-TR	FUH	SMCJ12CA-TR	FBH
SMCJ13A-TR	FUI	SMCJ13CA-TR	FBI
SMCJ15A-TR	FUJ	SMCJ15CA-TR	FBJ
SMCJ18A-TR	FUL	SMCJ18CA-TR	FBL
SMCJ20A-TR	FUM	SMCJ20CA-TR	FBM
SMCJ22A-TR	FUN	SMCJ22CA-TR	FBN
SMCJ24A-TR	FUO	SMCJ24CA-TR	FBO
SMCJ26A-TR	FUP	SMCJ26CA-TR	FBP
SMCJ28A-TR	FUQ	SMCJ28CA-TR	FBQ
SMCJ30A-TR	FUR	SMCJ30CA-TR	FBR
SMCJ33A-TR	FUS	SMCJ33CA-TR	FBS
SMCJ40A-TR	FUU	SMCJ40CA-TR	FBU
SMCJ48A-TR	FUW	SMCJ48CA-TR	FBW
SMCJ58A-TR	FUZ	SMCJ58CA-TR	FBZ
SMCJ70A-TR	GUB	SMCJ70CA-TR	GBB
SMCJ85A-TR	GUE	SMCJ85CA-TR	GBE
SMCJ100A-TR	GUG	SMCJ100CA-TR	GBG
SMCJ130A-TR	GUI	SMCJ130CA-TR	GBI
SMCJ154A-TR	GUL	SMCJ154CA-TR	GBL
SMCJ170A-TR	GUM	SMCJ170CA-TR	GBM
SMCJ188A-TR	GUN	SMCJ188CA-TR	GBN

## Revision history

**Table 7. Document revision history**

Date	Version	Changes
August-1999	5	Previous update.
14-May-2009	6	Reformatted to current standards. Updated ECOPACK statement.
17-Sep-2009	7	Document updated for low leakage current.
12-Jul-2010	8	Changed timescale in Figure 9.
03-Feb-2020	9	Minor text changes to improve readability. Updated Table 2. Electrical characteristics - parameter values ( $T_{amb} = 25\text{ °C}$ , unless otherwise specified) and Section 1.1 Characteristics (curves).
12-Mar-2020	10	Updated title of the document. Removed section 3. Application and design guidelines.
14-Dec-2020	11	Updated Table 2.

**IMPORTANT NOTICE – PLEASE READ CAREFULLY**

STMicroelectronics NV and its subsidiaries (“ST”) reserve the right to make changes, corrections, enhancements, modifications, and improvements to ST products and/or to this document at any time without notice. Purchasers should obtain the latest relevant information on ST products before placing orders. ST products are sold pursuant to ST’s terms and conditions of sale in place at the time of order acknowledgement.

Purchasers are solely responsible for the choice, selection, and use of ST products and ST assumes no liability for application assistance or the design of Purchasers’ products.

No license, express or implied, to any intellectual property right is granted by ST herein.

Resale of ST products with provisions different from the information set forth herein shall void any warranty granted by ST for such product.

ST and the ST logo are trademarks of ST. For additional information about ST trademarks, please refer to [www.st.com/trademarks](http://www.st.com/trademarks). All other product or service names are the property of their respective owners.

Information in this document supersedes and replaces information previously supplied in any prior versions of this document.

© 2020 STMicroelectronics – All rights reserved

# Mouser Electronics

Authorized Distributor

Click to View Pricing, Inventory, Delivery & Lifecycle Information:

[STMicroelectronics:](#)

[SMCJ15A-TR](#) [SMCJ188CA-TR](#) [SMCJ22A-TR](#) [SMCJ40A-TR](#) [SMCJ188A-TR](#) [SMCJ33A-TR](#) [SMCJ18CA-TR](#)  
[SMCJ48CA-TR](#) [SMCJ5.0CA-TR](#) [SMCJ30A-TR](#) [SMCJ30CA-TR](#) [SMCJ40CA-TR](#) [SMCJ12A-TR](#) [SMCJ26A-TR](#)  
[SMCJ24CA-TR](#) [SMCJ130CA-TR](#) [SMCJ15CA-TR](#) [SMCJ28A-TR](#) [SMCJ5.0A-TR](#) [SMCJ6.0A-TR](#) [SMCJ33CA-TR](#)  
[SMCJ13CA-TR](#) [SMCJ85CA-TR](#) [SMCJ170A-TR](#) [SMCJ70CA-TR](#) [SMCJ20A-TR](#)