



SERIES 516



FEATURES

UL Recognized.

.150 (3.81) Contact Spacing x .150 (3.81) Row Spacing with Staggered Gold

Plug & Receptacle in 20, 38, 56, 90 or 120 Contact Sizes

Edacon Hermaphroditic Contact Mating Design

Contact Termination Options include Crimp, P.C. Tail, Wire Hole and Wire Wrap

Mating and Unmating Simplified with use of Actuating Screws

Optional Covers with Side or Top Entry Cable Clamp in Plastic or Metal Material Available for all Connector Sizes

Versatile Metal Cover Design permits Assembly or Disassembly After Cabling is Complete plus Cable Entry Style Flexibility

Actuating Screws, Locknuts, Polarizing Hardware, Covers and Contacts Suitable for either Plug or Receptacle

Polarizing Hardware Adjustable for 288 Mating Combinations

Tools Available for Contact Installation, Removal and Crimping and Polarizing Changes

SPECIFICATIONS

Insulator Material: Thermoplastic Polyester or Diallyl Phthalate, UL 94V-0, Colour: Green, or Polycarbonate, Colour: Grey

Contact Material: Phosphor Bronze Alloy CA-510

Contact Plating: Gold over Nickel

Cover Material: Poly Carbonate, Colour Green or Die-Cast Zinc, finished with Grey Enamel Paint

Current Rating: 8.5 Amperes

Contact Resistance: 10 Milliohms Maximum

Dielectric Withstanding Voltage: 2000 V AC rms at Sea Level

Example Part Number 516 - 038 - 500 - 2 1 2



Series 516

Total Number of Contacts 020, 038, 056, 090 or 120

Contact Code	Description & Tail Size	Tail Length "G"
000	No Contacts Assembled	---
500	Wire Hole .110 x .024 (2.79 x 0.61)	.245 (6.22)
520	P.C. Tail .025 x .024 (0.64 x 0.61)	.215 (5.46)
540	Wire Wrap .050 x 0.24 (1.27 x 0.61)	.600 (15.24)
541	Wire Wrap .026 x .024 (0.66 x 0.61)	.620 (15.75)
542	Wire Wrap .050 x .024 (1.27 x .061)	.790 (20.07)

Style & Material	Style	Insulator Material
1	Plug	Green Diallyl Phthalate
2	Receptacle	Green Diallyl Phthalate
3	Plug	Grey Polycarbonate
4	Receptacle	Grey Polycarbonate
5	Plug	Green Polyester
6	Receptacle	Green Polyester

Cover Code	Description
0	No Cover Assembled
1	Plastic Cover, Top Entry Standard Clamp
2	Plastic Cover, Side Entry Standard Clamp
3	Plastic Cover, Top Entry Large Clamp
4	Plastic Cover, Side Entry Large Clamp
5	Metal Cover, Side Entry
6	Metal Cover, Top Entry

Hardware Code	Description
0	No Hardware Assembled
1	Actuating Screw and Polarizing Hardware
2	Locknut and Polarizing Hardware
5	Actuating Screw with No Polarizing Hardware
6	Locknut with No Polarizing Hardware

Ordering Code Notes

Crimp contacts are also available for the 516 series connectors. Contacts be ordered separately for pre-wired or select position assembly.

Part Number	Description	Silhouette
516-290-500	Wire Hole	
516-290-520	P.C. Tail	
516-290-540	Wire Wrap	
516-290-541	Wire Wrap	
516-290-542	Wire Wrap	
516-290-590	Crimp - Loose	
516-290-591	Crimp - 1800 Contacts per reel	

Continued on next page

Insulation Resistance: 5000 Milliohms Minimum

Operating Temperature: -65 to +125 Degrees C

Insertion and Withdrawal Force: 2 to 16 oz 0 (0.56 to 4.45 N) per Contact Position



ORDERING CODE NOTES (Continued)

- 2) For contact installation, removal and crimping tools, refer to page 72.
- 3) Grey polycarbonate insulator material is not available for the 120 pin size connector.
- 4) The 20 pin connector cover will not accept the length of the wire wrap contacts.
- 5) Plastic covers with large clamps are only available for the 38 and 56 pin size connectors.
- 6) Metal covers with side entry may be converted to top entry by removing side plate and changing clamp orientation.
- 7) Covers may be ordered separately. Refer to page 88.
- 8) Insulator design prevents improper mating of individual plug and receptacle. Polarizing hardware enables specific plug and receptacle mating combinations.

CRIMP CHARACTERISTICS

- Contacts and Crimp Tools Accommodate from 28 AWG to 18 AWG, Solid or Stranded Conductor Diameters from .012 (0.30) to .049 (1.25) and an Insulation Diameter up to .074 (1.88)
- Multiple Smaller Gauge Wires may be Crimped Together
- Crimp Resistance from 0.5 Milliohms (18 AWG) to 1.5 Milliohms (28AWG)

POLARIZING CODES

- Polarizing Hardware Changes allow 288 Mating Combinations
- Standard Code Supplied for Plugs PG1G1, for Receptacles RS1S1. Connectors with Special Polarizing Codes Available upon Request
- Example Polarizing Code:



• Crimp Tensile Strength for Wire Sizes

18 AWG - 40 lbs (178 N)	20 AWG - 25 lbs (111 N)
22 AWG - 15 lbs (67 N)	24 AWG - 10 lbs (44 N)
26 AWG - 5 lbs (22 N)	28 AWG - 3 lbs (13 N)

CONNECTOR MATING FACE VIEWS
 DIMENSIONS INDICATED FOR EACH SIZE APPLY TO BOTH PLUG AND RECEPTACLE

20 PIN PLUG

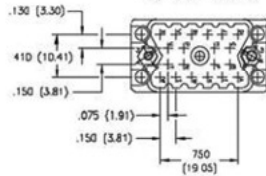

20 PIN RECEPTACLE

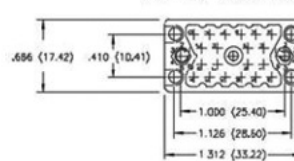

38 PIN PLUG

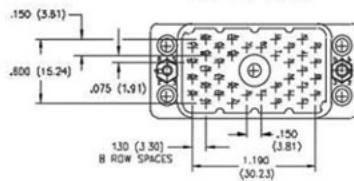

38 PIN RECEPTACLE

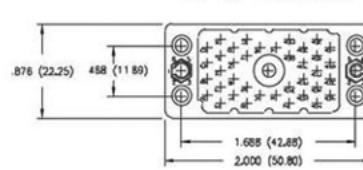

56 PIN PLUG

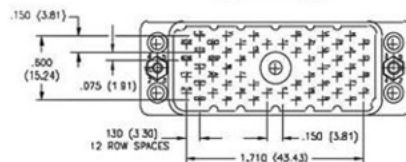

56 PIN RECEPTACLE

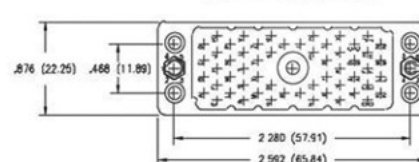

90 PIN PLUG

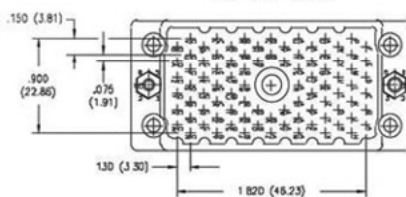

90 PIN RECEPTACLE

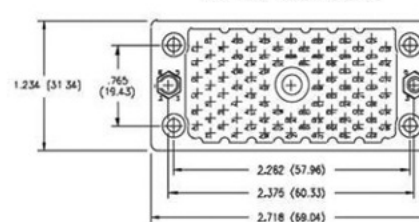

120 PIN PLUG

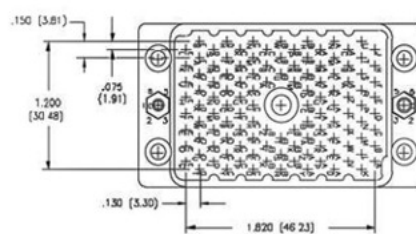

120 PIN RECEPTACLE

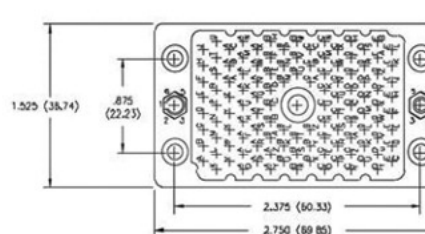



SERIES 516

Example Part Number 516 - 230 - 5 56

Series _____
 Cover Identification Code _____
 Cover Type _____
 Cover Size _____

Series 516

Cover Identification Code 230

Cover Type ^{1,2}	Description
1	Plastic Cover, Side Entry Standard Clamp
2	Plastic Cover, Top Entry Standard Clamp
3	Plastic Cover, Side Entry Large Clamp
4	Plastic Cover, Top Entry Large Clamp
5	Metal Cover, Side Entry
6	Metal Cover, Top Entry
7	Metal Cover, Large Clamp

Cover Size	Fits Connector
12	516 Series 120 Pin
20	516 Series 20 Pin and 519 Series 14 Pin
38	516 Series 38 Pin and 519 Series 36 Pin
56	516 Series 56 Pin
90	516 Series 90 Pin

Ordering Code Notes

- 1) Plastic covers with large clamps are only available for the 38 and 56 pin size connectors.
- 2) Metal covers with side entry may be converted to top entry by removing side plate and changing clamp orientation.

Features

Available in Metal (Die-Cast Zinc Finished with Grey Enamel Paint) or Plastic (Green Polycarbonate) Material

Covers with Top or Side Entry Cable Clamp.

Orientation of Clamp on Metal Covers may be changed by the Customer

Versatile Metal Cover Design permits Assembly or Disassembly after Cabling is Complete

Screws for Securing Cover to 516 or 519 Series Connectors Supplied

METAL COVERS



NEW COVER DESIGN (AVAILABLE SOON) WILL ELIMINATE 3 SCREWS FOR SIDE TO SIMPLIFY ASSEMBLY, DISASSEMBLY AND CLAMP ORIENTATION CHANGES

SCREWS FOR SECURING THE COVER TO THE CONNECTOR ARE SUPPLIED BY EDAC.

PLASTIC COVERS



COVER FOR CONNECTOR	COVER MATERIAL	CLAMP SIZE	"A"		"B"		"C"		"D"		"E"		"F"		"G"	
			Inch	(mm)	Inch	(mm)	Inch	(mm)	Inch	(mm)	Inch	(mm)	Inch	(mm)	Inch	(mm)
20 Pin	Plastic	Standard	1.605	(40.77)	1.325	(33.66)	.906	(23.01)	1.190	(30.23)	.715	(18.16)	.450	(11.43)	.450	(11.43)
20 Pin	Metal	Standard	1.539	(39.09)	1.325	(33.66)	.906	(23.01)	1.120	(28.45)	.686	(17.42)	.446	(11.33)	.490	(12.45)
38 Pin	Plastic	Standard	2.460	(62.48)	2.010	(51.05)	1.530	(38.86)	1.985	(50.42)	.910	(23.11)	.650	(16.51)	.500	(12.70)
38 Pin	Plastic	Large	2.460	(62.48)	2.010	(51.05)	1.530	(38.86)	1.985	(50.42)	1.110	(28.19)	.650	(16.51)	.608	(15.44)
38 Pin	Metal	Standard	2.206	(56.03)	2.006	(50.95)	1.566	(39.78)	1.766	(44.86)	.875	(22.23)	.720	(18.29)	.575	(14.61)
56 Pin	Plastic	Standard	3.052	(77.52)	2.602	(66.09)	1.530	(38.86)	1.985	(50.42)	.910	(23.11)	.650	(16.51)	.500	(12.70)
56 Pin	Plastic	Large	3.052	(77.52)	2.602	(66.09)	1.530	(38.86)	1.985	(50.42)	1.110	(28.19)	.650	(16.51)	.608	(15.44)
56 Pin	Metal	Standard	2.802	(71.17)	2.602	(66.09)	1.566	(39.78)	1.766	(44.86)	.875	(22.23)	.720	(18.29)	.575	(14.61)
90 Pin	Plastic	Standard	3.124	(79.35)	2.718	(69.04)	1.775	(45.09)	2.181	(55.40)	1.250	(31.75)	.800	(20.32)	.800	(20.32)
90 Pin	Metal	Standard	3.118	(79.20)	2.718	(69.04)	1.775	(45.09)	2.175	(55.25)	1.234	(31.34)	.880	(22.35)	.900	(22.86)
120 Pin	Plastic	Standard	3.156	(80.16)	2.750	(69.85)	2.020	(51.31)	2.426	(61.62)	1.530	(38.86)	.800	(20.32)	1.080	(27.43)
120 Pin	Metal	Standard	3.175	(80.65)	2.750	(69.85)	2.020	(51.31)	2.445	(62.10)	1.531	(38.89)	.890	(22.61)	1.080	(27.43)

RACK AND PANEL CONNECTORS

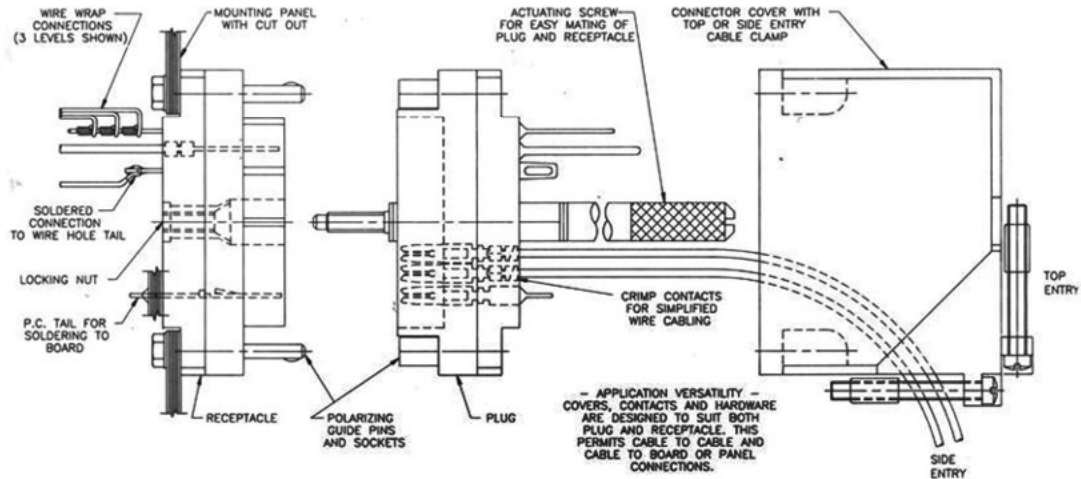

516 / 519 SERIES CONNECTOR PANEL MOUNTING CUT-OUT

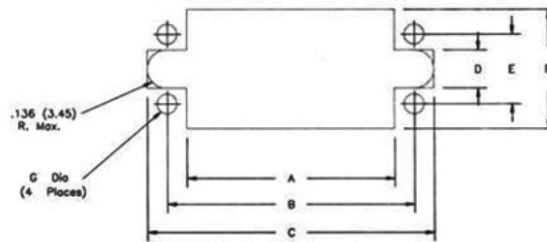

516 SERIES CONNECTOR CUT OUTS

CONNECTOR SIZE	A	B	C	D	E	F	G Dia
20 pin	.960 (24.38)	1.126 (28.6)	1.270 (32.26)	.260 (6.60)	.410 (10.41)	.640 (16.26)	.104 (2.64)
38 pin	1.420 (36.07)	1.688 (42.87)	1.958 (49.73)	.260 (6.60)	.468 (11.89)	.816 (20.73)	.136 (3.45)
56 pin	1.940 (49.28)	2.280 (57.91)	2.550 (64.77)	.260 (6.60)	.468 (11.89)	.816 (20.73)	.136 (3.45)
90 pin	2.050 (52.07)	2.282 (57.96)	2.675 (67.95)	.300 (7.62)	.765 (19.43)	1.120 (36.07)	.136 (3.45)
120 pin	2.050 (52.07)	2.375 (60.32)	2.675 (67.95)	.300 (7.62)	.875 (22.22)	1.420 (36.07)	.156 (3.96)

519 SERIES CONNECTOR CUT OUTS

CONNECTOR SIZE	A	B	C	D	E	F	G Dia
14 pin	.960 (24.38)	1.126 (28.6)	1.270 (32.26)	.260 (6.60)	.410 (10.41)	.640 (16.26)	.104 (2.64)
36 pin	1.420 (36.07)	1.688 (42.87)	1.958 (49.73)	.260 (6.60)	.468 (11.89)	.816 (20.73)	.136 (3.45)

EDAC

SERIES 516

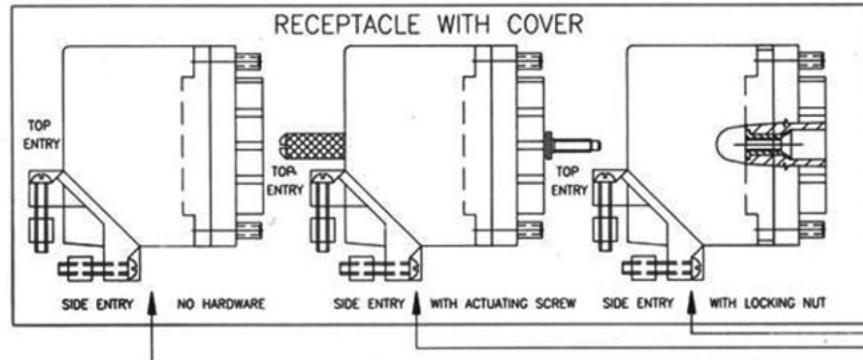
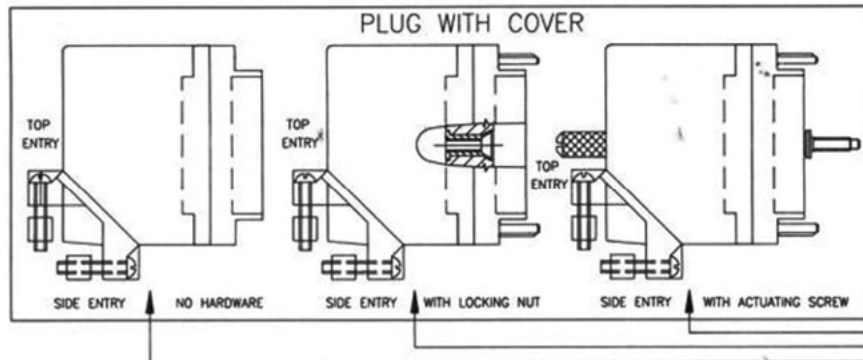
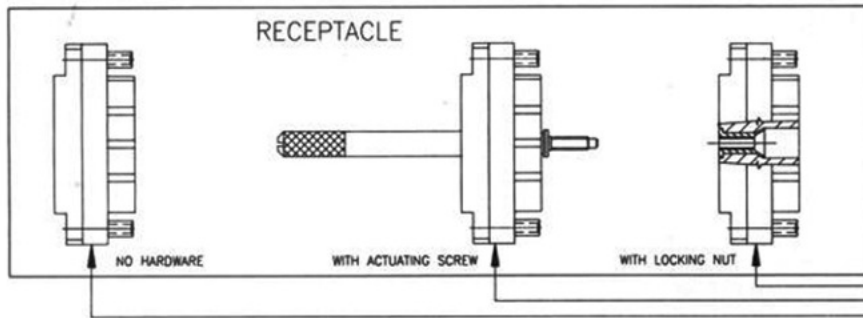
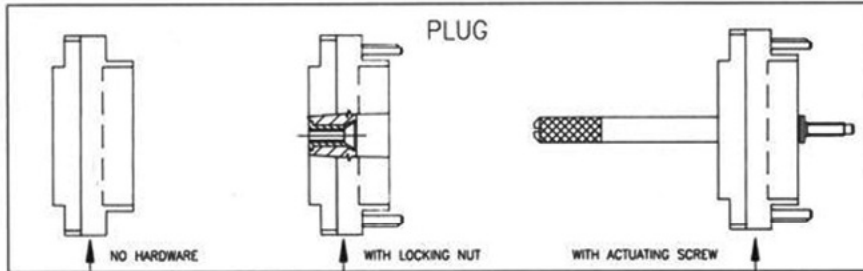

ORDERING CODE

516 056 540 102

SERIES NUMBER OF CONTACTS CONTACT CODE

DAP CODE	STYLE	DESCRIPTION	POLYCARB CODE
101	P L U G	ACTUATING SCREW	301
102		LOCKING NUT	302
100		NO HARDWARE	300
202	R E C E P T A C L E	ACTUATING SCREW	402
201		LOCKING NUT	401
200		NO HARDWARE	400

POLYCARBONATE CONNECTORS AVAILABLE IN 20,38,56 AND 90 PINS SIZES ONLY

CODE REC. CLAMP	STYLE	DESCRIPTION	CODE LARGE CLAMP
111	P L U G	ACTUATING SCREW, TOP ENTRY	131
121		ACTUATING SCREW, SIDE ENTRY	141
151		ACTUATING SCREW, METAL COVER	151
112		LOCKING, NUT TOP ENTRY	132
122		LOCKING, NUT SIDE ENTRY	142
152		LOCKING, NUT METAL COVER	152
110		NO HARDWARE, TOP ENTRY	152
120		NO HARDWARE, SIDE ENTRY	130
150		NO HARDWARE METAL COVER	150
211		R E C E P T A C L E	ACTUATING SCREW, TOP ENTRY
221	ACTUATING SCREW, SIDE ENTRY		241
251	ACTUATING SCREW, METAL COVER		251
212	LOCKING, NUT TOP ENTRY		232
222	LOCKING, NUT SIDE ENTRY		242
252	LOCKING, NUT METAL COVER		252
210	NO HARDWARE, TOP ENTRY		230
220	NO HARDWARE, SIDE ENTRY		240
250	NO HARDWARE METAL COVER		250

Mouser Electronics

Authorized Distributor

Click to View Pricing, Inventory, Delivery & Lifecycle Information:

EDAC:

[516-290-590](#) [516-290-500](#) [516-290-520](#) [516-290-541](#) [516-294-571](#) [516-280-500](#) [516-038-521-402](#) [516-056-521-402](#) [516-090-521-402](#) [516-221-038-202](#) [516-221-039-202](#) [516-221-090-202](#) [516-221-091-202](#) [516-222-038-102](#) [516-222-039-102](#) [516-222-090-102](#) [516-222-091-102](#) [516-230-599](#) [516-252-021-102](#) [516-252-091-102](#) [516-252-095-100](#) [516-253-035-100](#) [516-253-095-100](#) [516-253-138-107](#) [516-253-190-107](#) [516-254-091-109](#) [516-280-100-311](#) [516-280-206](#) [516-280-301-004](#) [516-280-301-005](#) [516-280-700](#) [516-280-700-LEA](#) [516-280-710](#) [516-280-750](#) [516-290-521](#) [516-290-571](#) [516-294-591](#) [516-230-290](#) [516-290-540](#) [516-290-542](#) [516-290-591](#) [516-281-032](#) [516-281-004](#) [516-281-059](#) [516-281-033](#)