

ISL8130EVAL2Z

Evaluation Board

AN1909
Rev 0.00
December 20, 2013

Introduction

The ISL8130 is a wide input range, synchronous buck controller. It is designed to drive N-Channel MOSFETs in a synchronous rectified buck topology for up to 25A load current. The ISL8130 integrates control, output adjustment, monitoring and protection functions into a single package. All the necessary components are with a 2.125 inch by 1.25 inch PCB area.

The ISL8130EVAL2Z provides simple, voltage mode control with fast transient response. The 0.6V internal reference as well as external reference can be selected via the REFIN pin.

The ISL8130 is offered in a space saving 4x4 QFN and easy-to-use 20 Ld QSOP packages.

Evaluation Board Specifications

TABLE 1. EVALUATION BOARD ELECTRICAL SPECIFICATIONS

SPEC	DESCRIPTION	MIN	TYP	MAX	UNIT
VIN	Input Voltage	5.6	12	16	V
VOU	Output Voltage	4.75	5.0	5.25	V
IOUT	Output Current		25		A
Fsw	Switching Frequency		280		kHz
η	Efficiency, VIN = 12V, IOUT = 25A		94		%

TABLE 2. RECOMMENDED COMPONENT SELECTION FOR QUICK EVALUATION

VOUT (V)	IOUT (A)	UPPER MOSFET	LOWER MOSFET	INDUCTOR	FSW/RT (kHz/k Ω)
5	25	2 X BSC057N03 LS	2 X BSC057N03 LS	SER2010-901ML	280/52.3
5	15	1 X BSC057N03 LS	1 X BSC030N03 LS	SER2009-901ML	500/31.6
3.3	25	2 X BSC057N03 LS	2 X BSC030N03 LS	SER2010-901ML	280/52.3
3.3	15	1 X BSC057N03 LS	1 X BSC030N03 LS	SER2009-901ML	500/31.6

Please contact Intersil Sales for assistance.

Recommended Equipment

The following equipment are recommended for evaluation:

- 0V to 30V power supply with 30A source current capability
- Electronic load capable of sinking 25A
- Digital Multimeters (DMMs)
- 100MHz Quad-Trace Oscilloscope

Quick Test Setup

1. Ensure that the Eval board is correctly connected to the power supply and the electronic load prior to apply any power. Please refer to Figure 2 for proper set-up.
2. Connect jumpers J1 to the Internal Reference position; Connect jumper J8 to the Disable position.
3. Turn on the power supply, VIN = 12V. The PWM should be inhibited at this time.
4. Connect jumper J8 to the Enable position. Adjust input voltage VIN within the specified range and observe output voltage. The output voltage variation should be within 4.75V to 5.25V.
5. Adjust load current within 25A. The output voltage variation should be within 4.75V to 5.25V.
6. Use oscilloscope to observe output ripple voltage and phase node ringing. For accurate measurement, please refer to Figure 3 for proper probe set-up.
7. Optimization. Please refer to Table 2 for optimization recommendation.

NOTE: Test points: VOUT, GND, GND, VIN are for voltage measurement only. Do not allow high current through these test points.



FIGURE 1. PHOTOGRAPH OF THE ISL8130EVAL2Z EVALUATION BOARD

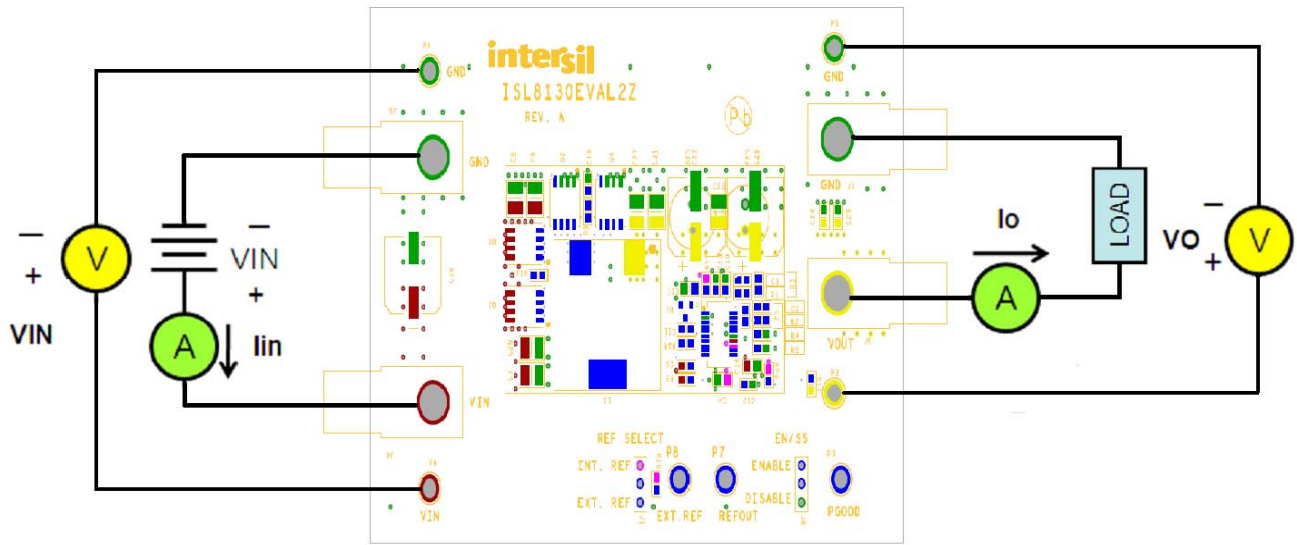

FIGURE 2. ISL8130EVAL2Z TEST SET-UP

Probe Set-up

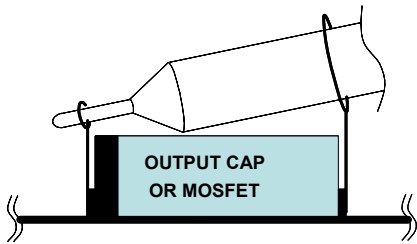

FIGURE 3. OSCILLOSCOPE PROBE SET-UP

External Reference

If REF_{IN} pin is tied to VCC5, then the internal 0.6V reference is used as the error amplifier non-inverting input. If the REF_{IN} is connected to an external voltage source between 0.6V to 1.25V, then this external voltage is used as the reference voltage at the positive input of the error amplifier.

Typical Performance Curves

Input voltage is 12V and output voltage is 5V unless otherwise specified.

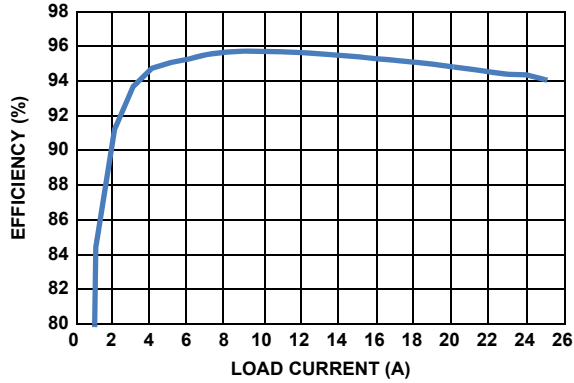

FIGURE 4. EFFICIENCY vs LOAD CURRENT

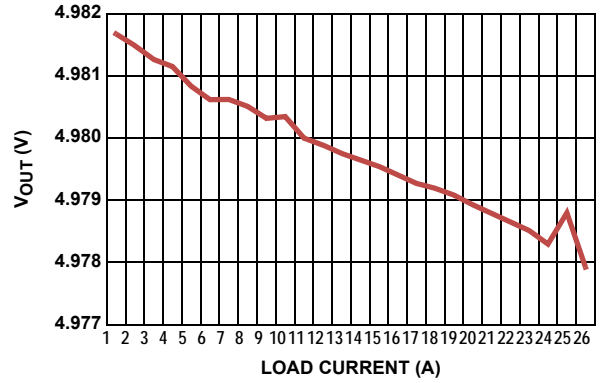

FIGURE 5. LOAD REGULATION, ($V_{IN} = 12V$, $I_{MAX} = 25A$)

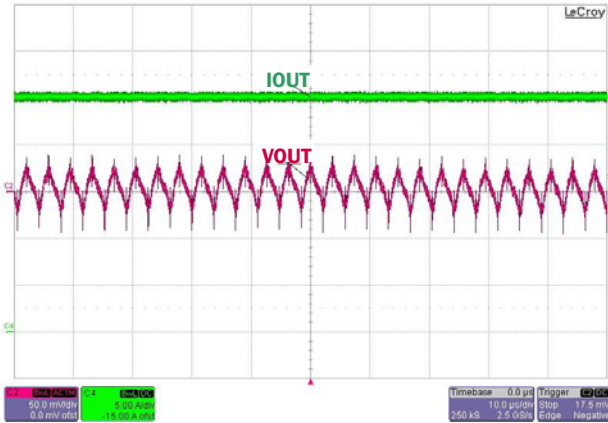

FIGURE 6. OUTPUT RIPPLE ($V_O = 5V$, $LOAD = 25A$)

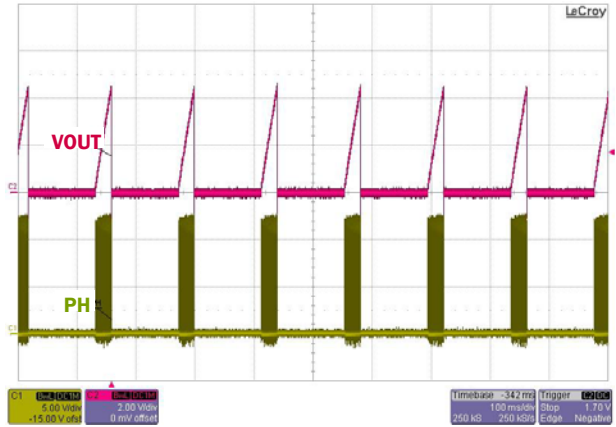

FIGURE 7. OVERCURRENT PROTECTION ($V_O = 5V$, $LOAD = 40A$)

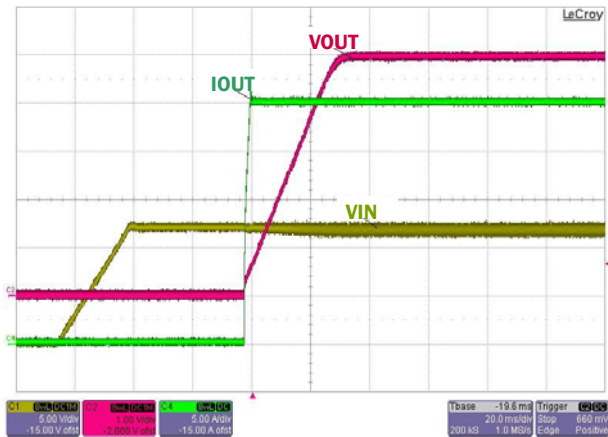

FIGURE 8. SOFT-START AT FULL LOAD

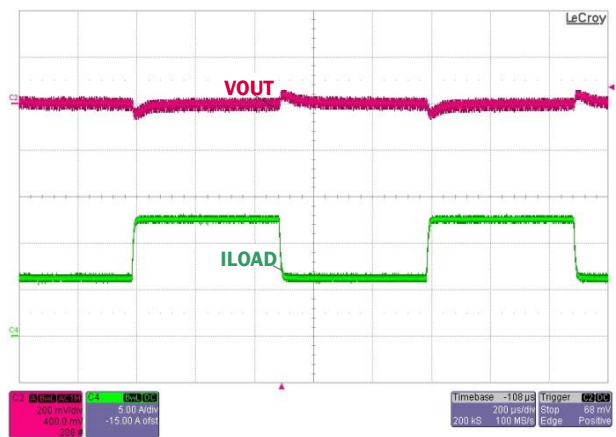

FIGURE 9. LOAD TRANSIENT (25% TO 50% AT 2A/ μ s)

ISL8130EVAL2Z Schematic

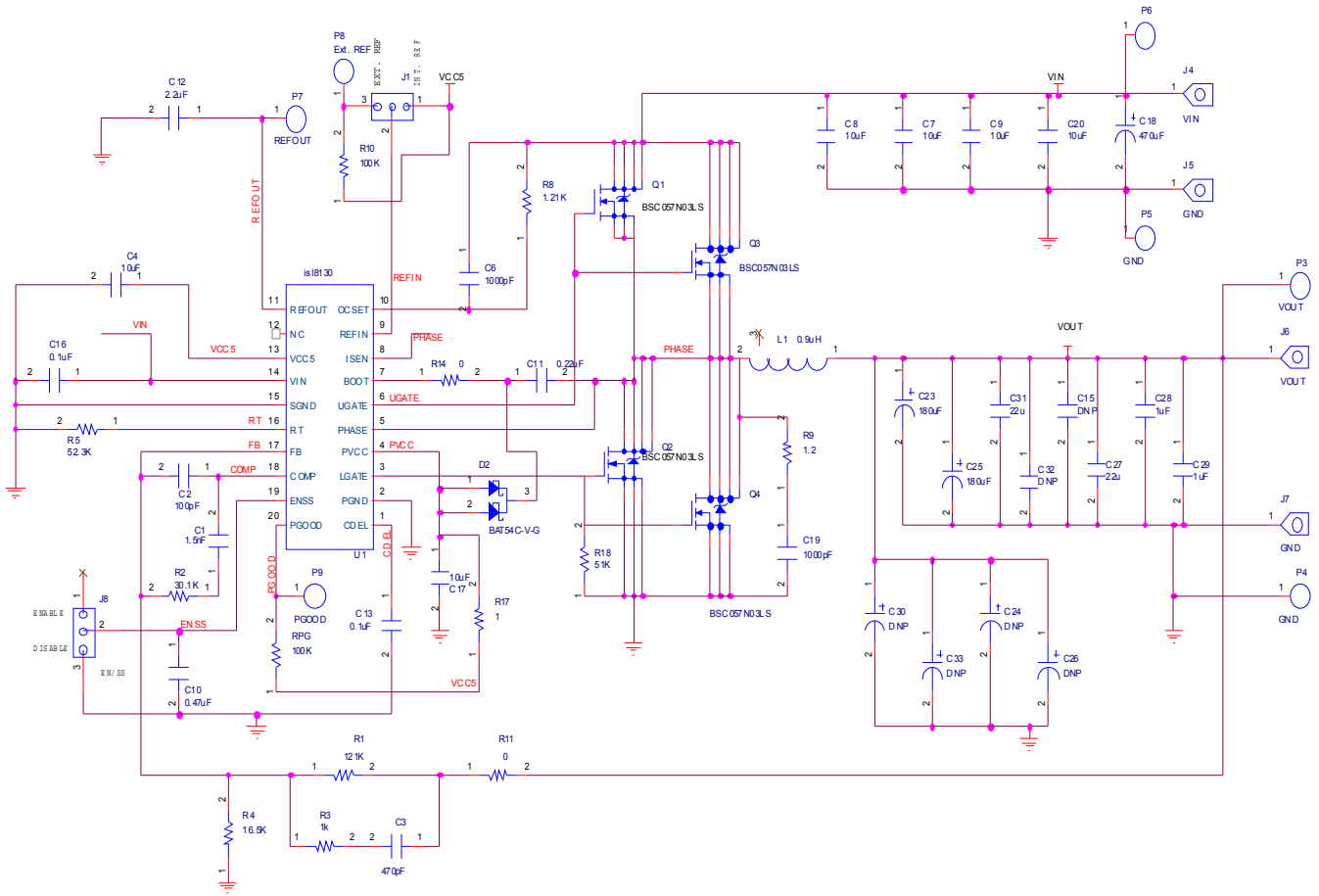

TABLE 3. ISL8130EVAL2Z BILL OF MATERIALS

ITEM	QTY	PART REFERENCE	VALUE	DESCRIPTION	PART NUMBER	MANUFACTURER
ESSENTIAL COMPONENTS						
1	1	C3	470pF	Ceramic CAP, NPO or COG, sm0603	GENERIC	GENERIC
2	2	C13, C16	0.1μF	Ceramic CAP, X5R, 50V, sm0603	GENERIC	GENERIC
3	2	C4, C17	10μF	Ceramic CAP, X5R, 10V, sm0805	GENERIC	GENERIC
4	1	C10	0.47μF	Ceramic CAP, X5R, 16V, sm0603	GENERIC	GENERIC
5	3	C27, C31	22μF	Ceramic CAP, X5R, 25V, sm1210	GENERIC	GENERIC
6	1	C12	2.2μF	Ceramic CAP, X5R, 16V, sm0603	GENERIC	GENERIC
7	2	C6, C19	1000pF	Ceramic CAP, NPO or COG, sm0603	GENERIC	GENERIC
8	2	C23, C25	180μF	OSCON, 16V, Radial 8x9	16SEPC180MX	SANYO
9	4	C7, C8, C9, C20	10μF	Ceramic CAP, X5R, 25V, sm1210	GENERIC	GENERIC
10	1	C2	100pF	Ceramic CAP, NPO or COG, sm0603	GENERIC	GENERIC
11	2	C28, C29	1μF	Ceramic CAP, X5R, 25V, sm0603	GENERIC	GENERIC
12	1	C1	1500pF	Ceramic CAP, NPO or COG, sm0603	GENERIC	GENERIC
13	1	C11	0.22μF	Ceramic CAP, X5R, 16V, sm0603	GENERIC	GENERIC
14	1	C18	470μF	Alum. Cap, 50V	16SVPE470M	SANYO
15	1	D2		Schottky Diode, 30V, SOT23	BAT54C	Fairchild
16	1	L1	0.9μH	Inductor	SER2010-901ML	Coilcraft
17	4	Q1, Q2, Q3, Q4		Single Channel NFET, 30V	BSC057N03LS G	Infineon
18	1	R5	52.3k	Resistor, sm0603, 1%	GENERIC	GENERIC
19	1	R9	1.2	Resistor, sm0603, 10%	GENERIC	GENERIC
20	1	R2	30.1k	Resistor, sm0603, 1%	GENERIC	GENERIC
21	2	R11, R14	0	Resistor, sm0603, 10%	GENERIC	GENERIC
22	1	R4	16.5k	Resistor, sm0603, 1%	GENERIC	GENERIC
23	1	R17	1	Resistor, sm0603, 10%	GENERIC	GENERIC
24	1	R18	51k	Resistor, sm0603, 1%	GENERIC	GENERIC
25	1	R1	121k	Resistor, sm0603, 1%	GENERIC	GENERIC
26	1	R8	1.21k	Resistor, sm0603, 1%	GENERIC	GENERIC
27	1	R3	1k	Resistor, sm0603, 1%	GENERIC	GENERIC
28	2	R10, RPG	100k	Resistor, sm0603, 1%	GENERIC	GENERIC
29	1	U1		PWM CONTROLLER, 20 Ld QSOP	ISL8130IAZ	INTERSIL
OPTIONAL COMPONENTS						
30	6	C15, C24, C26, C30, C32, C33	DO NOT POPULATE			
EVALUATION HARDWARE						
31	4	J4, J5, J6, J7		HARDWARE, MTG, CABLE TERMINAL, 6-14AWG, LUG&SCRE , ROHS	KPA8CTP	BERG/FCI
32	2	J1, J8		1x3 Header	GENERIC	GENERIC
33	7	P3, P4, P5, P6, P7, P8, P9		Test Points	1514-2	Keystone

ISL8130EVAL2Z PCB Layout

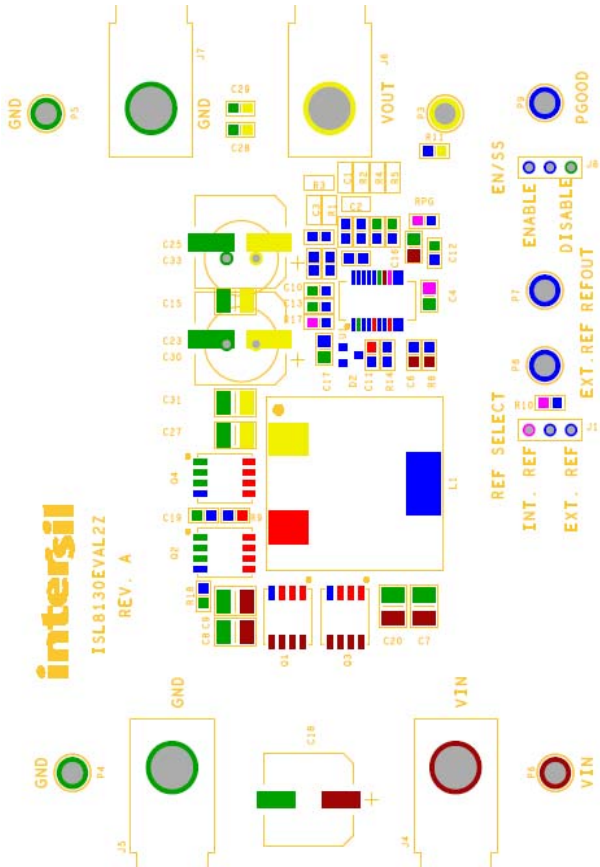

FIGURE 10. TOP SILKSCREEN

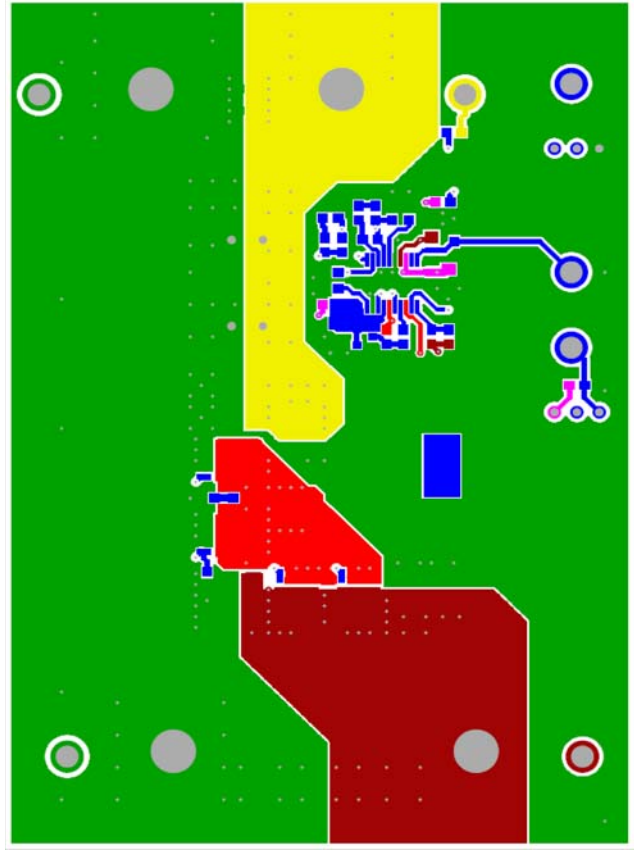

FIGURE 11. TOP LAYER

ISL8130EVAL2Z PCB Layout (Continued)

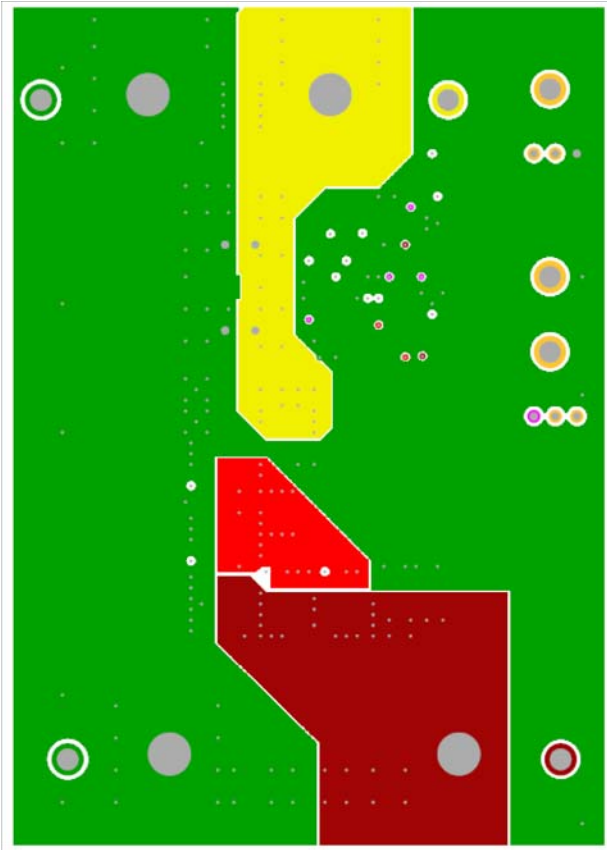

FIGURE 14. BOTTOM LAYER

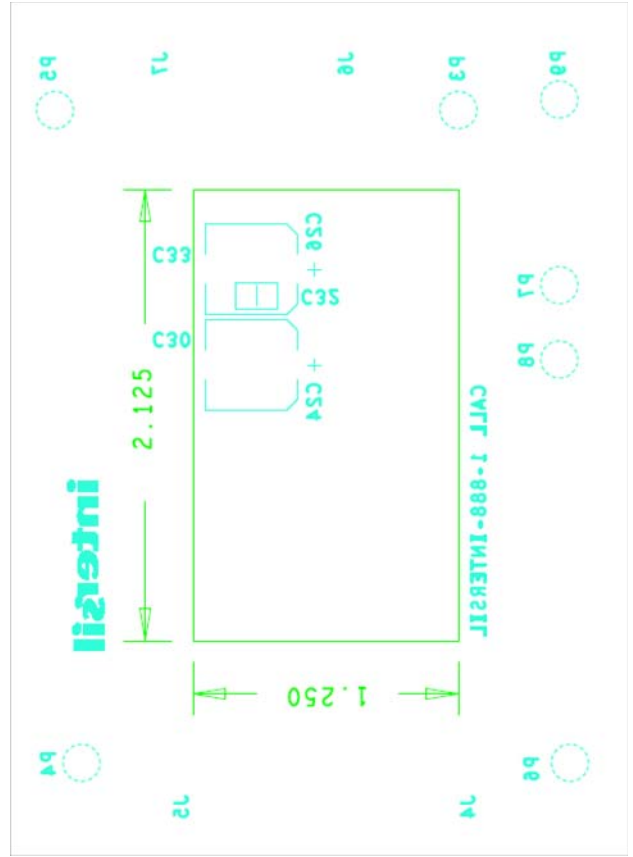

FIGURE 15. BOTTOM SILKSCREEN

Notice

1. Descriptions of circuits, software and other related information in this document are provided only to illustrate the operation of semiconductor products and application examples. You are fully responsible for the incorporation or any other use of the circuits, software, and information in the design of your product or system. Renesas Electronics disclaims any and all liability for any losses and damages incurred by you or third parties arising from the use of these circuits, software, or information.
2. Renesas Electronics hereby expressly disclaims any warranties against and liability for infringement or any other claims involving patents, copyrights, or other intellectual property rights of third parties, by or arising from the use of Renesas Electronics products or technical information described in this document, including but not limited to, the product data, drawings, charts, programs, algorithms, and application examples.
3. No license, express, implied or otherwise, is granted hereby under any patents, copyrights or other intellectual property rights of Renesas Electronics or others.
4. You shall not alter, modify, copy, or reverse engineer any Renesas Electronics product, whether in whole or in part. Renesas Electronics disclaims any and all liability for any losses or damages incurred by you or third parties arising from such alteration, modification, copying or reverse engineering.
5. Renesas Electronics products are classified according to the following two quality grades: "Standard" and "High Quality". The intended applications for each Renesas Electronics product depends on the product's quality grade, as indicated below.
"Standard": Computers; office equipment; communications equipment; test and measurement equipment; audio and visual equipment; home electronic appliances; machine tools; personal electronic equipment; industrial robots; etc.
"High Quality": Transportation equipment (automobiles, trains, ships, etc.); traffic control (traffic lights); large-scale communication equipment; key financial terminal systems; safety control equipment; etc.
Unless expressly designated as a high reliability product or a product for harsh environments in a Renesas Electronics data sheet or other Renesas Electronics document, Renesas Electronics products are not intended or authorized for use in products or systems that may pose a direct threat to human life or bodily injury (artificial life support devices or systems; surgical implantations; etc.), or may cause serious property damage (space system; undersea repeaters; nuclear power control systems; aircraft control systems; key plant systems; military equipment; etc.). Renesas Electronics disclaims any and all liability for any damages or losses incurred by you or any third parties arising from the use of any Renesas Electronics product that is inconsistent with any Renesas Electronics data sheet, user's manual or other Renesas Electronics document.
6. When using Renesas Electronics products, refer to the latest product information (data sheets, user's manuals, application notes, "General Notes for Handling and Using Semiconductor Devices" in the reliability handbook, etc.), and ensure that usage conditions are within the ranges specified by Renesas Electronics with respect to maximum ratings, operating power supply voltage range, heat dissipation characteristics, installation, etc. Renesas Electronics disclaims any and all liability for any malfunctions, failure or accident arising out of the use of Renesas Electronics products outside of such specified ranges.
7. Although Renesas Electronics endeavors to improve the quality and reliability of Renesas Electronics products, semiconductor products have specific characteristics, such as the occurrence of failure at a certain rate and malfunctions under certain use conditions. Unless designated as a high reliability product or a product for harsh environments in a Renesas Electronics data sheet or other Renesas Electronics document, Renesas Electronics products are not subject to radiation resistance design. You are responsible for implementing safety measures to guard against the possibility of bodily injury, injury or damage caused by fire, and/or danger to the public in the event of a failure or malfunction of Renesas Electronics products, such as safety design for hardware and software, including but not limited to redundancy, fire control and malfunction prevention, appropriate treatment for aging degradation or any other appropriate measures. Because the evaluation of microcomputer software alone is very difficult and impractical, you are responsible for evaluating the safety of the final products or systems manufactured by you.
8. Please contact a Renesas Electronics sales office for details as to environmental matters such as the environmental compatibility of each Renesas Electronics product. You are responsible for carefully and sufficiently investigating applicable laws and regulations that regulate the inclusion or use of controlled substances, including without limitation, the EU RoHS Directive, and using Renesas Electronics products in compliance with all these applicable laws and regulations. Renesas Electronics disclaims any and all liability for damages or losses occurring as a result of your noncompliance with applicable laws and regulations.
9. Renesas Electronics products and technologies shall not be used for or incorporated into any products or systems whose manufacture, use, or sale is prohibited under any applicable domestic or foreign laws or regulations. You shall comply with any applicable export control laws and regulations promulgated and administered by the governments of any countries asserting jurisdiction over the parties or transactions.
10. It is the responsibility of the buyer or distributor of Renesas Electronics products, or any other party who distributes, disposes of, or otherwise sells or transfers the product to a third party, to notify such third party in advance of the contents and conditions set forth in this document.
11. This document shall not be reprinted, reproduced or duplicated in any form, in whole or in part, without prior written consent of Renesas Electronics.
12. Please contact a Renesas Electronics sales office if you have any questions regarding the information contained in this document or Renesas Electronics products.
(Note 1) "Renesas Electronics" as used in this document means Renesas Electronics Corporation and also includes its directly or indirectly controlled subsidiaries.
(Note 2) "Renesas Electronics product(s)" means any product developed or manufactured by or for Renesas Electronics.

(Rev.4.0-1 November 2017)



SALES OFFICES

Renesas Electronics Corporation

<http://www.renesas.com>

Refer to "<http://www.renesas.com/>" for the latest and detailed information.

Renesas Electronics America Inc.
1001 Murphy Ranch Road, Milpitas, CA 95035, U.S.A.
Tel: +1-408-432-8888, Fax: +1-408-434-5351

Renesas Electronics Canada Limited
9251 Yonge Street, Suite 8309 Richmond Hill, Ontario Canada L4C 9T3
Tel: +1-905-237-2004

Renesas Electronics Europe Limited
Dukes Meadow, Millboard Road, Bourne End, Buckinghamshire, SL8 5FH, U.K
Tel: +44-1628-651-700, Fax: +44-1628-651-804

Renesas Electronics Europe GmbH
Arcadiastrasse 10, 40472 Düsseldorf, Germany
Tel: +49-211-6503-0, Fax: +49-211-6503-1327

Renesas Electronics (China) Co., Ltd.
Room 1709 Quantum Plaza, No.27 ZhichunLu, Haidian District, Beijing, 100191 P. R. China
Tel: +86-10-8235-1155, Fax: +86-10-8235-7679

Renesas Electronics (Shanghai) Co., Ltd.
Unit 301, Tower A, Central Towers, 555 Langao Road, Putuo District, Shanghai, 200333 P. R. China
Tel: +86-21-2226-0888, Fax: +86-21-2226-0999

Renesas Electronics Hong Kong Limited
Unit 1601-1611, 16/F., Tower 2, Grand Century Place, 193 Prince Edward Road West, Mongkok, Kowloon, Hong Kong
Tel: +852-2265-6688, Fax: +852-2886-9022

Renesas Electronics Taiwan Co., Ltd.
13F, No. 363, Fu Shing North Road, Taipei 10543, Taiwan
Tel: +886-2-8175-9600, Fax: +886-2-8175-9670

Renesas Electronics Singapore Pte. Ltd.
80 Bendemeer Road, Unit #06-02 Hyflux Innovation Centre, Singapore 339949
Tel: +65-6213-0200, Fax: +65-6213-0300

Renesas Electronics Malaysia Sdn.Bhd.
Unit 1207, Block B, Menara Amcorp, Amcorp Trade Centre, No. 18, Jln Persiaran Barat, 46050 Petaling Jaya, Selangor Darul Ehsan, Malaysia
Tel: +60-3-7955-9390, Fax: +60-3-7955-9510

Renesas Electronics India Pvt. Ltd.
No.777C, 100 Feet Road, HAL 2nd Stage, Indiranagar, Bangalore 560 038, India
Tel: +91-80-67208700, Fax: +91-80-67208777

Renesas Electronics Korea Co., Ltd.
17F, KAMCO Yangjae Tower, 262, Gangnam-daero, Gangnam-gu, Seoul, 06265 Korea
Tel: +82-2-558-3737, Fax: +82-2-558-5338