



# MZT8-2V6PSAKRD

MZT8 VIA

SENSORS FOR T-SLOT CYLINDERS

**SICK**  
Sensor Intelligence.



### Ordering information

| Type           | Part no. |
|----------------|----------|
| MZT8-2V6PSAKRD | 1083800  |

Other models and accessories → [www.sick.com/MZT8\\_VIA](http://www.sick.com/MZT8_VIA)



### Detailed technical data

#### Features

|                                    |   |
|------------------------------------|---|
| <b>Cylinder type</b>               | T-slot  |
| <b>Cylinder types with adapter</b> | Profile cylinder<br>Tie rod cylinder<br>Round body cylinder<br>Dovetail groove cylinder<br>SMC rail CDQ2<br>SMC rail ECDQ2                          |
| <b>Housing length</b>              | 24 mm   |
| <b>Switching output</b>            | PNP   |
| <b>Switching frequency</b>         | 1,000 Hz  |
| <b>Output function</b>             | NO  |
| <b>Electrical wiring</b>           | DC 3-wire   |
| <b>Enclosure rating</b>            | IP68 <sup>1) 2)</sup>   |
| <b>Special features</b>            | Visual installation aid/LED indicator (yellow)<br>Power LED (green)<br>Interior housing temperature (via IO-Link)<br>Counter function (via IO-Link) |

<sup>1)</sup> According to EN 60529 (IP 67 / IP 68).

<sup>2)</sup> According to DIN 40050 (IP 69K).

#### Mechanics/electronics

|                          |                     |
|--------------------------|---------------------|
| <b>Supply voltage</b>    | 10 V DC ... 30 V DC |
| <b>Power consumption</b> | 10 mA <sup>1)</sup> |
| <b>Voltage drop</b>      | ≤ 2.2 V             |

<sup>1)</sup> Without load.

<sup>2)</sup> U<sub>b</sub> and T<sub>a</sub> constant.

<sup>3)</sup> PVC-cable without UL-Certificate.

|   |   |
|---|---|
| <b>Continuous current I<sub>a</sub></b> | ≤ 200 mA  |
| <b>Protection class</b>                 | III   |
| <b>Response sensitivity, typ.</b>       | 2.6 mT  |
| <b>Overrun distance, typ.</b>           | 3 mm  |
| <b>Hysteresis, typ.</b>                 | 0.7 mT  |
| <b>Reproducibility</b>                  | ≤ 0.1 mT <sup>2)</sup>  |
| <b>Reverse polarity protection</b>      | ✓   |
| <b>Short-circuit protection</b>         | ✓   |
| <b>Power-up pulse protection</b>        | ✓   |
| <b>Ambient operating temperature</b>    | -30 °C ... +80 °C   |
| <b>Shock and vibration resistance</b>   | 30 g, 11 ms / 10 ... 55 Hz, 1 mm  |
| <b>EMC</b>                              | According to EN 60947-5-2   |
| <b>Connection type</b>                  | Cable with connector M8, 3-pin, with knurled nuts, drag chain use, 0.3 m  |
| <b>Connection type Detail</b>           |   |
| Conductor cross-section                 | 0.14 mm <sup>2</sup>  |
| Cable diameter                          | Ø 2.9 mm  |
| Bending radius                          | With fixed installation > 3 x cable diameter<br>For flexible use > 10 x cable diameter  |
| Torsion force                           | ± 270° / 10 cm  |
| Torsion cycles                          | > 2,000,000   |
| Cable outlet                            | Axial   |
| <b>Material</b>                         |   |
| Housing                                 | Plastic, PA12   |
| Cable                                   | PUR <sup>3)</sup>   |
| <b>Special features</b>                 | Visual installation aid/LED indicator (yellow), Power LED (green), interior housing temperature (via IO-Link), counter function (via IO-Link) |
| <b>UL File No.</b>                      | NRKH.E181493 & NRKH7.E181493  |

1) Without load.

2) U<sub>b</sub> and T<sub>a</sub> constant.

3) PVC-cable without UL-Certificate.

## Communication interface

|                                       |   |
|---------------------------------------|---|
| <b>Communication interface</b>        | IO-Link V1.0  |
| <b>Communication Interface detail</b> | COM2 (38,4 kBaud)   |
| <b>Cycle time</b>                     | 10.4 ms   |
| <b>Process data length</b>            | 8 Bit   |
| <b>Process data structure</b>         | Bit 0 = switching signal Q <sub>L1</sub><br>Bit 1 = switching signal Q <sub>L2</sub><br>Bit 2 ... 7 = empty |
| <b>VendorID</b>                       | 26  |
| <b>DeviceID HEX</b>                   | 0x80015D  |
| <b>DeviceID DEC</b>                   | 8388957   |

## Classifications

|                   |          |
|-------------------|----------|
| <b>ECI@ss 5.0</b> | 27270104 |
|-------------------|----------|

|                       |          |
|-----------------------|----------|
| <b>ECl@ss 5.1.4</b>   | 27270104 |
| <b>ECl@ss 6.0</b>     | 27270104 |
| <b>ECl@ss 6.2</b>     | 27270104 |
| <b>ECl@ss 7.0</b>     | 27270104 |
| <b>ECl@ss 8.0</b>     | 27270104 |
| <b>ECl@ss 8.1</b>     | 27270104 |
| <b>ECl@ss 9.0</b>     | 27270104 |
| <b>ECl@ss 10.0</b>    | 27270104 |
| <b>ECl@ss 11.0</b>    | 27270104 |
| <b>ETIM 5.0</b>       | EC002544 |
| <b>ETIM 6.0</b>       | EC002544 |
| <b>ETIM 7.0</b>       | EC002544 |
| <b>UNSPSC 16.0901</b> | 39122230 |

### Installation note

Visual installation aid  
(yellow LED)

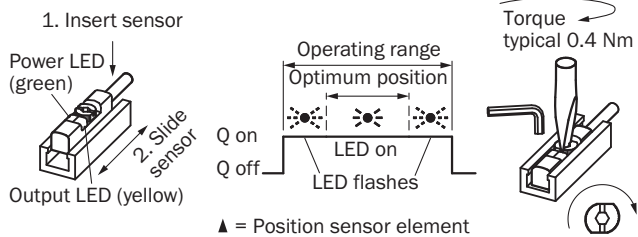

### Connection diagram

Cd-401

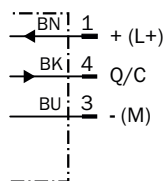

**Dimensional drawing** (Dimensions in mm (inch))

Cable with connector M8, with knurled nuts

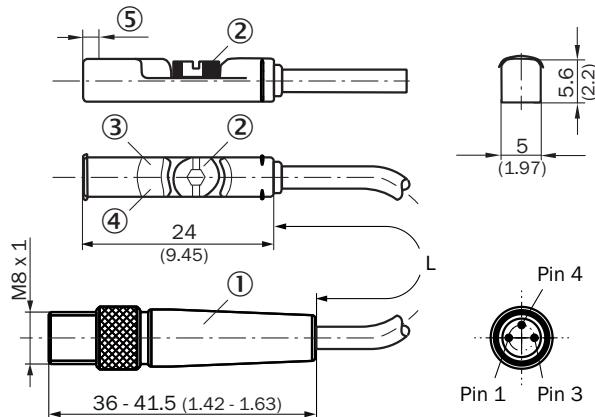





- ① Connection
- ② Fixing screw SW 2.0
- ③ Visual installation aid/LED indicator (yellow)
- ④ Power LED (green)
- ⑤ Sensor element position; short overrun distance (3 mm): 2 mm, long overrun distance (9 mm): 1.7 mm

| Part no. | Type           | L      | Number of cores |
|----------|----------------|--------|-----------------|
| 1083800  | MZT8-2V6PSAKRD | 300 mm | 3               |
| 1082456  | MZT8-2V6PSAKR0 | 500 mm | 3               |

**Recommended accessories**

Other models and accessories → [www.sick.com/MZT8\\_VIA](http://www.sick.com/MZT8_VIA)

|                                      | Brief description   | Type          | Part no. |
|--------------------------------------|---|---------------|----------|
| <b>Brackets for cylinder sensors</b> |   |               |          |
|                                      | Mounting bracket for cylinder with dovetail slot, Aluminum, without mounting hardware   | BEF-KHZ-ST1   | 2022703  |
|                                      | Mounting bracket for integrated profile cylinder/tie-rod cylinder, zinc diecast, mounting hardware included                               | BEF-KHZ-PT1   | 2022702  |
|                                      | 1 piece, Mounting bracket on round body cylinder with piston diameter of 12 mm, ambient temperature min 0 °C max 50 °C, plastic, Aluminum | BEF-KHZ-RT-12 | 2077681  |
|                                      | 1 piece, Mounting bracket on round body cylinder with piston diameter of 16 mm, ambient temperature min 0 °C max 50 °C, plastic, Aluminum | BEF-KHZ-RT-16 | 2077680  |
|                                      | 1 piece, Mounting bracket on round body cylinder with piston diameter of 20 mm, ambient temperature min 0 °C max 50 °C, plastic, Aluminum | BEF-KHZ-RT-20 | 2077679  |
|                                      | 1 piece, Mounting bracket on round body cylinder with piston diameter of 25 mm, ambient temperature min 0 °C max 50 °C, plastic, Aluminum | BEF-KHZ-RT-25 | 2077678  |
|                                      | 1 piece, Mounting bracket on round body cylinder with piston diameter of 32 mm, ambient temperature min 0 °C max 50 °C, plastic, Aluminum | BEF-KHZ-RT-32 | 2077677  |
|                                      | 1 piece, Mounting bracket on round body cylinder with piston diameter of 40 mm, ambient temperature min 0 °C max 50 °C, plastic, Aluminum | BEF-KHZ-RT-40 | 2077676  |

|   | Brief description  | Type            | Part no. |
|---|--|-----------------|----------|
|  | 1 piece, Mounting bracket on round body cylinder with piston diameter of 50 mm, ambient temperature min 0 °C max 50 °C, plastic, Aluminum                      | BEF-KHZ-RT-50   | 2077675  |
|   | 1 piece, Mounting bracket on round body cylinder with piston diameter of 63 mm, ambient temperature min 0 °C max 50 °C, plastic, Aluminum                      | BEF-KHZ-RT-63   | 2077674  |
|   | 1 piece, Mounting bracket on round body cylinder with piston diameter of 8 mm ... 130 mm, ambient temperature min -30 °C max 80 °C, stainless steel, Zinc cast | BEF-KHZ-RT1-130 | 2077684  |
|   | 1 piece, Mounting bracket on round body cylinder with piston diameter of 8 mm ... 25 mm, ambient temperature min -30 °C max 80 °C, stainless steel, Zinc cast  | BEF-KHZ-RT1-25  | 2077682  |
|   | 1 piece, Mounting bracket on round body cylinder with piston diameter of 8 mm ... 63 mm, ambient temperature min -30 °C max 80 °C, stainless steel, Zinc cast  | BEF-KHZ-RT1-63  | 2077683  |
|  | Mounting bracket for mounting on SMC rails CDQ2 (T-slot), Aluminum, without mounting hardware  | BEF-KHZ-TT2     | 2046440  |
|  | Mounting bracket for mounting on SMC rails ECDQ2 (T-slot), Aluminum, without mounting hardware   | BEF-KHZ-TT1     | 2046439  |
| Device protection (mechanical)  |  |                 |          |
|  | Protective adapter, die-cast zinc, mounting hardware included  | BEF-SG-MRZT     | 2077201  |

### Recommended services

Additional services → [www.sick.com/MZT8\\_VIA](http://www.sick.com/MZT8_VIA)

|   | Type                   | Part no.   |
|---|------------------------|------------|
| Function Block Factory  |                        |            |
| <ul style="list-style-type: none"> <li><b>Description:</b> The Function Block Factory supports common programmable logic controllers (PLCs) from various manufacturers, such as Siemens, Beckhoff, Rockwell Automation and B&amp;R. More information on the FBF can be found <a _blank"="" href="https://fbf.cloud.sick.com target=">here</a>.</li> </ul> | Function Block Factory | On request |

## SICK AT A GLANCE

SICK is one of the leading manufacturers of intelligent sensors and sensor solutions for industrial applications. A unique range of products and services creates the perfect basis for controlling processes securely and efficiently, protecting individuals from accidents and preventing damage to the environment.

We have extensive experience in a wide range of industries and understand their processes and requirements. With intelligent sensors, we can deliver exactly what our customers need. In application centers in Europe, Asia and North America, system solutions are tested and optimized in accordance with customer specifications. All this makes us a reliable supplier and development partner.

Comprehensive services complete our offering: SICK LifeTime Services provide support throughout the machine life cycle and ensure safety and productivity.

For us, that is “Sensor Intelligence.”

## WORLDWIDE PRESENCE:

Contacts and other locations –[www.sick.com](http://www.sick.com)