

## DETAILS

<b>Product Number</b>	CS14130_HB-IP-2X6-W
<b>Family</b>	High Bay
<b>Type</b>	Assembly
<b>Color</b>	white
<b>Diameter</b>	173 + 71.4 mm
<b>Height</b>	11.4 mm
<b>Style</b>	rectang
<b>Optic Material</b>	PMMA
<b>Holder Material</b>	
<b>Fastening</b>	screw, pin
<b>Status</b>	ready
<b>ROHS Compliant</b>	Yes
<b>Date Updated</b>	4/12/2014



## OPTICAL PROPERTIES

LED	Viewing	Light	Effi-		Connector
	Angle	Beam	ciency	cd/lm	
Acrich MJT 4040	sim: 52	Wide	sim: 93 %	sim: 0.000	-
XP-E2	sim: 56	Wide	sim: 94 %	sim: 0.000	-
TL1L3	sim: 54	Wide	sim: 89 %	sim: 0.000	-
TL1L2	sim: 55	Wide	sim: 94 %	sim: 0.980	-
Duris S8	sim: 56	Wide	sim: 95 %	sim: 1.140	-
XM-L	sim: 57	Wide	sim: 93 %	sim: 0.000	-
Oslon Square PC	sim: 56	Wide	sim: 93 %	sim: 0.000	-
Oslon Square EC	sim: 56	Wide	sim: 93 %	sim: 0.000	-
LUXEON Rebel	sim: 50	Wide	sim: 93 %	sim: 0.000	-
NVSxx19B/NVSxx19C	sim: 54	Wide	sim: 91 %	sim: 0.000	-
NF2x757A	sim: 50	Wide	sim: 93 %	sim: 0.000	-
XB-D	sim: 52	Wide	sim: 90 %	sim: 0.000	-
LUXEON Z ES	52 deg	Wide	94 %	1.000	-
LUXEON TX	54 deg	Wide	94 %	0.960	-
TL1L4	56 deg	Wide	94 %	0.950	-
LUXEON Rebel ES	57 deg	Wide	94 %	0.860	-
XT-E	58 deg	Wide	94 %	0.870	-
XP-G2	58 deg	Wide	93 %	0.870	-
LUXEON R	58 deg	Wide	94 %	0.900	-
Z5M1/Z5M2	59 deg	Wide	94 %	0.870	-
XP-G	60 deg	Wide	94 %	0.840	-
LUXEON T	60 deg	Wide	94 %	0.860	-
XM-L2	61 deg	Wide	94 %	0.800	-
XP-L	67 deg	Wide	94 %	0.750	-

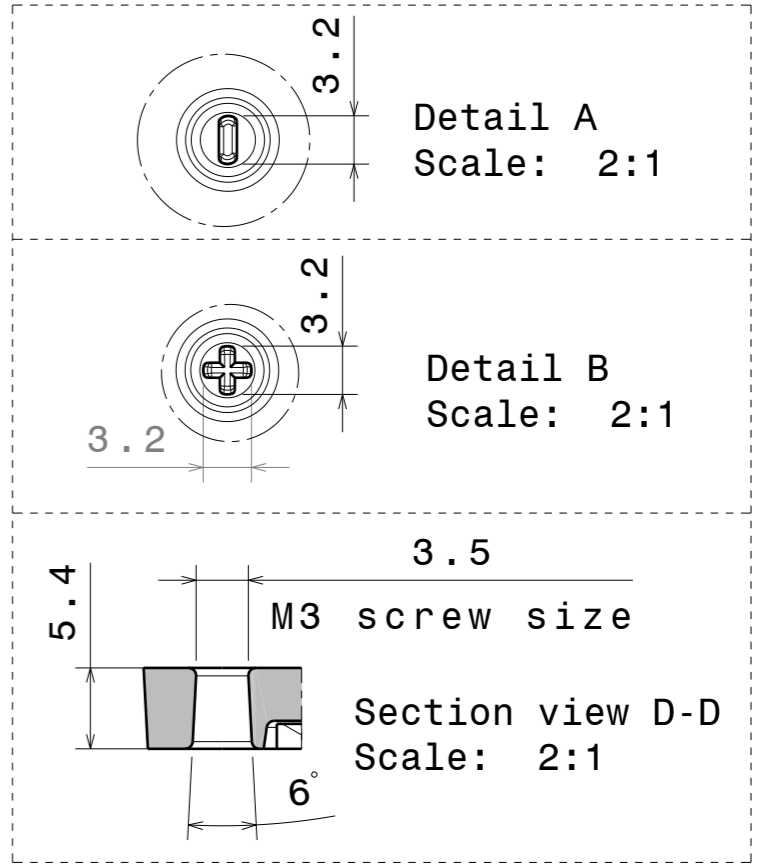
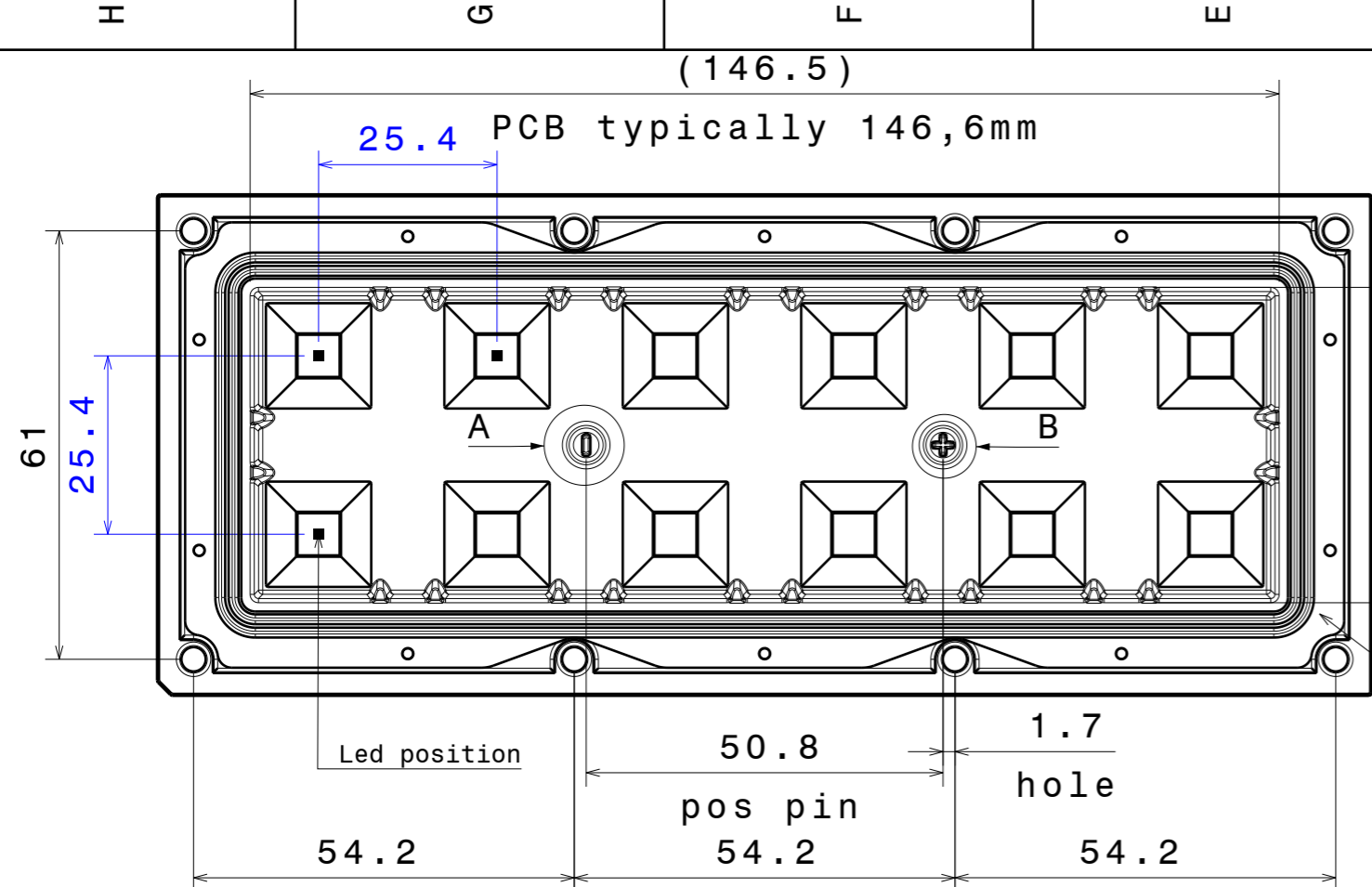

Wiring:  
PCB is fully sealed between the lens with silicone seal and the heatsink. Wiring needs to be done through the PCB and heat sink to maintain high IP rating.

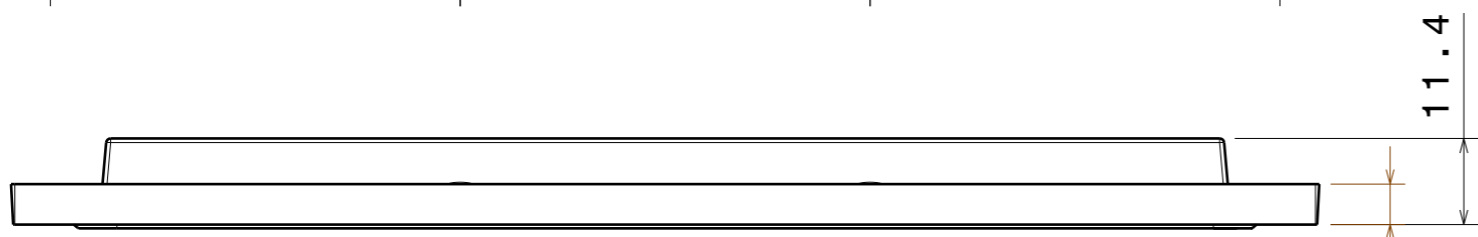

Fasten middle screws first. Recommended torque with pan head screw: 0.57Nm (for 1.6mm thick PCB, no thermal pad)

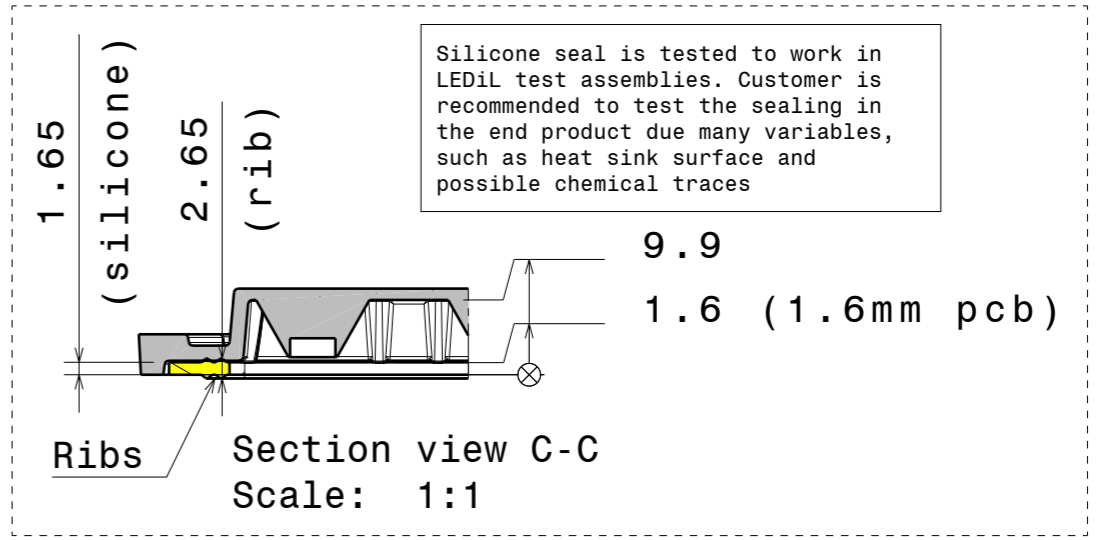
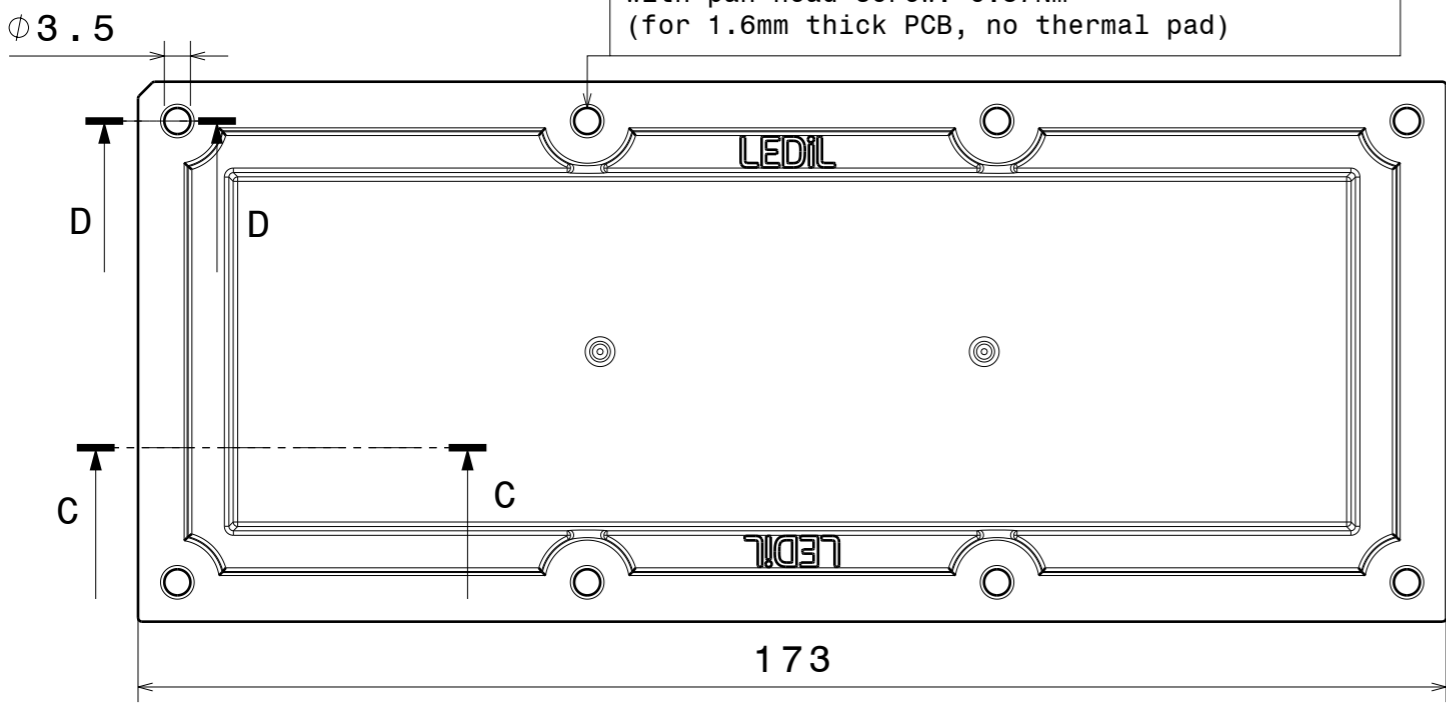

Silicone seal is tested to work in LEDiL test assemblies. Customer is recommended to test the sealing in the end product due many variables, such as heat sink surface and possible chemical traces

INDEX	PART NO	DESCRIPTION	MATERIAL	COLOUR
1	CS14130	HB-IP-2x6-W	PMMA 8N, Silicone seal	

Tolerances if not otherwise shown  
According to DIN ISO 2768-1  
Linear measures:  
Up to 30mm class M, otherwise class C.  
According to DIN ISO 2768-2  
Form and position: class L

**LEDiL**  
Ledil Oy  
Salorankatu 10  
FIN 24240 SALO  
Finland

THIRD ANGLE PROJECTION:

DRAWING TITLE  
**CS14130\_HB-IP-2x6-W**

This drawing is the property of LEDiL Oy. It may not be reproduced, copied or communicated without a written agreement with LEDiL Oy."

SIZE	PART NUMBER
<b>A3</b>	<b>CS14130</b>

SCALE	1:1	WEIGHT		SHEET	1/1
-------	-----	--------	--	-------	-----



Luminaire: LEDiL Oy CS14130\_HB-IP-2X6-W\_(LUXEON\_Z\_ES) Eff.94.0%  
Lamps: 1 x LUXEON\_Z\_ES\_990.2lm@250mA\_P=8.31159W\_I=249.8mA

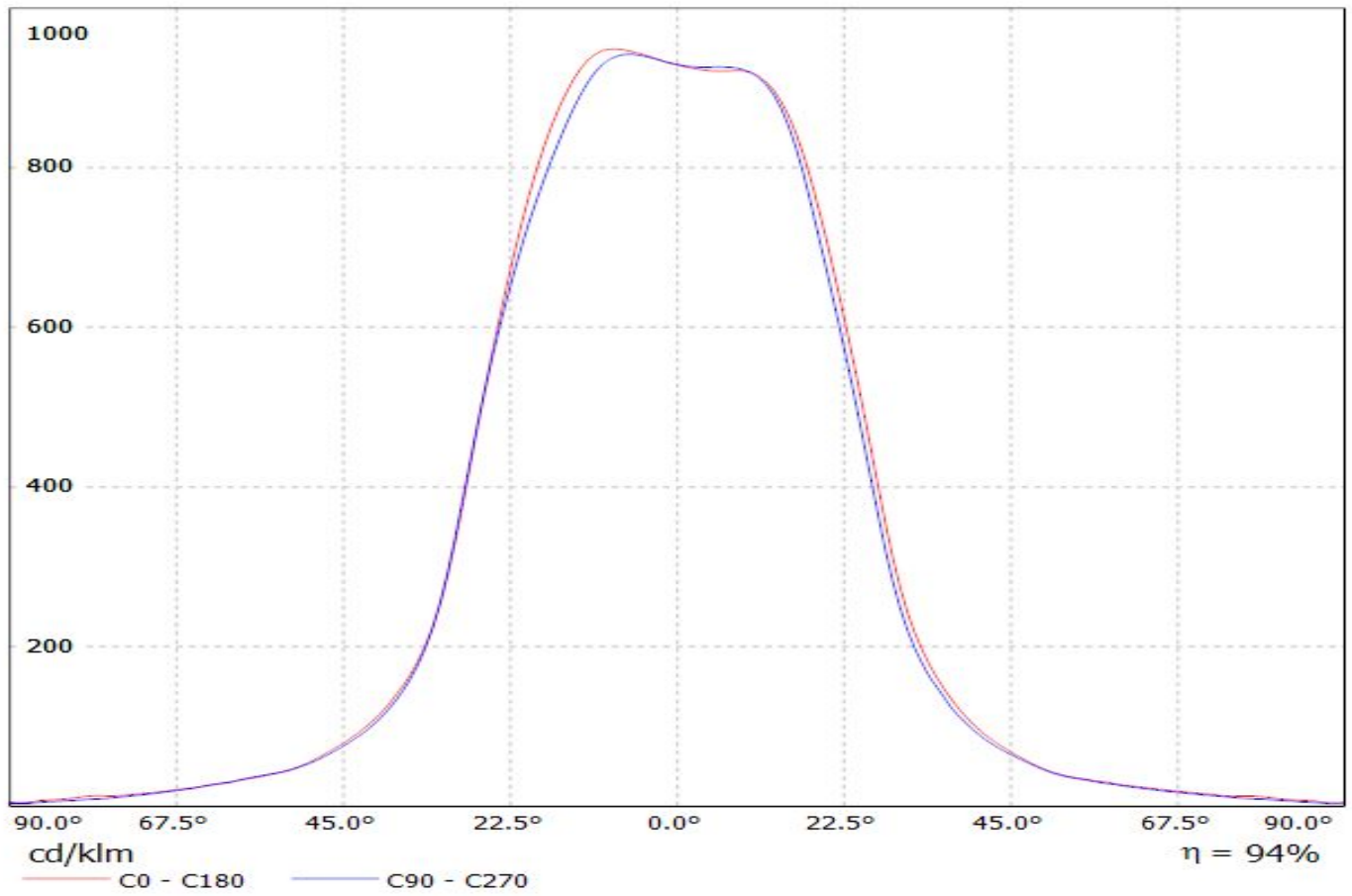

Luminaire: LEDiL Oy CS14130\_HB-IP-2X6-W\_(Luxeon\_TX)  
Lamps: 1 x Luxeon\_TX\_2x6\_1301.4lm@250mA\_P=8.26138W\_I=249.8mA

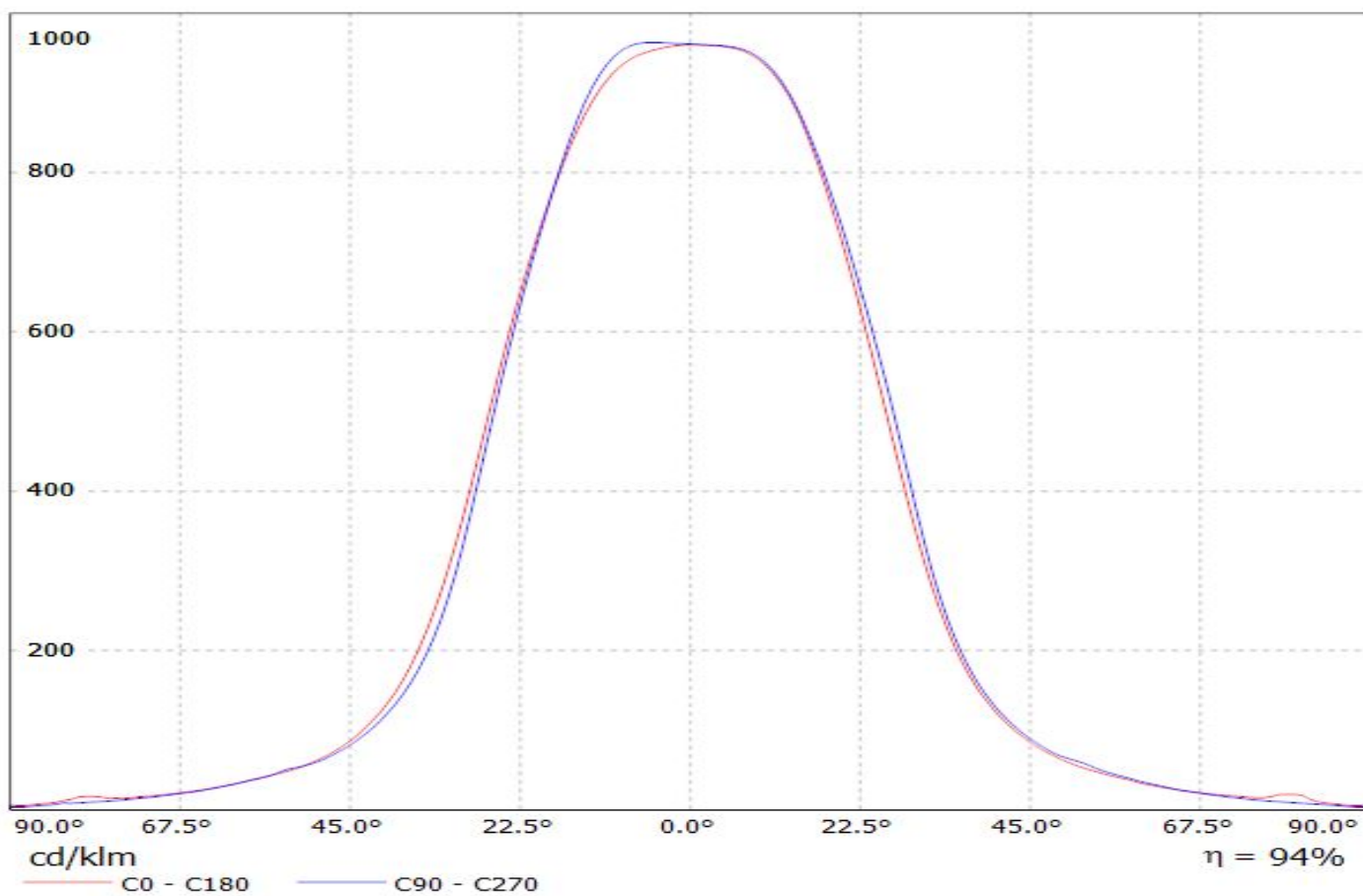

# Ledil CS14130\_HB-IP-2X6-W\_(TL1L4) / LDC (Linear)

Luminaire: Ledil CS14130\_HB-IP-2X6-W\_(TL1L4)

Lamps: 1 x Toshiba\_TL1L4\_2x6\_(TL1L4-DW0)\_1263.19lm@250mA\_CCT=6500K\_P=8.5W\_I=0.25A

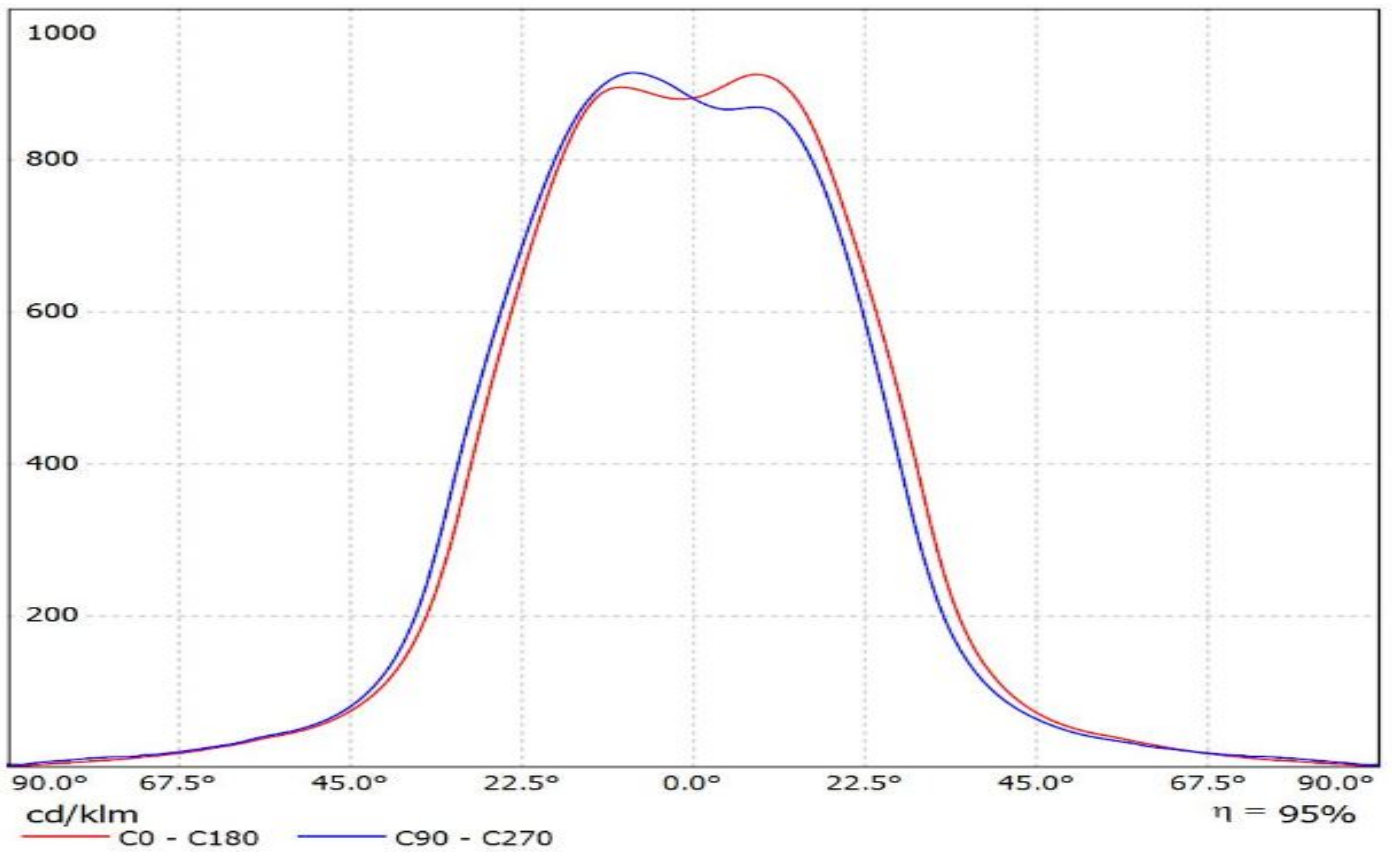

Luminaire: LEDiL Oy CS14130\_HB-IP-2X6-W\_(REBEL-ES) Eff.94.0%  
Lamps: 1 x Luxeon\_Rebel-ES\_2x6\_864.2lm@250mA\_P=9.03127W\_I=249.8mA

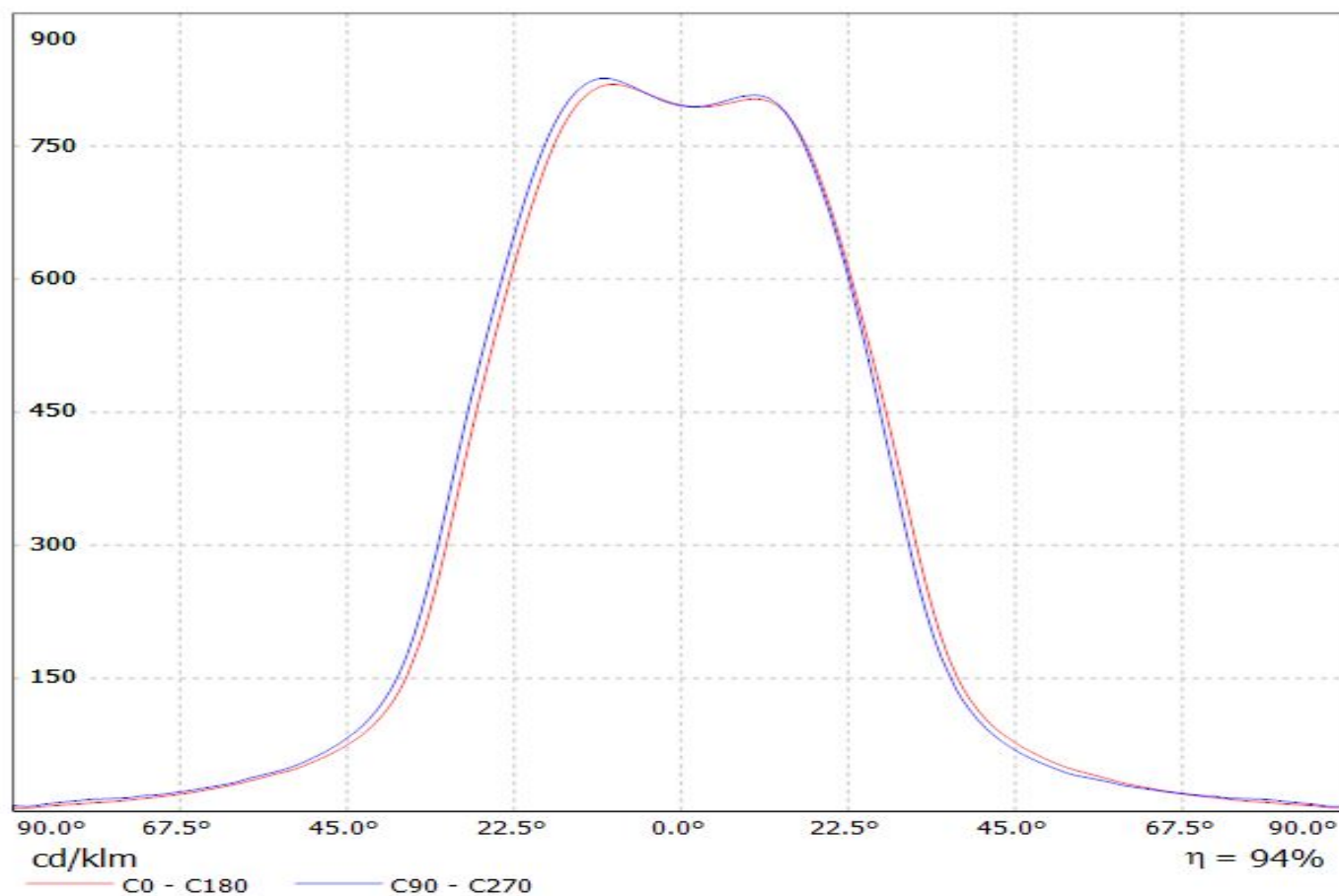

Luminaire: LEDiL Oy CS14130\_HB-IP-2X6-W\_(XT-E)

Lamps: 1 x CREE\_XT-E\_6x2\_(XTEAWT-00-0000-000000HE4)\_1253.92lm@250mA\_P=8.86265W\_I=249.8mA

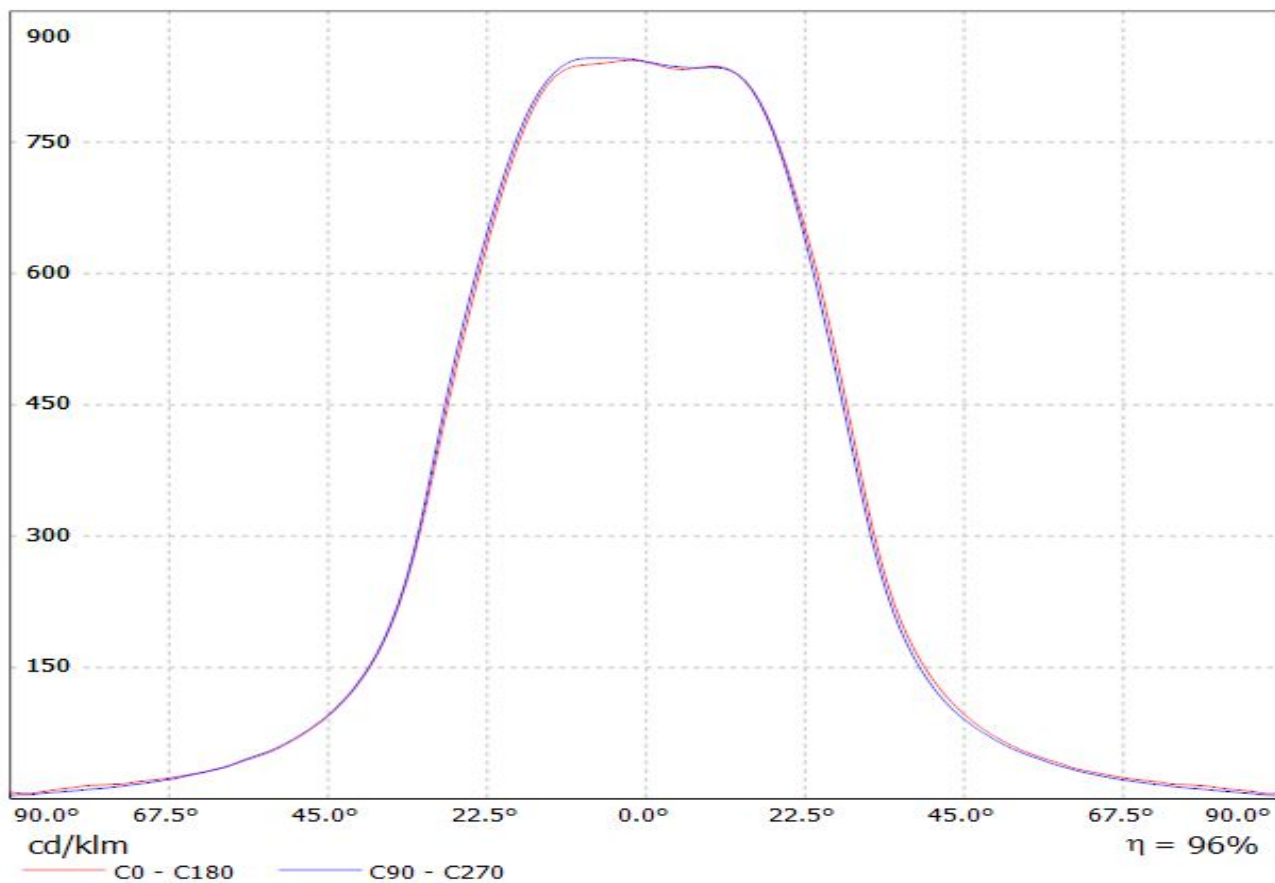



Luminaire: LEDiL Oy CS14130\_HB-IP-2X6-W\_(XP-G2) Eff.93.2%  
Lamps: 1 x CREE\_XP-G2\_1303lm@250mA\_P=8.58363W\_I=249.8mA

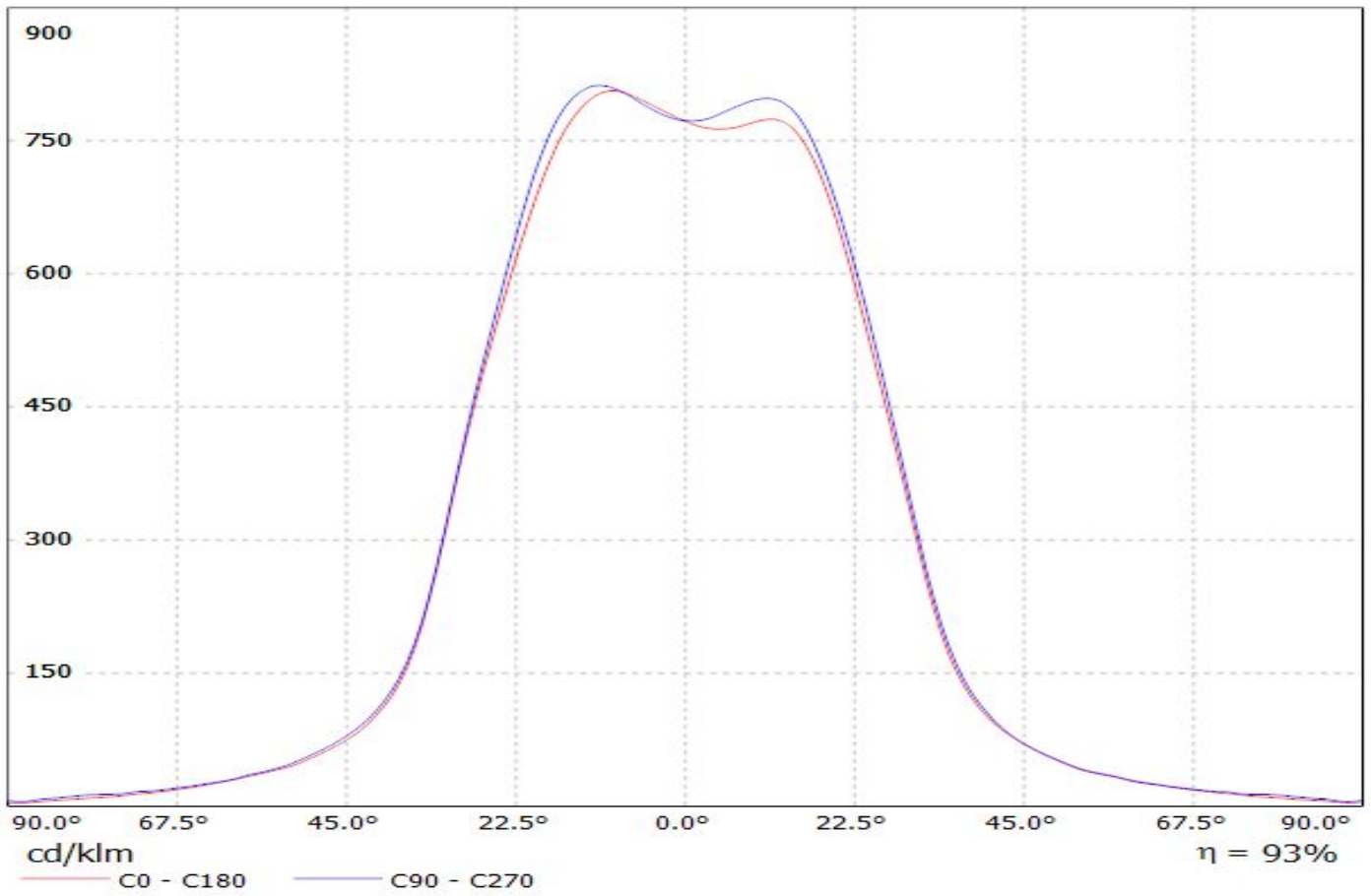

Luminaire: LEDiL Oy CS14130\_HB-IP-2X6-W\_(LUXEON-R) Eff 94.0%  
Lamps: 1 x Luxeon\_R\_6x2\_1154lm@250mA\_P=8.29161W\_I=249.8mA

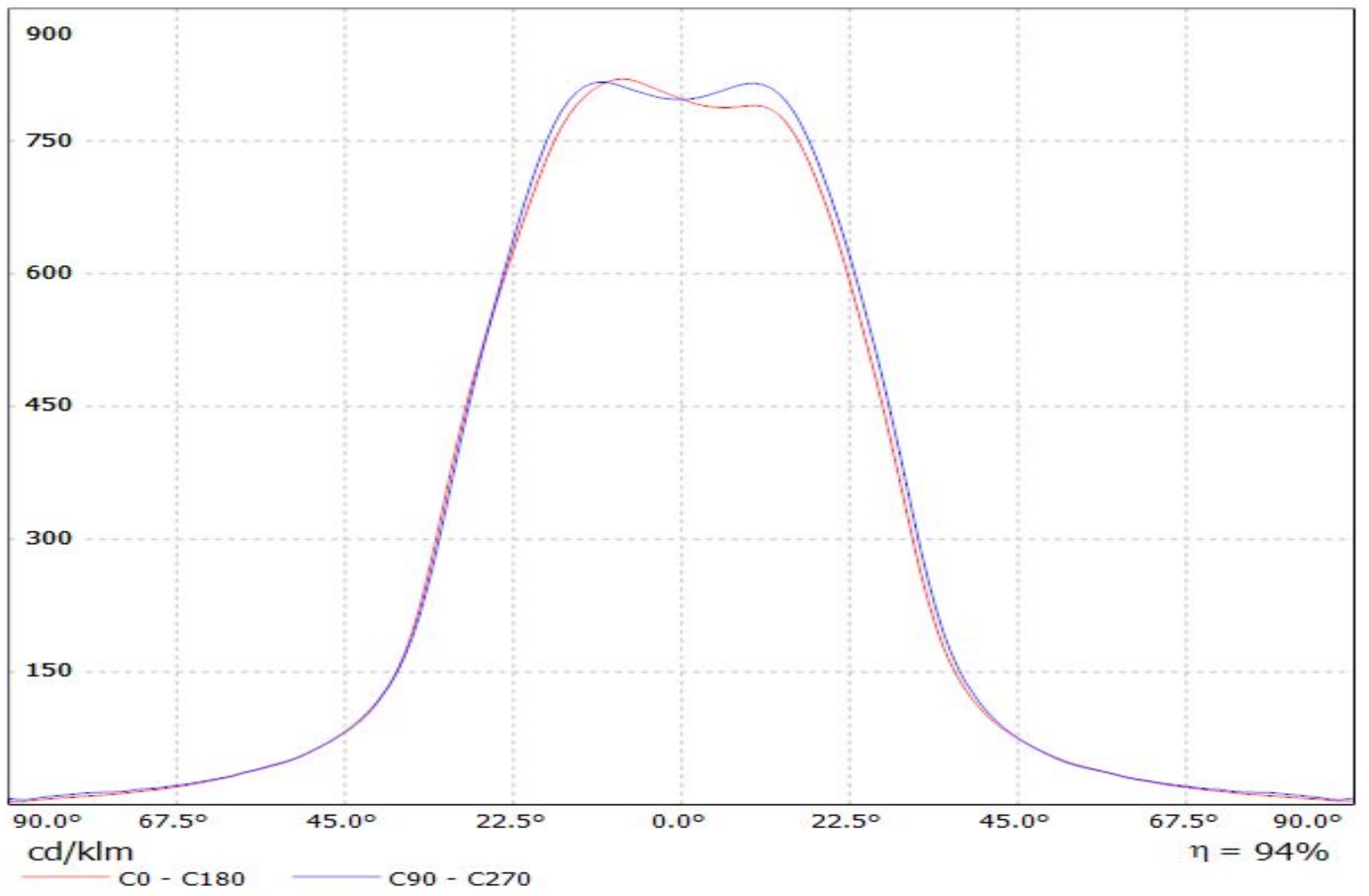

Luminaire: LEDiL Oy CS14130\_HB-IP-2X6-W\_(Z5M1) Eff.94.0%

Lamps: 1 x SEOUL\_Z5M1\_2x6\_(SZ5-M1-WW-C8)\_1177.2lm@250mA\_P=8.5619W\_I=249.8mA

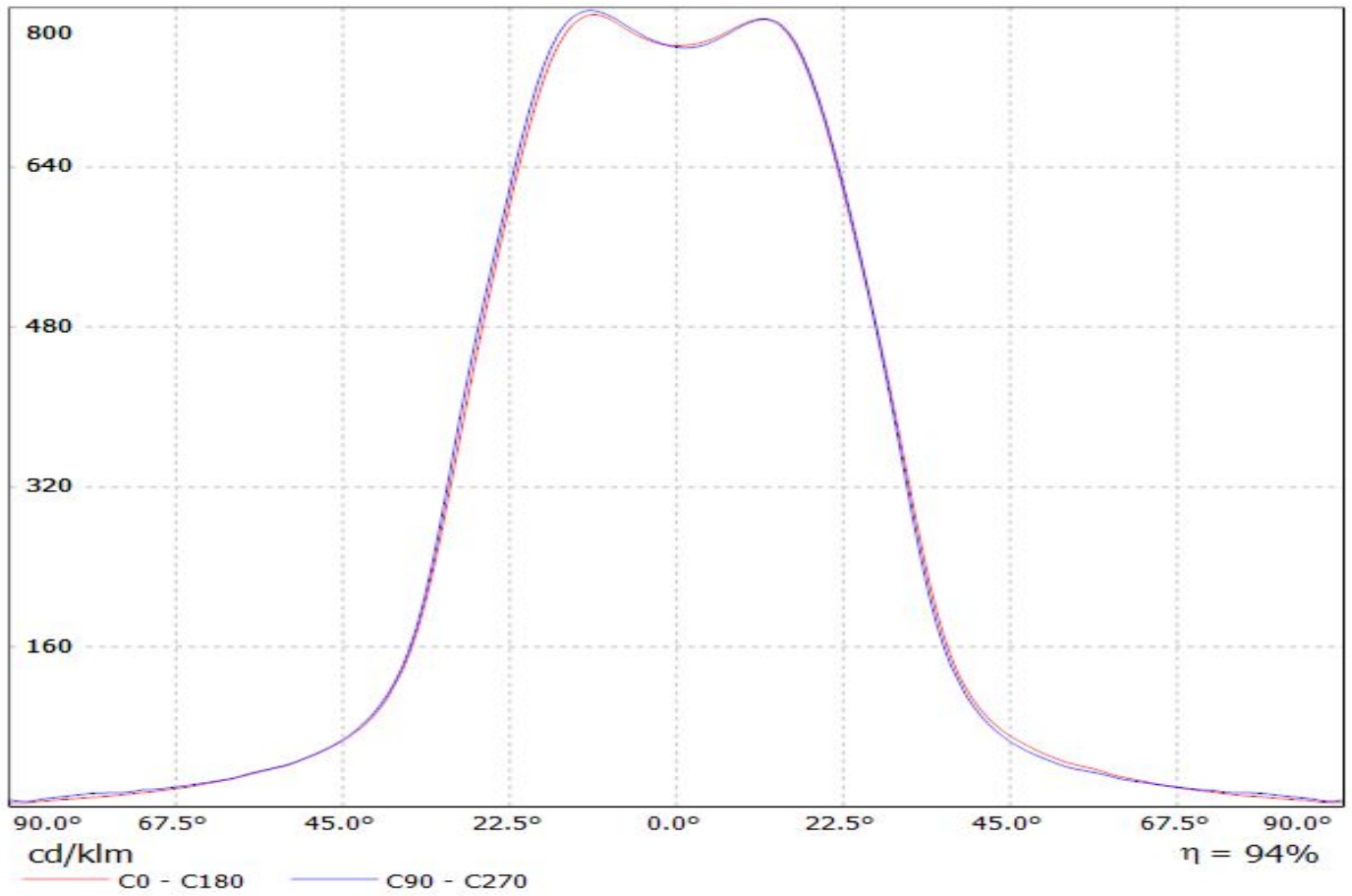

Luminaire: LEDiL Oy CS14130\_HB-IP-2X6-W\_(XP-G) Eff 94.0%  
Lamps: 1 x CREE\_XP-G\_6x2\_799.2lm@250mA\_P=8.52542W\_I=249.8mA

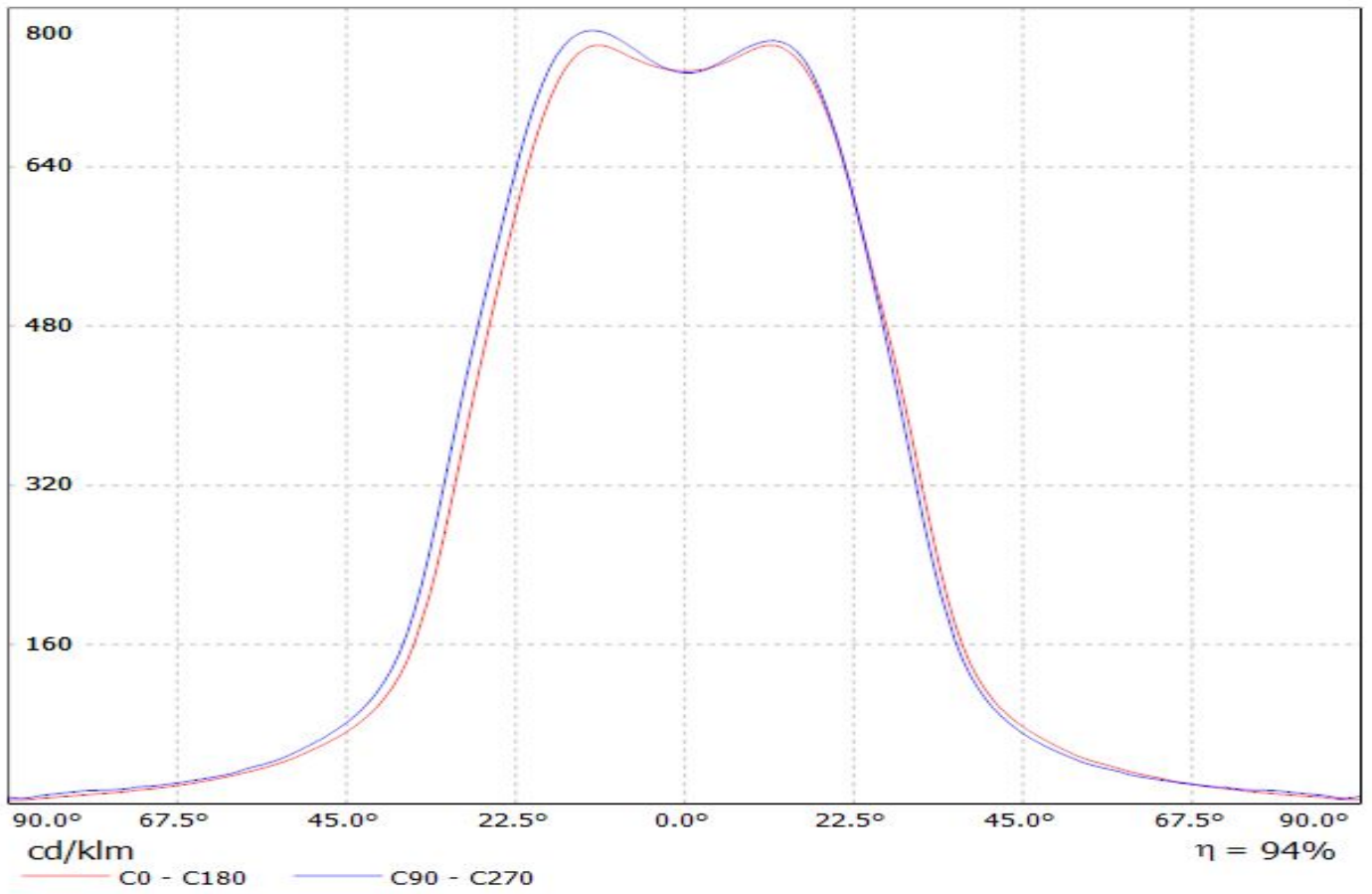

Luminaire: LEDiL Oy CS14130\_HB-IP-2X6-W\_(LUXEON\_T) Eff.94.0%  
Lamps: 1 x LUXEON\_T\_6x2\_(LXH8-FW30)\_1062.6lm@250mA\_P=8.46572W\_I=249.8mA

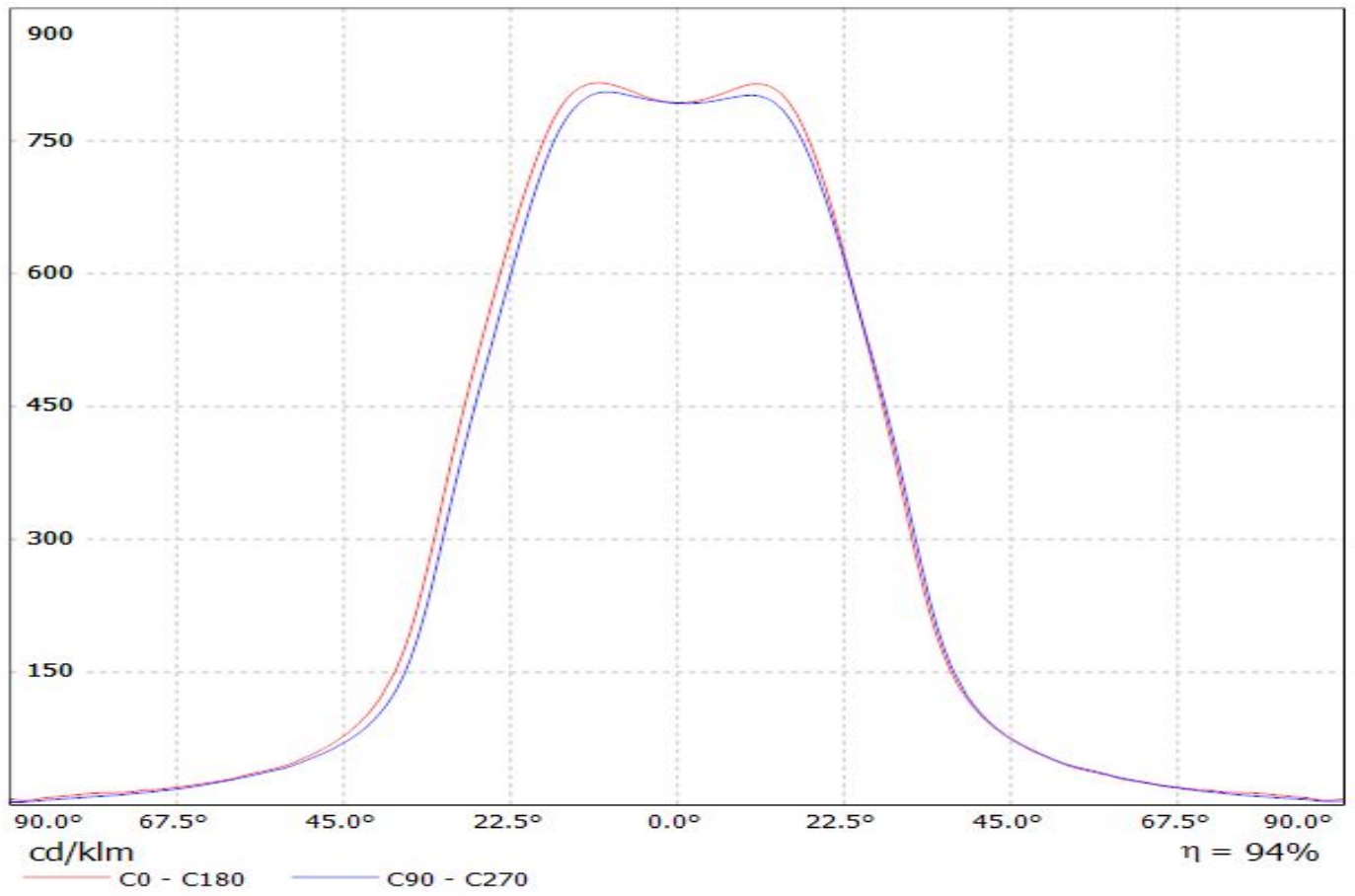

Luminaire: LEDiL Oy CS14130\_HB-IP-2X6-W\_(XM-L2) Eff.94.0%  
Lamps: 1 x CREE\_XM-L2\_2x6\_1197.78lm@250mA\_P=8.38555W\_I=254.1mA

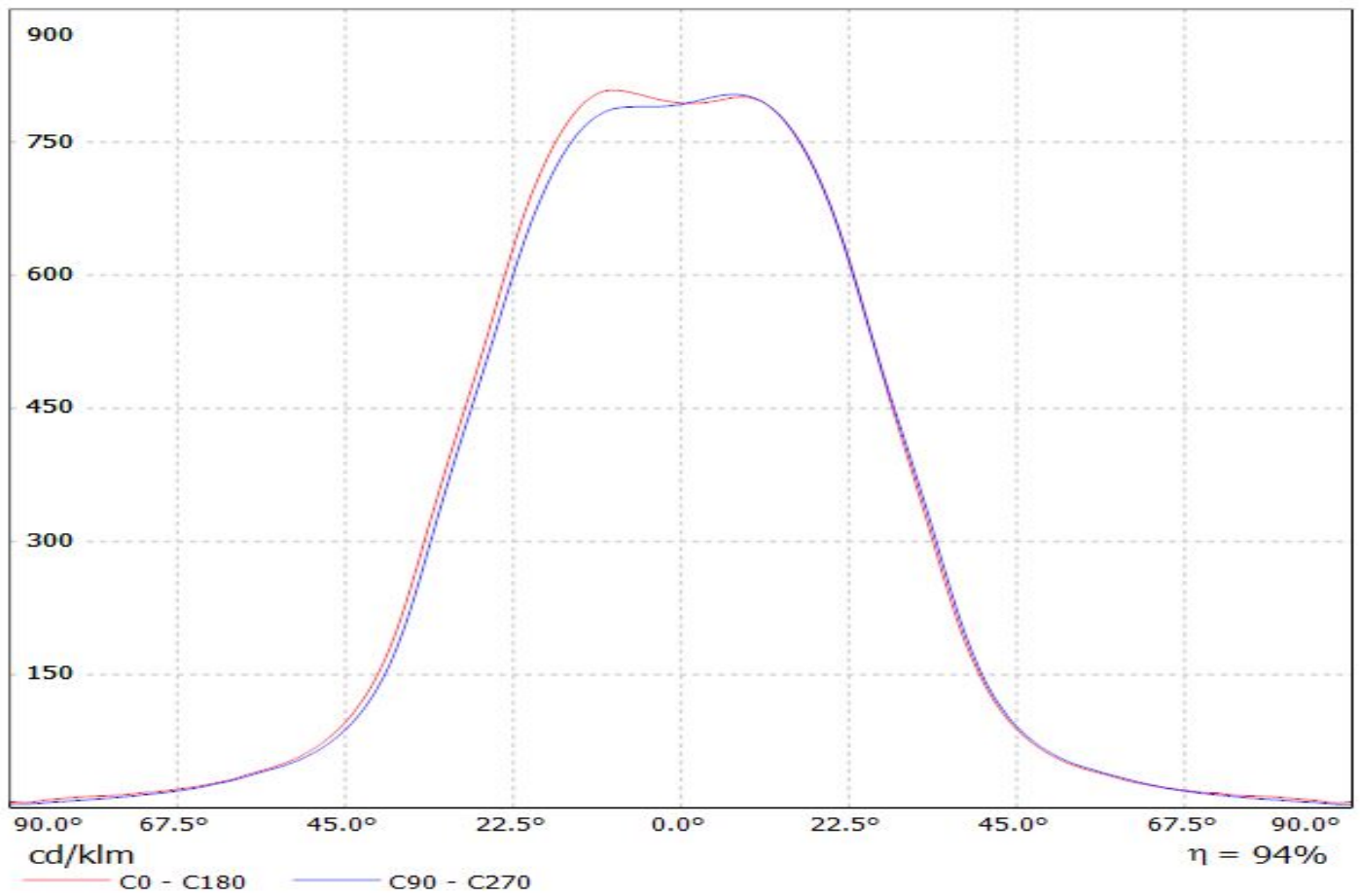

Luminaire: LEDiL Oy CS14130\_HB-IP-2X6-W\_(XP-L)

Lamps: 1 x CREE\_XP-L\_2x6\_(XPLAWT-0-7A3-U50-0H-0001)\_1253.88lm@250mA\_P=8.22317W\_I=249.8mA

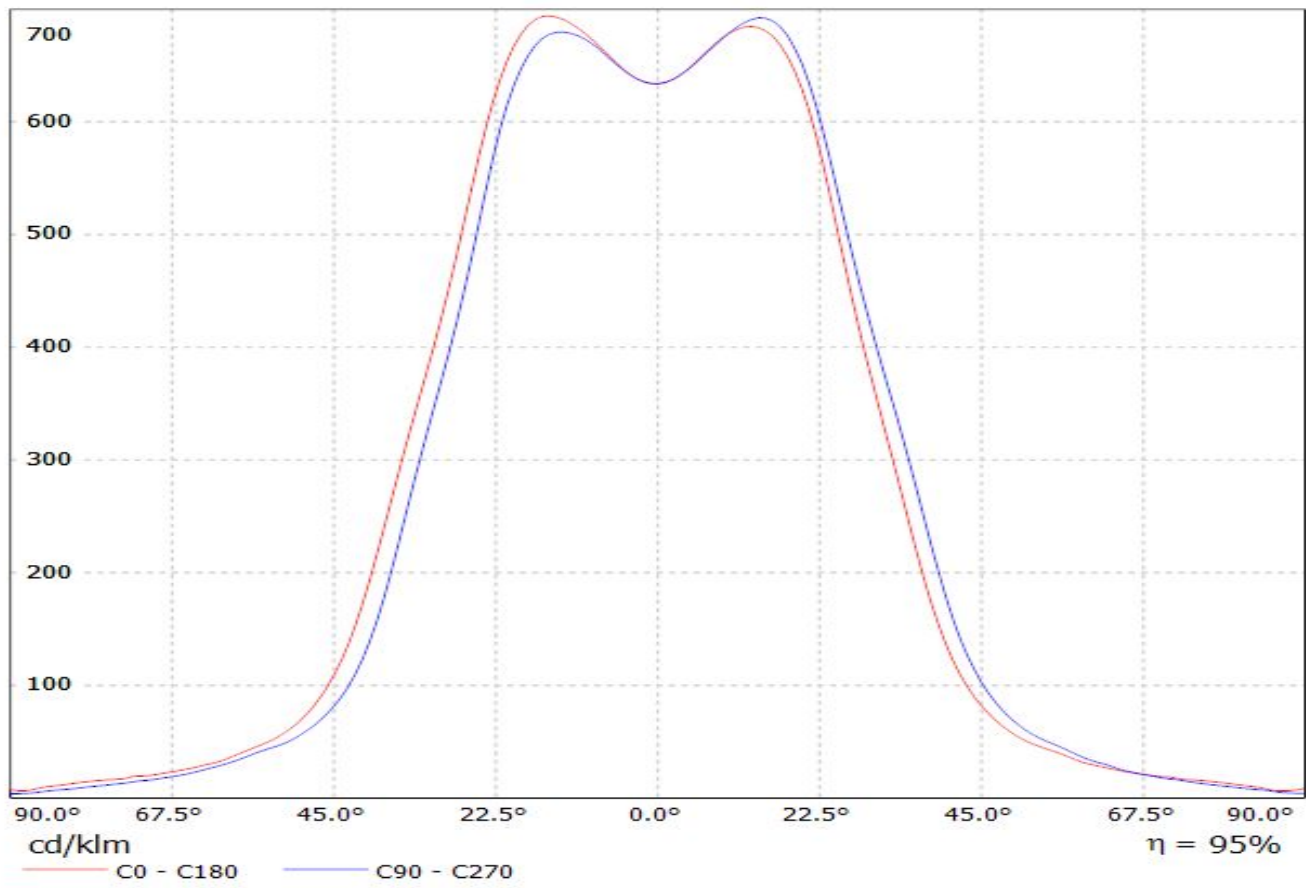

Luminaire: Ledil Oy CS14130\_HB-IP-2X6-W-DURIS-S8\_SIMULATED  
Lamps: 1 x DURIS-S8

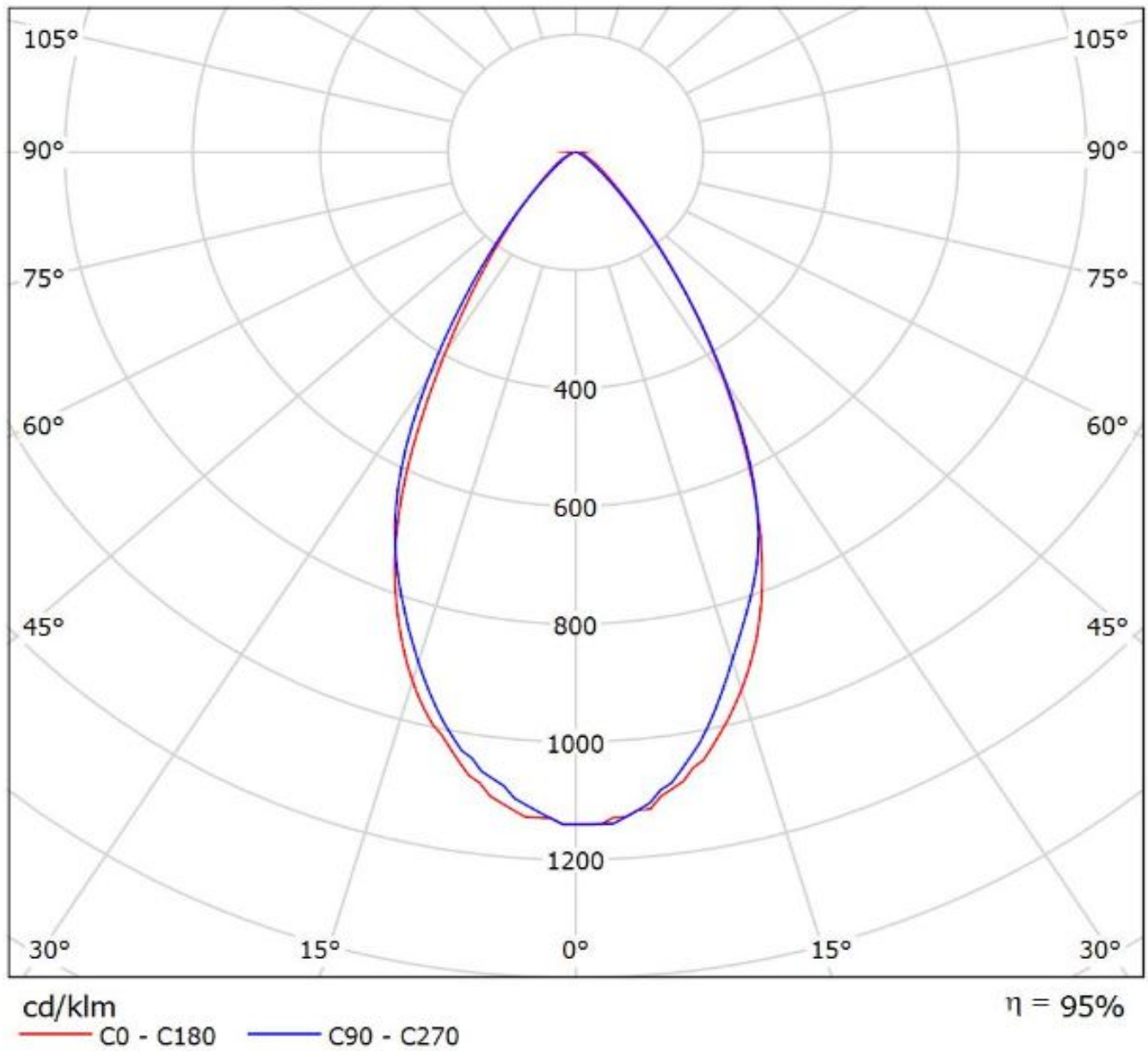



Luminaire: LEDiL Oy CS14130\_HB-IP-2X6-W\_(LUXEON\_Z\_ES) Eff.94.0%  
Lamps: 1 x LUXEON\_Z\_ES\_990.2lm@250mA\_P=8.31159W\_I=249.8mA

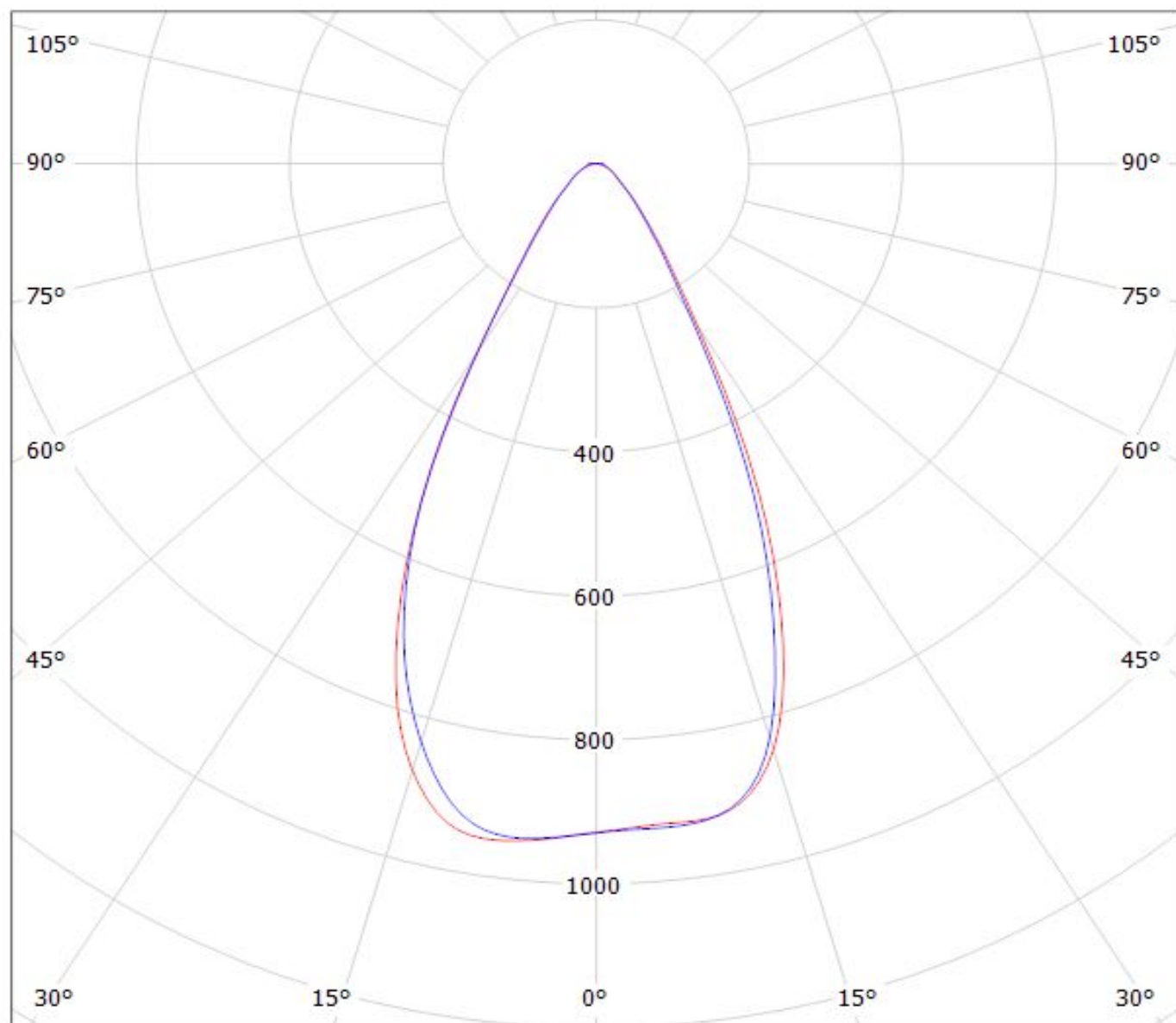

cd/klm

— C0 - C180    — C90 - C270

$\eta = 94\%$

Luminaire: LEDiL Oy CS14130\_HB-IP-2X6-W\_(Luxeon\_TX)  
Lamps: 1 x Luxeon\_TX\_2x6\_1301.4lm@250mA\_P=8.26138W\_I=249.8mA

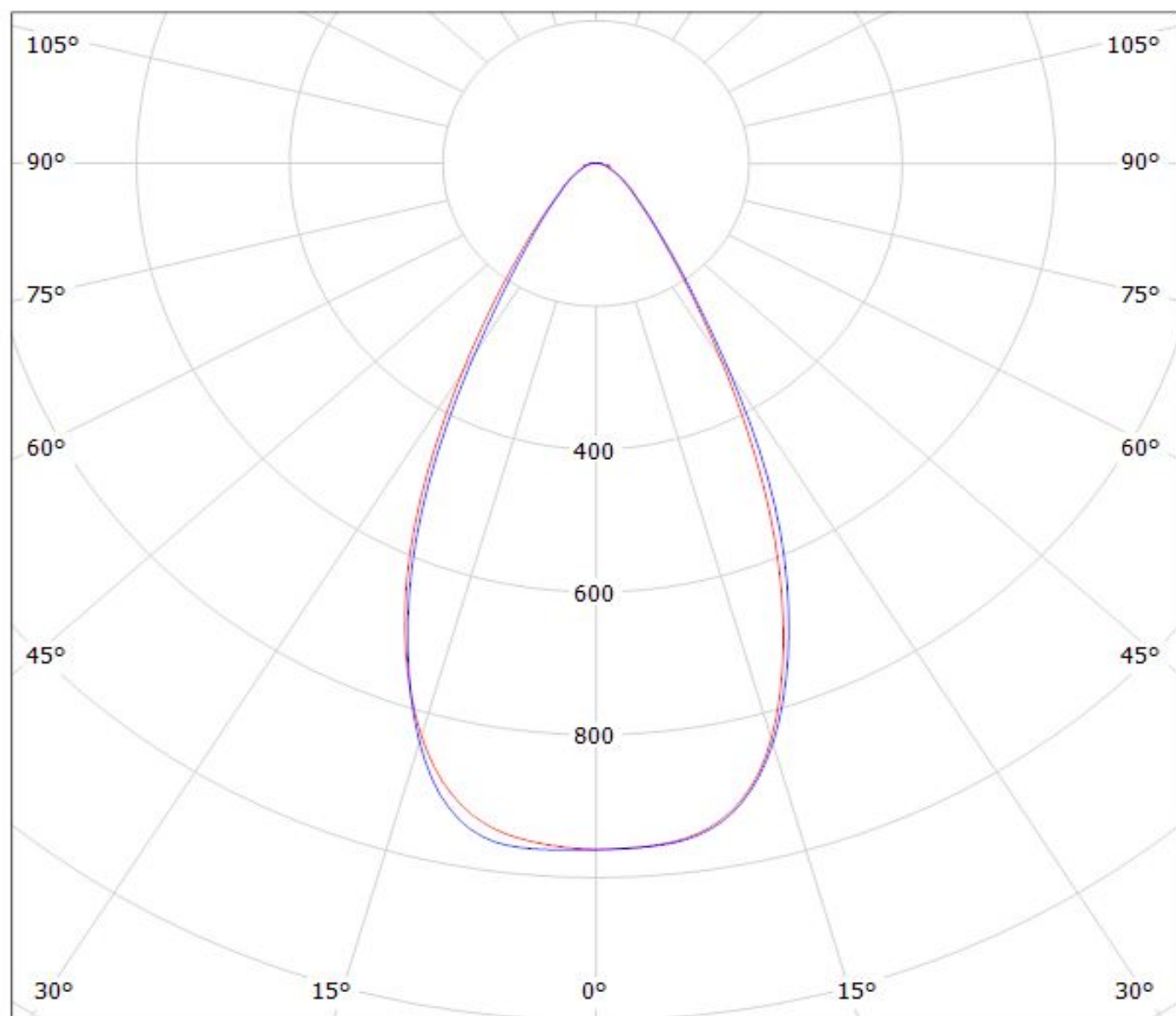

cd/klm

— C0 - C180

— C90 - C270

$\eta = 94\%$

# Ledil CS14130\_HB-IP-2X6-W\_(TL1L4) / LDC (Polar)

Luminaire: Ledil CS14130\_HB-IP-2X6-W\_(TL1L4)

Lamps: 1 x Toshiba\_TL1L4\_2x6\_(TL1L4-DW0)\_1263.19lm@250mA\_CCT=6500K\_P=8.5W\_I=0.25A

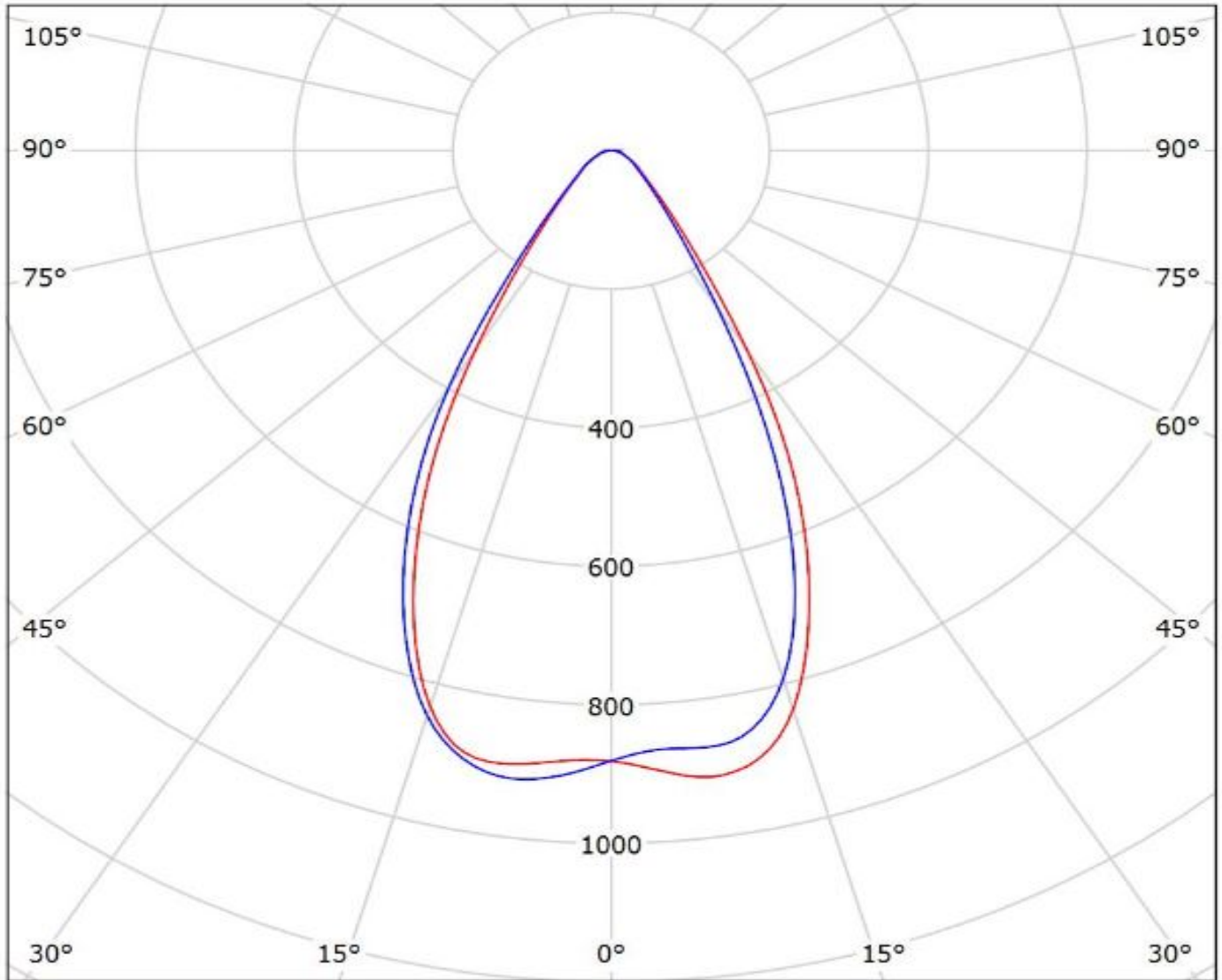

cd/klm

— C0 - C180

— C90 - C270

η = 95%

Luminaire: LEDiL Oy CS14130\_HB-IP-2X6-W\_(REBEL-ES) Eff.94.0%  
Lamps: 1 x Luxeon\_Rebel-ES\_2x6\_864.2lm@250mA\_P=9.03127W\_I=249.8mA

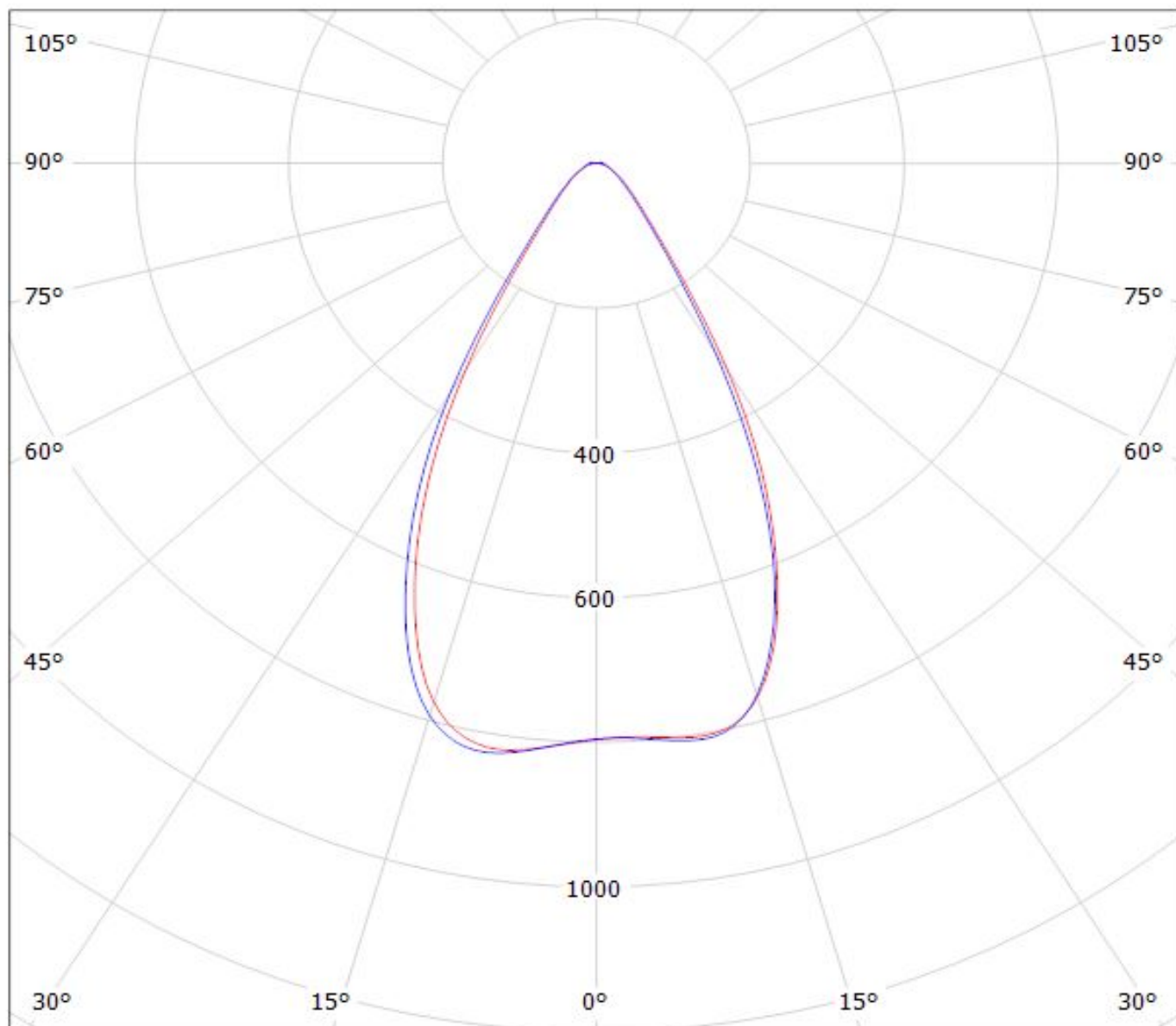

cd/klm

— C0 - C180    — C90 - C270

$\eta = 94\%$

Luminaire: LEDiL Oy CS14130\_HB-IP-2X6-W\_(XT-E)

Lamps: 1 x CREE\_XT-E\_6x2\_(XTEAWT-00-0000-000000HE4)\_1253.92lm@250mA\_P=8.86265W\_I=249.8mA

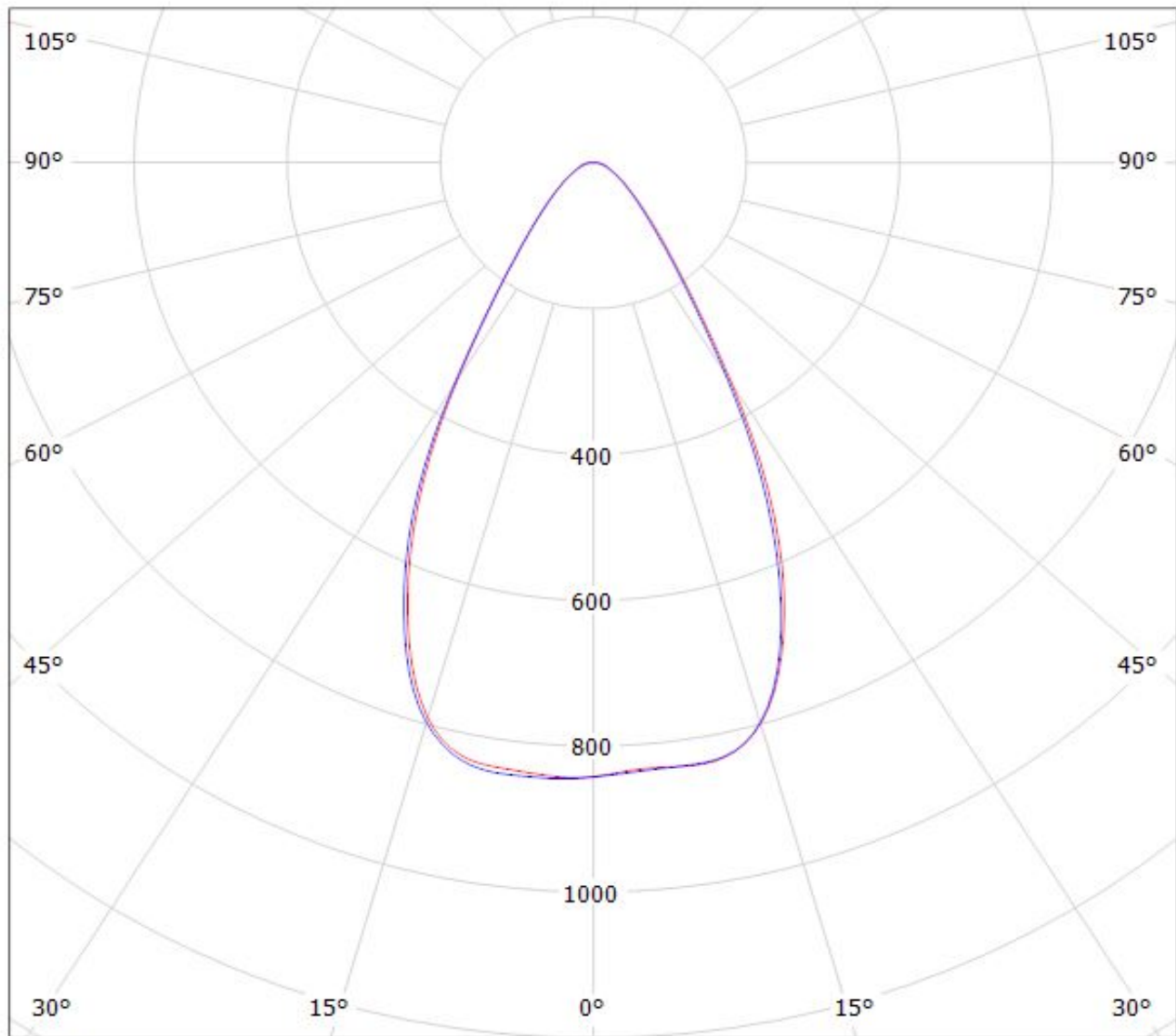

cd/klm

$\eta = 96\%$

— C0 - C180

— C90 - C270

Luminaire: LEDiL Oy CS14130\_HB-IP-2X6-W\_(XP-G2) Eff.93.2%  
Lamps: 1 x CREE\_XP-G2\_1303lm@250mA\_P=8.58363W\_I=249.8mA

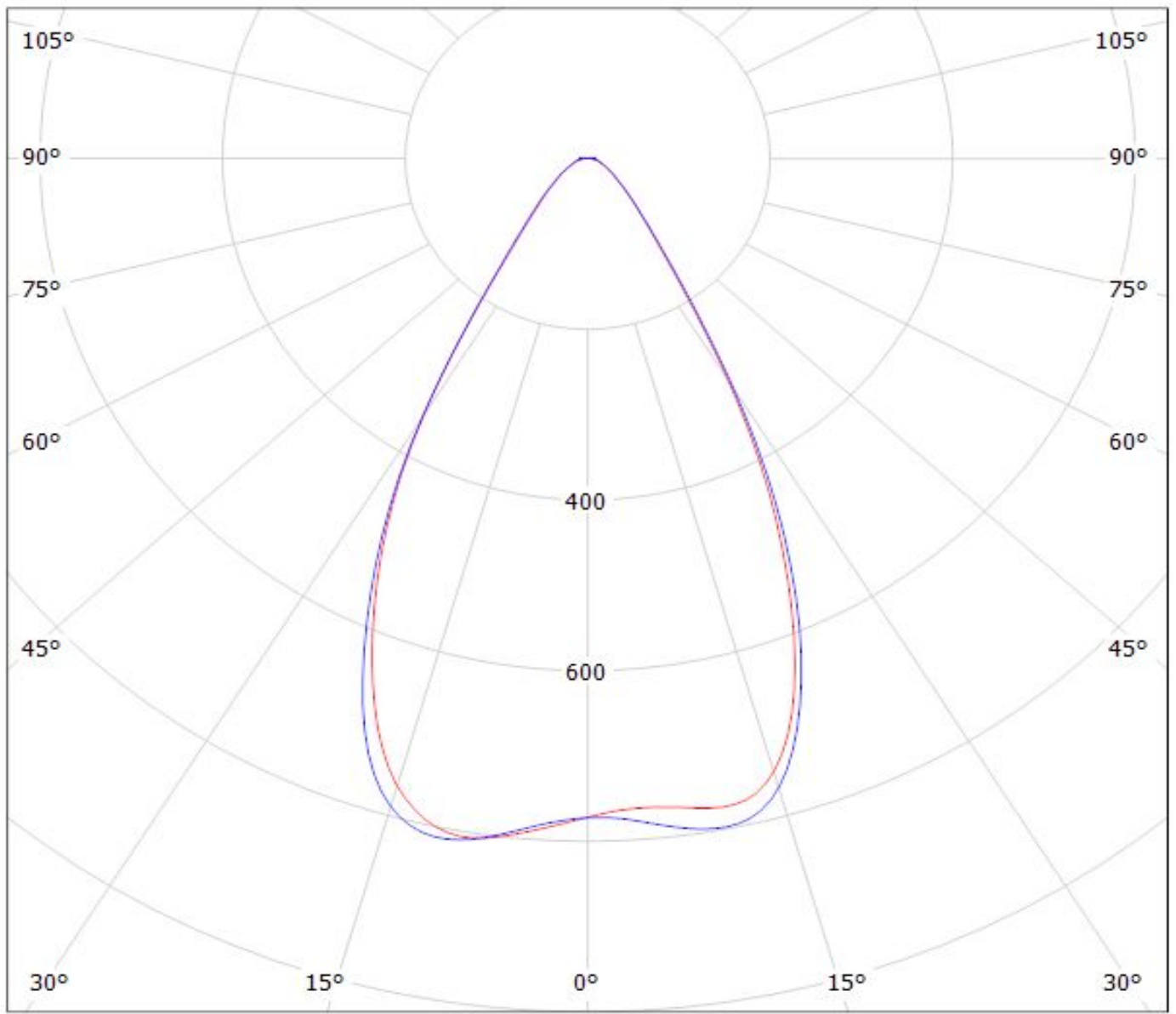

cd/klm  
— C0 - C180    — C90 - C270

$\eta = 93\%$

Luminaire: LEDiL Oy CS14130\_HB-IP-2X6-W\_(LUXEON-R) Eff.94.0%  
Lamps: 1 x Luxeon\_R\_6x2\_1154lm@250mA\_P=8.29161W\_I=249.8mA

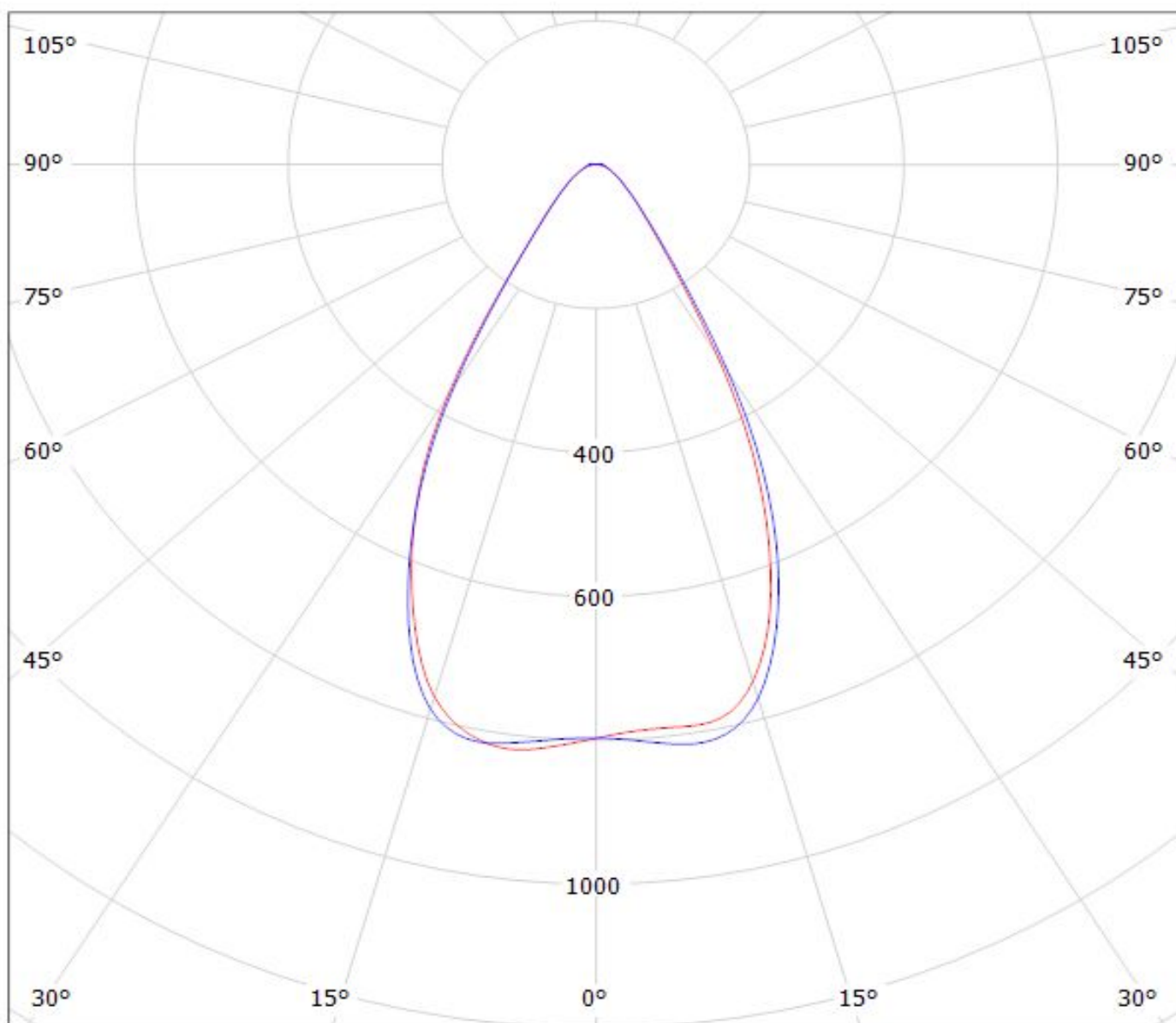

cd/klm

— C0 - C180

— C90 - C270

$\eta = 94\%$

Luminaire: LEDiL Oy CS14130\_HB-IP-2X6-W\_(Z5M1) Eff.94.0%

Lamps: 1 x SEOUL\_Z5M1\_2x6\_(SZ5-M1-WW-C8)\_1177.2lm@250mA\_P=8.5619W\_I=249.8mA

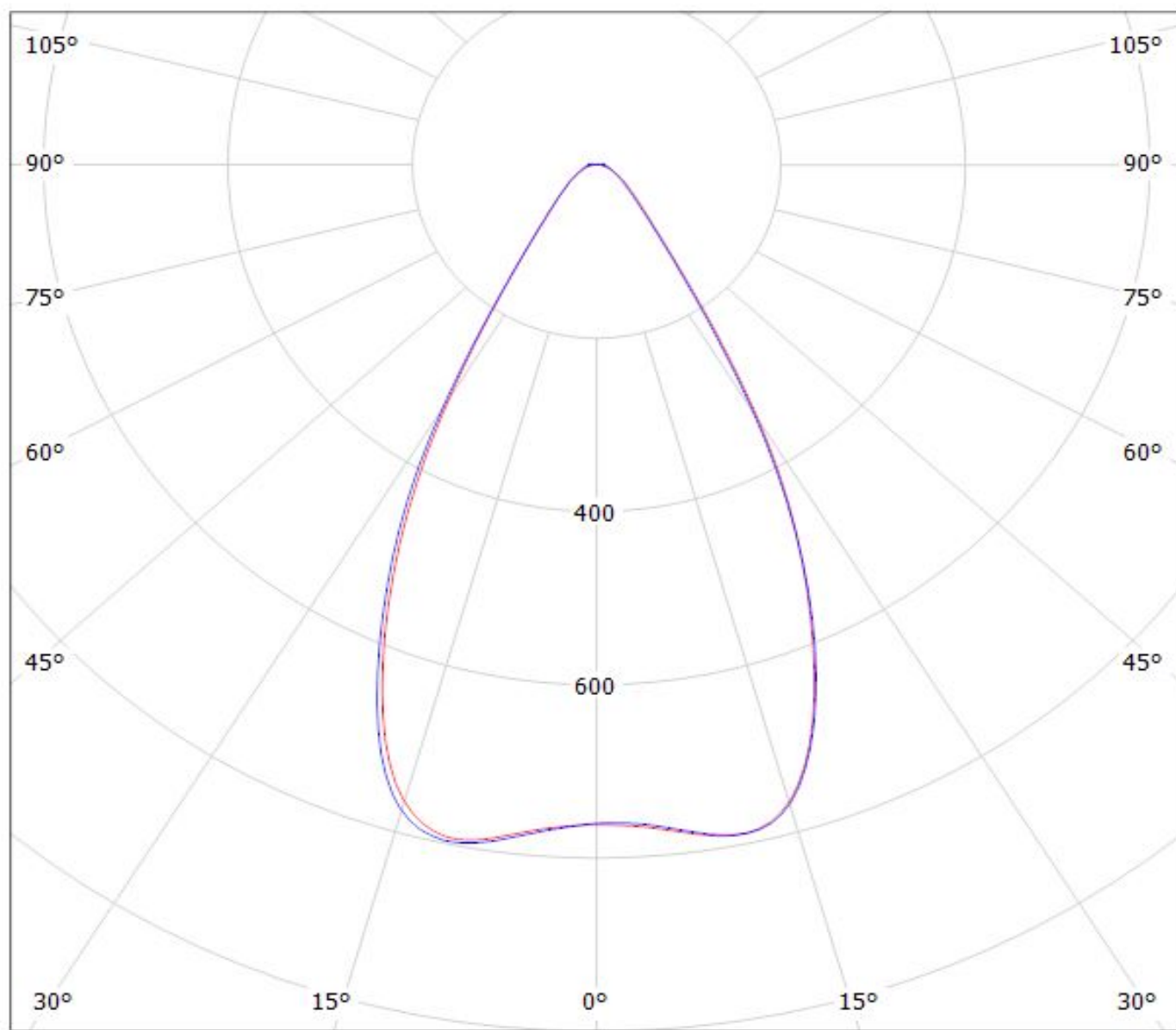

cd/klm

— C0 - C180

— C90 - C270

$\eta = 94\%$



Luminaire: LEDiL Oy CS14130\_HB-IP-2X6-W\_(XP-G) Eff.94.0%  
Lamps: 1 x CREE\_XP-G\_6x2\_799.2lm@250mA\_P=8.52542W\_I=249.8mA

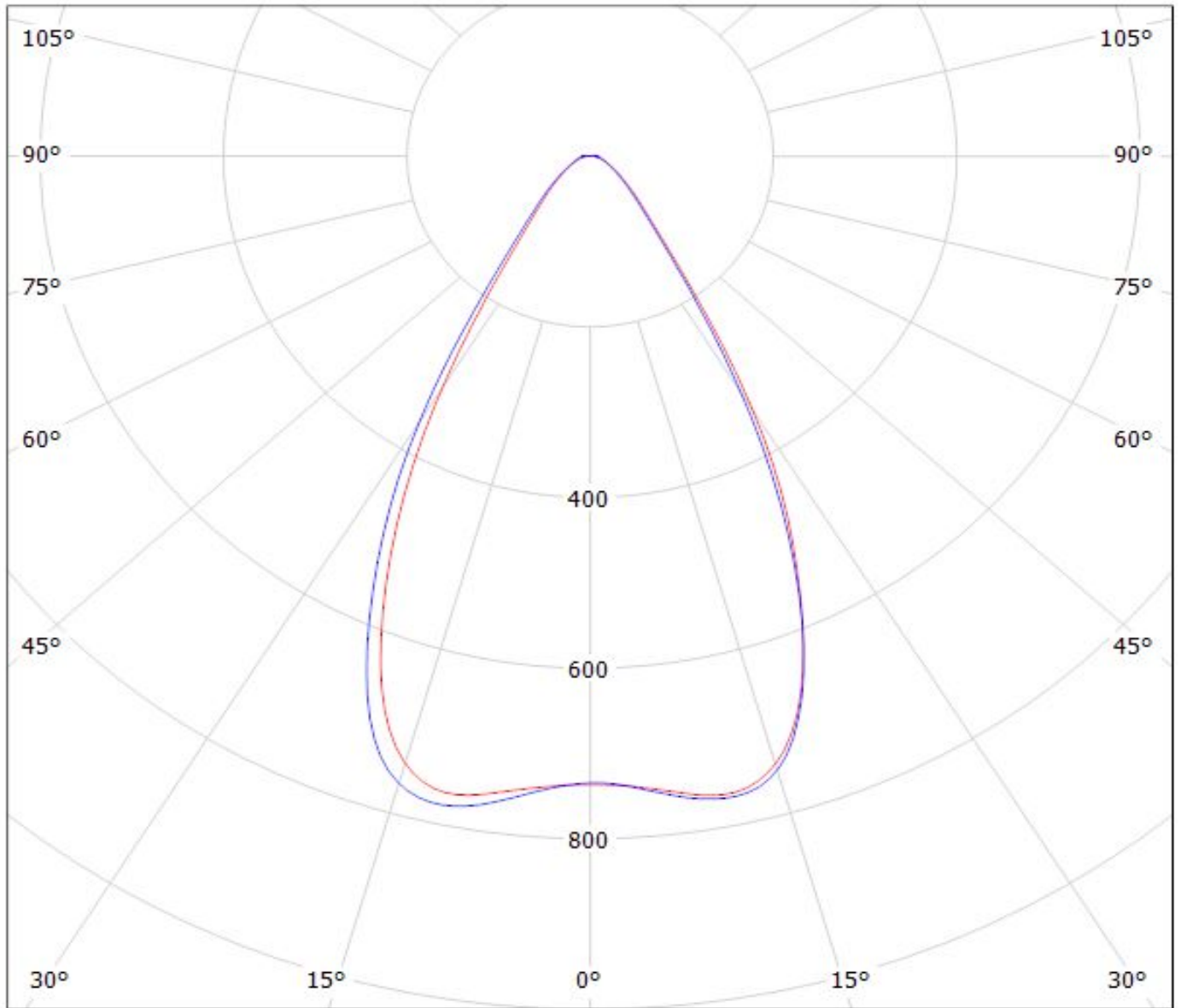

cd/klm  
— C0 - C180    — C90 - C270

$\eta = 94\%$

Luminaire: LEDiL Oy CS14130\_HB-IP-2X6-W\_(LUXEON\_T) Eff.94.0%

Lamps: 1 x LUXEON\_T\_6x2\_(LXH8-FW30)\_1062.6lm@250mA\_P=8.46572W\_I=249.8mA

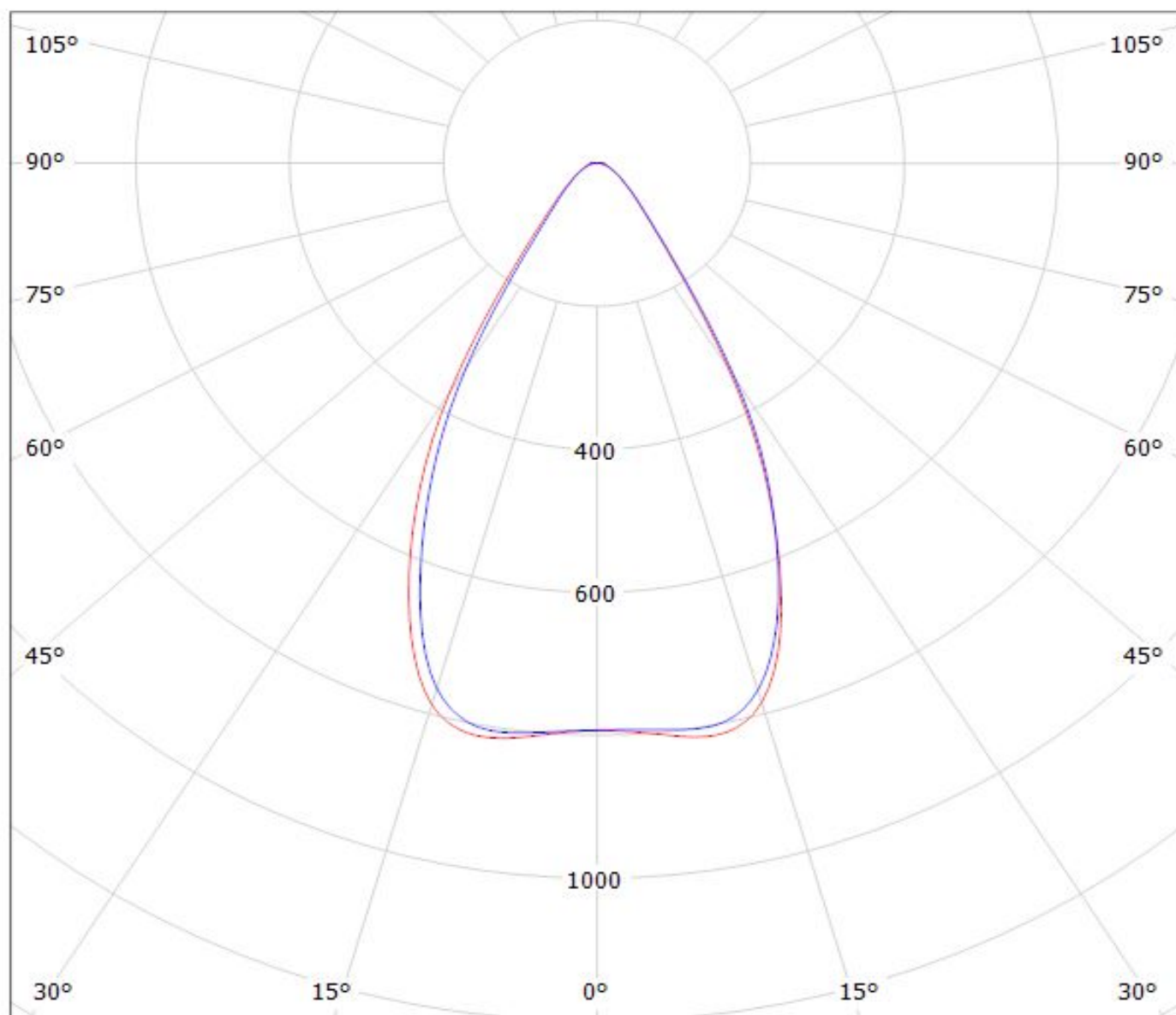

cd/klm

— C0 - C180

— C90 - C270

$\eta = 94\%$

Luminaire: LEDiL Oy CS14130\_HB-IP-2X6-W\_(XM-L2) Eff.94.0%  
Lamps: 1 x CREE\_XM-L2\_2x6\_1197.78lm@250mA\_P=8.38555W\_I=254.1mA

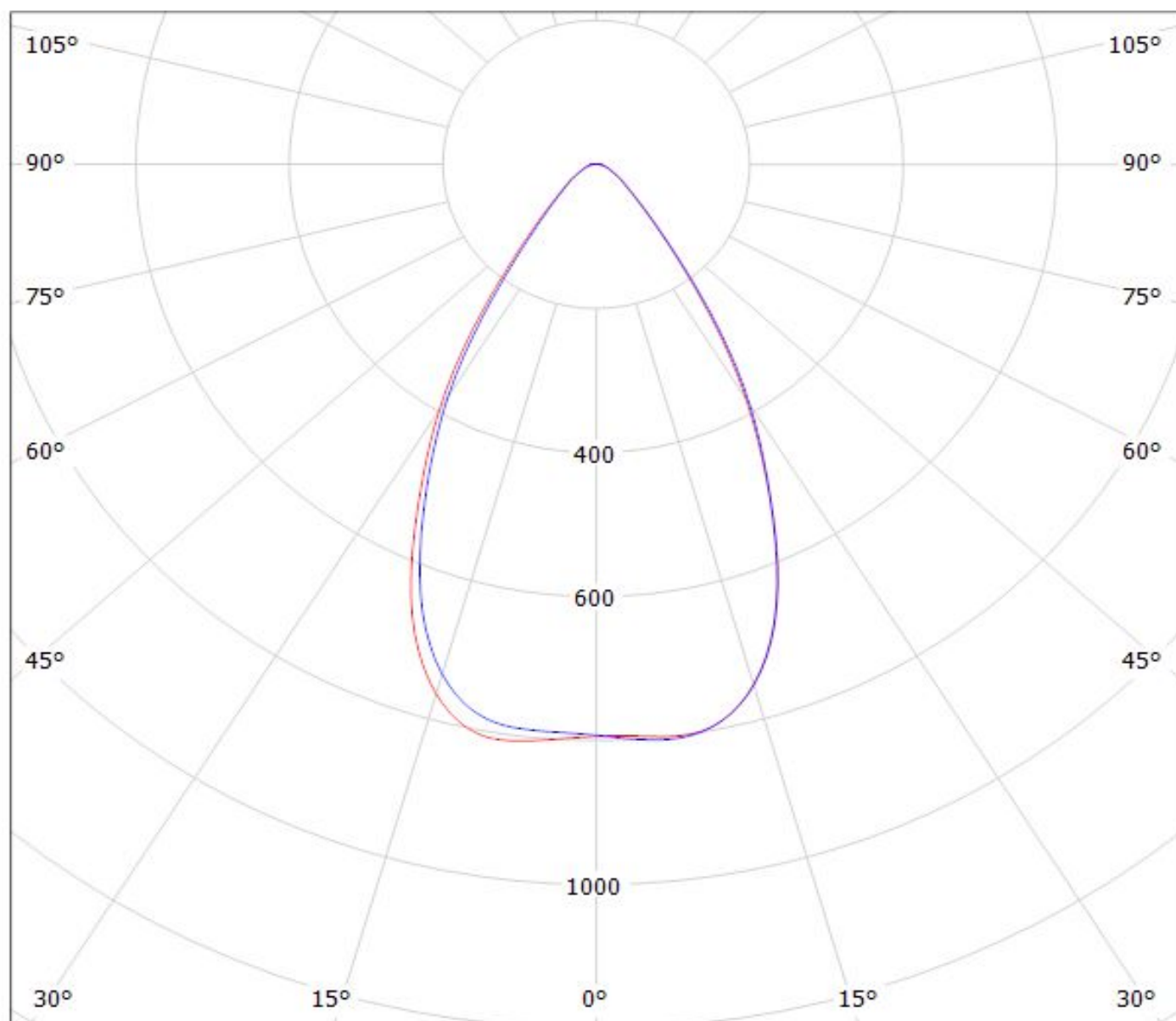

cd/klm

— C0 - C180    — C90 - C270

$\eta = 94\%$

Luminaire: LEDiL Oy CS14130\_HB-IP-2X6-W\_(XP-L)

Lamps: 1 x CREE\_XP-L\_2x6\_(XPLAWT-0-7A3-U50-0H-0001)\_1253.88lm@250mA\_P=8.22317W\_I=249.8mA

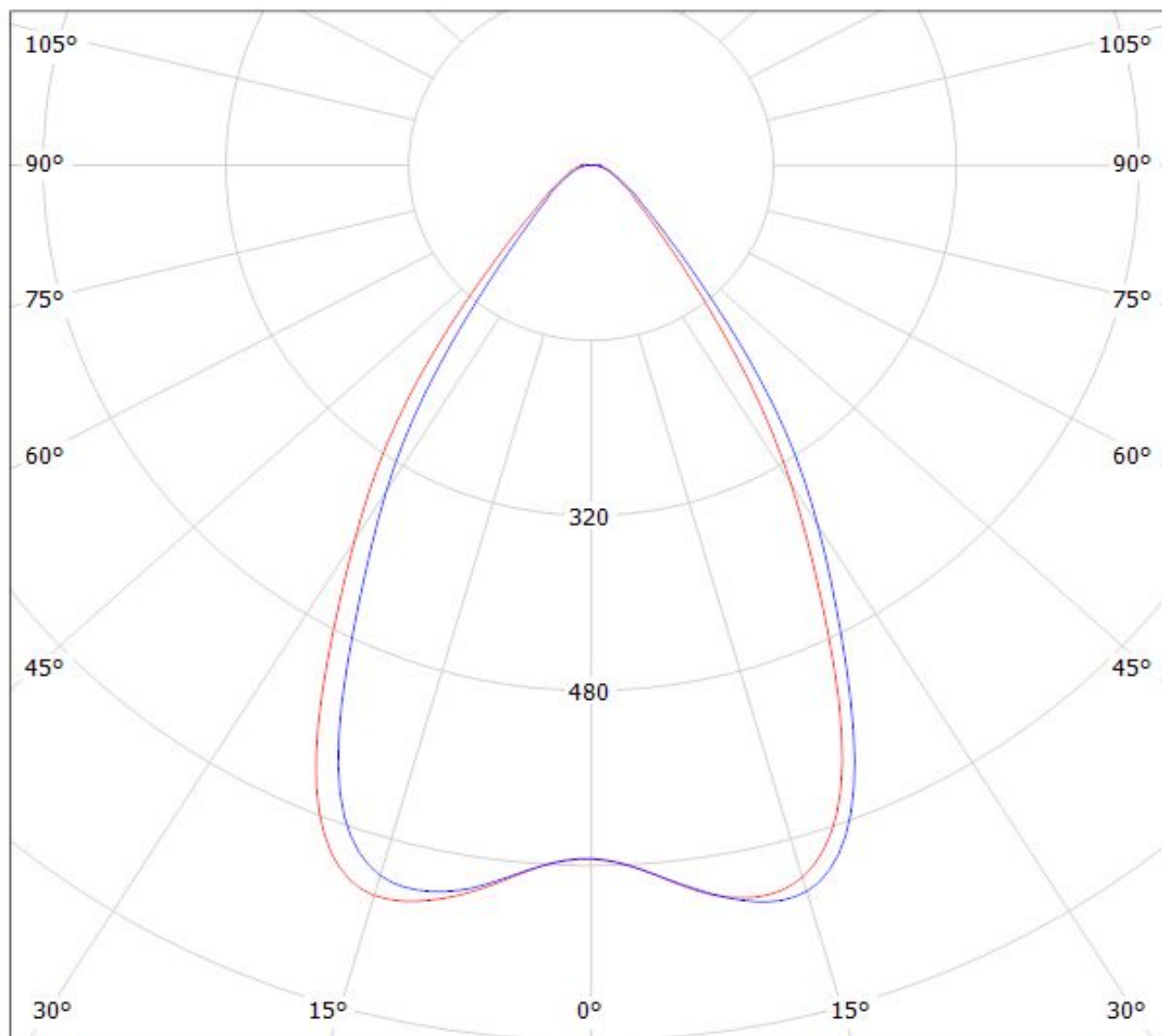

cd/klm

$\eta = 95\%$

— C0 - C180

— C90 - C270

**NOTE: The typical divergence will be changed by different color, chip size and chip position tolerance. The typical total divergence is the full angle measured where the luminous intensity is half of the peak value.**