

**PROPER USE GUIDELINES**

Cumulative Trauma Disorders can result from the prolonged use of manually powered hand tools. Hand tools are intended for occasional use and low volume applications. A wide selection of powered application equipment for extended-use, production operations is available.

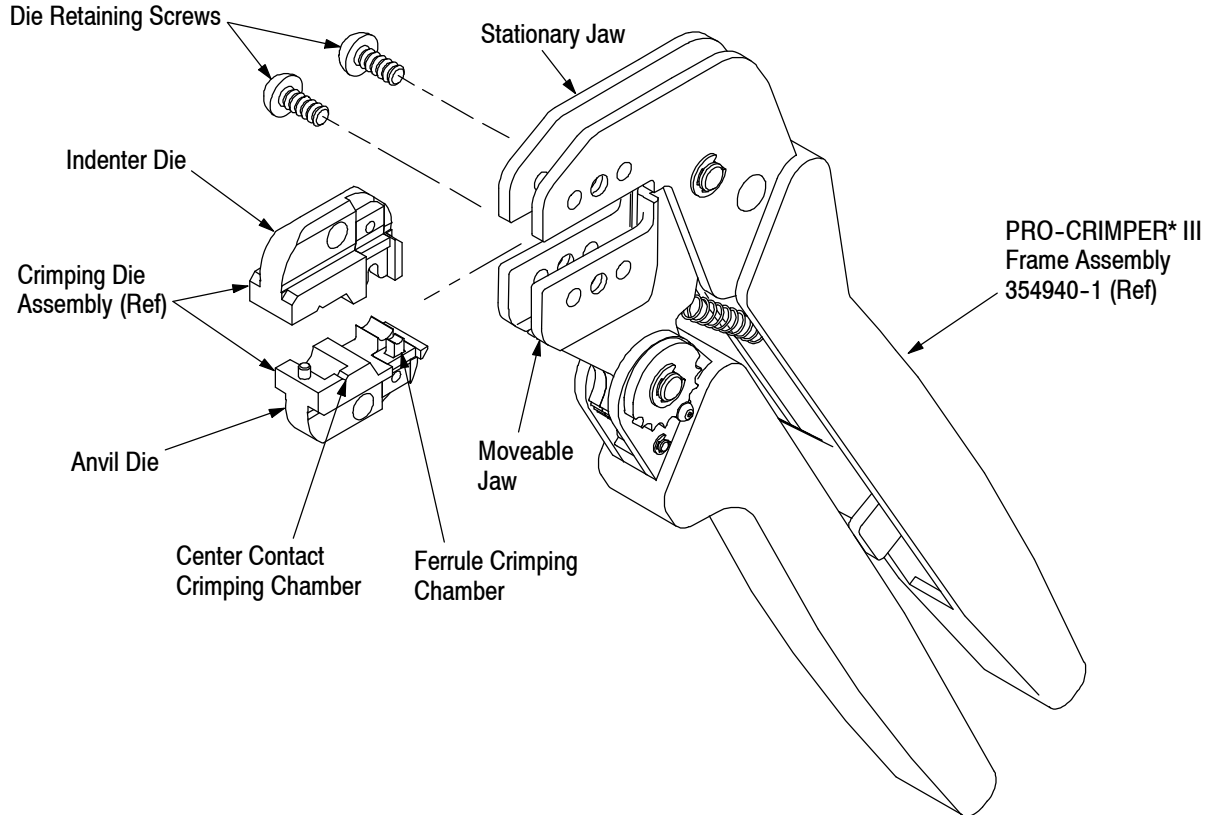

DIE ASSEMBLY PART NUMBER	CONNECTOR BASE PART NUMBER
220189-1, 220189-2	227000, 227079, 228980, 228979
220189-3	225395, 225396, 225397, 225398
58330-1	227079

Figure 1

**1. INTRODUCTION**

This instruction sheet covers the use and maintenance of Crimping Die Assemblies listed in Figure 1. The dies are used in PRO-CRIMPER III Frame Assembly 354940-1 to crimp 50- and 75-Ohm BNC, and 50-Ohm TNC Dual-Crimp Connectors onto various size cable. Refer to Figure 1 for a list of connectors that are compatible with the die assemblies. Refer to Catalog 82074 for additional product part number information. For part numbers not listed, contact TE Connectivity Product Engineering for recommendations.

Reasons for reissue are provided in Section 8, REVISION SUMMARY.

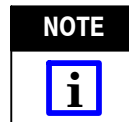

*All dimensions in this document are in millimeters [with inches in brackets]. Figures and Illustrations are for reference only and are not drawn to scale.*

**2. DESCRIPTION**

Each die assembly consists of an indenter die and an anvil die, which when mated form two crimping chambers. The large crimping chamber crimps the connector ferrule and the small crimping chamber crimps the connector center contact. Each die is held in the tool by a single screw. See Figure 1.

### 3. DIE INSTALLATION

To be sure that the die assembly is properly aligned during installation, proceed as follows:

1. Slide the die assembly into the partially-opened tool jaws. The anvil die must be installed in the movable jaw of the tool and the indenter in the stationary jaw. The center contact crimping chamber *must* be toward the front of the tool as shown in Figure 1.
2. Insert, but do not completely tighten, the die retaining screws.
3. Close the tool jaws and carefully align the dies so that the anvil die enters the indenter die. Once the anvil has entered the indenter, place a copper bus bar ( $1.57 \pm 0.05$  mm [ $.062 \pm .002$  in.] diameter) into the center contact crimping chamber of the die assembly.
4. With bus bar in place, close the tool jaws completely. Hold the tool handles together and tighten the die retaining screws with the appropriate screwdriver.

### 4. CRIMPING PROCEDURE

**NOTE** For detailed information on cable selection, cable strip lengths, and proper assembly of the connector, refer to the instructions provided with the connector.

Select the appropriate die assembly that is compatible with the connector being used. Proceed as follows:

#### 4.1. Center Contact (Figure 2)

1. Slide the ferrule onto the cable, then strip the cable to the proper dimensions.
2. Slide center contact onto center conductor of cable; then insert contact assembly into the center contact crimping chamber of the anvil die. See Figure 2.

**NOTE** Make sure that the flange on the end of the center contact butts against the edge of the die. Refer to the cross-sectional view in Figure 2.

3. Crimp the center contact by holding the cable in place; then close the tool handles until the ratchet releases.
4. Remove the crimped center contact assembly from the crimping dies.

*Crimping the Center Contact*

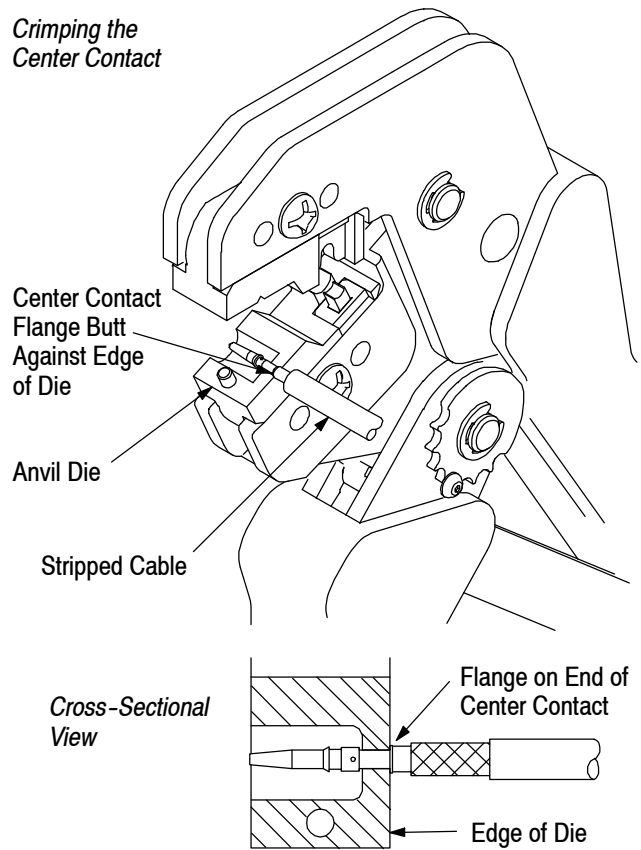

Figure 2

#### 4.2. Ferrule (Figure 3)

1. Insert the crimped center contact into the connector body until the cable dielectric butts against the dielectric inside the connector body. The flared braid must fit around the support sleeve of the connector body.

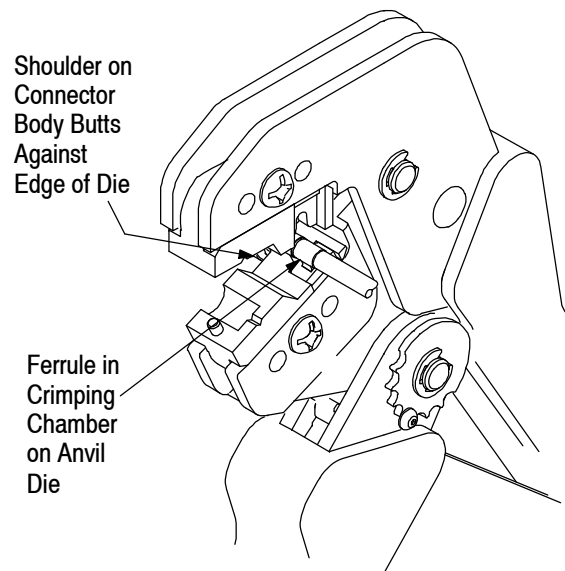

Figure 3

2. Slide the ferrule forward over the braid until the ferrule butts against the shoulder on the connector body.
3. Place the ferrule in the ferrule crimping chamber of the anvil die so that the shoulder on the connector body butts against the edge of the die. See Figure 3.
4. Holding the assembly in place, close the tool handles until the ratchet releases.
5. Remove crimped assembly from the crimping dies.

## 5. CRIMP HEIGHT ADJUSTMENT (Figure 4)

The tool frame assembly ratchet mechanism features an adjustment wheel with numbered settings. If the crimp height is not acceptable, adjust the ratchet as follows:

1. Remove the lock screw from the ratchet adjustment wheel.
2. With a screwdriver, adjust the ratchet wheel from the opposite side of the tool.
3. Observe the ratchet adjustment wheel. If a tighter crimp is required, rotate the adjustment wheel COUNTERCLOCKWISE to a higher-numbered setting. If a looser crimp is required, rotate the adjustment wheel CLOCKWISE to a lower-numbered setting.
4. Replace the lock screw.
5. Make a sample crimp and measure the crimp height. If the crimp height is acceptable, secure the lock screw. If the dimension is unacceptable, remove lock screw and continue to adjust the ratchet, and again measure a sample crimp.

## 6. MAINTENANCE AND INSPECTION

### 6.1. Daily Maintenance

It is recommended that each operator of the tool with the die assembly be made aware of, and responsible for, the following four steps of daily maintenance:

1. Remove dust, moisture, and other contaminants with a clean, soft brush, or a clean, soft, lint-free cloth. Do NOT use any objects that could damage the dies or tool.
2. Make sure that the proper die retaining screws are in place and secured.
3. Make certain that all surfaces are protected with a THIN coat of any good SAE 20 motor oil.

4. When the dies are not in use, mate and store them in a clean, dry area.

### 6.2. Periodic Inspections

Regular inspections should be performed by quality control personnel. A record of scheduled inspections should remain with the dies and/or be supplied to supervisory personnel responsible for the dies. Though recommendations call for at least one inspection per month, the inspection frequency should be based on amount of use, working conditions, operator training and skill, and established company standards. These inspections should be performed in the following sequence:

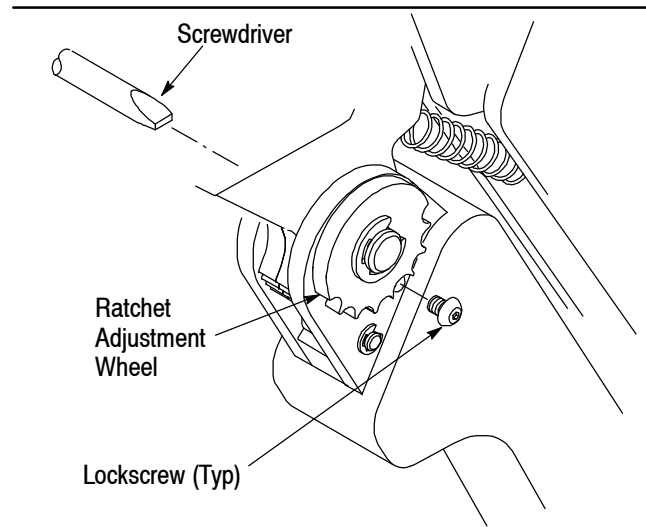

Figure 4

### A. Visual Inspection

1. Remove all lubrication and accumulated film by immersing the dies in a suitable commercial degreaser.
2. Make certain all die retaining screws and die components are in place and secured. If replacements are necessary, refer to Section 7, REPLACEMENT.
3. Inspect the crimp area for flattened, chipped, worn, cracked, or broken areas. If damage is evident, the dies must be replaced (see Section 7, REPLACEMENT).

### B. Gaging the Crimping Chamber

This inspection requires the use of a plug gage conforming to the diameters provided in Figure 5. TE does not manufacture, or market, these gages. Proceed as follows:

1. Mate the dies until it is evident that they have bottomed. Hold the dies in this position by holding the tool handles closed with moderate pressure.

2. Align the GO element of the gage with the crimping chamber. Push the element straight into the chamber without using force. The GO element must pass completely through the crimping chamber as shown in Figure 5.

3. Align the NO-GO element with the crimping chamber and try to insert it straight into the chamber. The NO-GO element may start entry but must not pass completely through. See Figure 5.

If the crimping chambers conform to the gage inspection, the dies are considered dimensionally correct and should be lubricated with a thin coat of any good SAE 20 motor oil. If not, the dies must be replaced before returning them to service.

For additional information concerning the use of the plug gage, refer to Instruction Sheet 408-7424.

### 7. REPLACEMENT

Parts listed in Figure 6 are customer-replaceable. A complete inventory can be stocked and controlled to prevent lost time when replacement of parts is necessary. Order replacements through your local TE Representative, or call 1-800-526-5142, or send a facsimile of your purchase order to 1-717-986-7605, or write to:

CUSTOMER SERVICE (38-35)  
 TYCO ELECTRONICS CORPORATION  
 P.O. BOX 3608  
 HARRISBURG, PA 17105-3608

### 8. REVISION SUMMARY

- Updated document to corporate requirements.

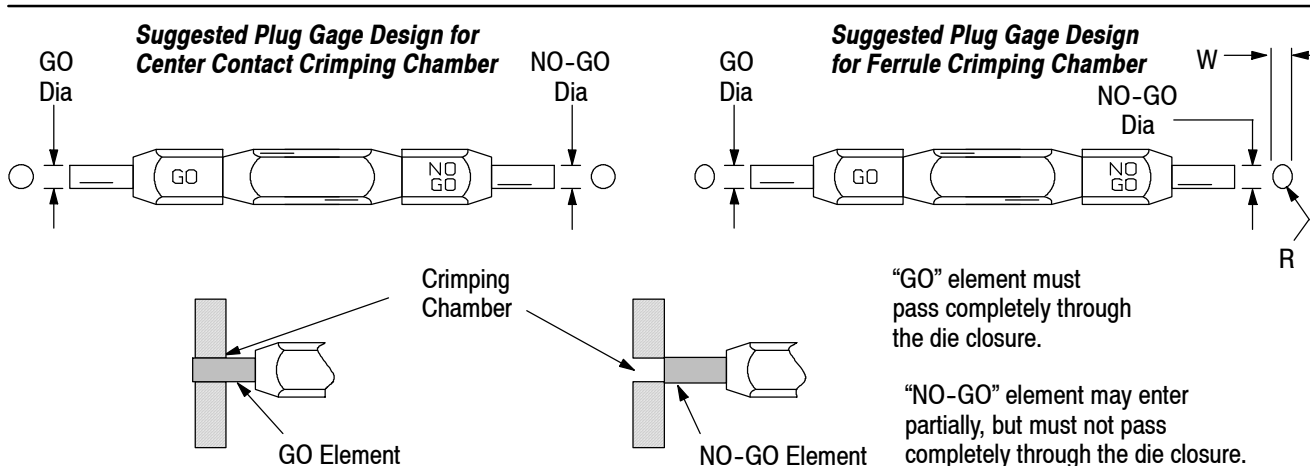

DIE ASSEMBLY PART NO.	GAGE ELEMENT DIAMETER (mm [in.])					
	CRIMPING CHAMBER					
	CENTER CONTACT		FERRULE			
	GO	NO-GO	GO	NO-GO	RADIUS "R" (Max)	WIDTH "W" (Max)
220189-1	1.207-1.214 [.0475-.0478]	1.359-1.367 [.0535-.0538]	5.156-5.164 [.2030-.2033]	5.408-5.410 [.2129-.2130]	2.51 [.099]	5.03 [.198]
220189-2	1.054-1.062 [.0415-.0418]	1.181-1.189 [.0465-.0468]	5.969-5.977 [.2350-.2353]	6.220-6.223 [.2449-.2450]	2.92 [.115]	5.84 [.230]
220189-3	1.925-1.928 [.0758-.0759]	1.984-1.986 [.0781-.0782]	5.405-5.408 [.2128-.2129]	5.667-5.669 [.2231-.2232]	2.64 [.104]	5.28 [.208]
58330-1	1.029-1.036 [.0405-.0408]	1.181-1.189 [.0465-.0468]	4.191-4.199 [.1650-.1653]	4.442-4.445 [.1749-.1750]	2.03 [.080]	4.06 [.160]

Figure 5

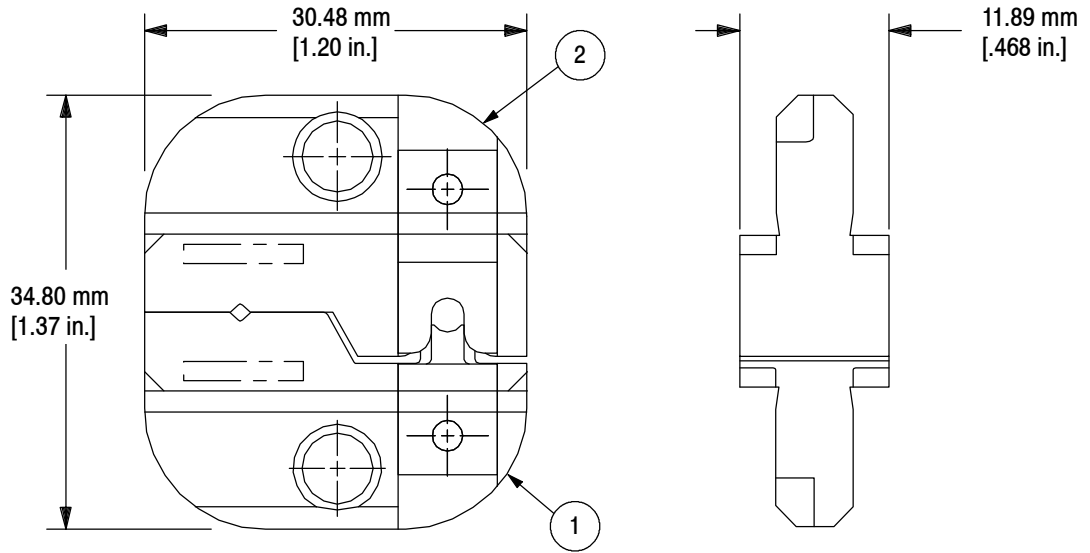

WEIGHT: 227 g [8 oz]

**CUSTOMER-REPLACEABLE PARTS**

DIE ASSEMBLY PART NO.	ANVIL (Item 1)	INDENTER (Item 2)
220189-1	310498-2	310497-2
220189-2	310498-4	310497-4
220189-3	310567-1	310568-1
58330-1	313764-1	313763-1

Figure 6

# Mouser Electronics

Authorized Distributor

Click to View Pricing, Inventory, Delivery & Lifecycle Information:

[TE Connectivity:](#)

[58330-1](#) [220189-1](#) [220189-2](#) [220189-3](#)