

High efficiency single inductor dual mode buck-boost DC-DC converter with 2.3 A switches peak current

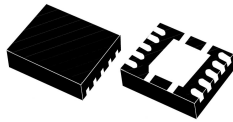

DFN10 3 x 3

Features

- Buck-boost DC-DC converter
- Operating input voltage range from 2.0 V to 5.5 V
- 2% DC feedback voltage tolerance
- Synchronous rectification
- Shutdown function
- 1.5 MHz switching frequency
- Power save mode at light load
- Typical efficiency: > 94%
- 2.3 A switches peak current limit at 3.3 V
- Shutdown current < 1 μ A
- Available in DFN10 (3 x 3 mm)

Applications

- Single cell Li-Ion and 3 cells alkaline, Ni-MH powered devices
- SD/MMC memory card supply
- Smart metering system
- Point of load regulation
- Portable equipment, IoT module

Maturity status link	
STBB1-AXX	
Device summary	
Order code	STBB1-APUR
Package	DFN10 (3 x 3 mm)
Packing	Tape and reel

Description

The **STBB1-AXX** is a fixed frequency, high efficiency, buck-boost DC-DC converter able to provide output voltages ranging from 1.2 V to 5.5 V and input voltages from 2.0 V to 5.5 V. The device can operate with input voltages higher than, equal to, or lower than the output voltage making the product suitable for single lithium-Ion, multicell alkaline or NiMH applications where the output voltage is within the battery voltage range. The integrated low- $R_{DS(on)}$ N-channel and P-channel MOSFET switches contribute to its high efficiency. The mode pin allows the selection between auto mode and forced PWM mode thus taking benefit either of lower power consumption or better dynamic performance. The device also includes soft-start control, thermal shutdown and current limit. The **STBB1-AXX** is packaged in DFN10 (3 x 3 mm).

1 Block diagram

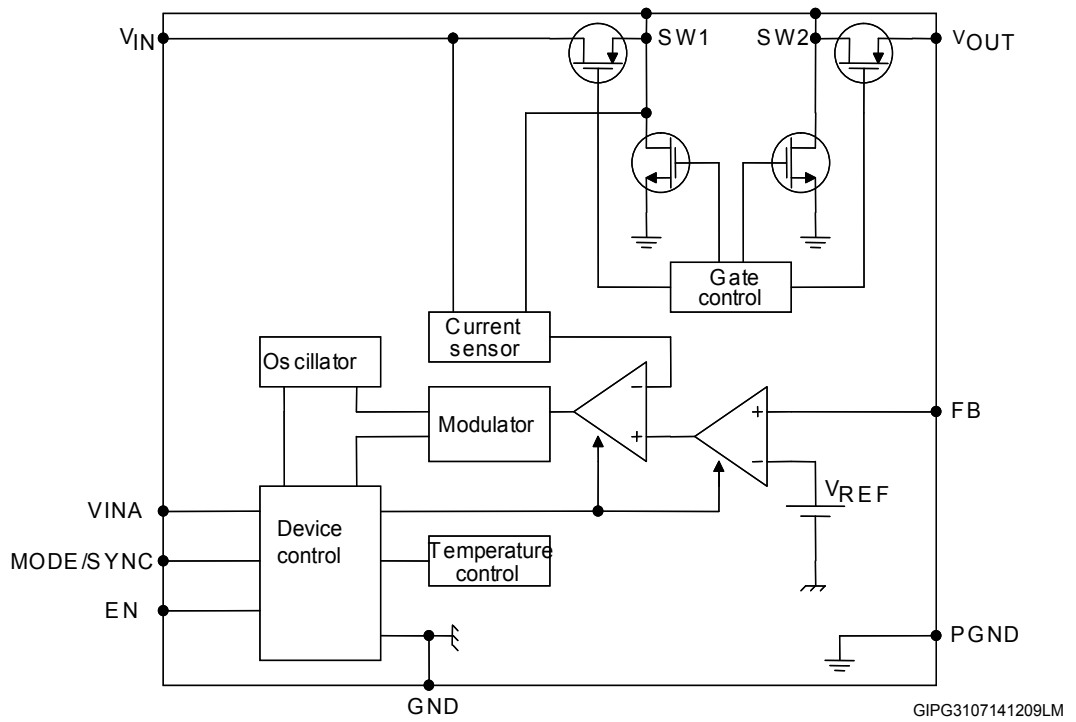
Figure 1. STBB1-AXX block diagram

2 Absolute maximum ratings

Table 1. Absolute maximum ratings

Symbol	Parameter	Value	Unit
VINA, VIN	Input voltage	-0.3 to 7	V
VOUT	Output voltage	-0.3 to 7	V
SW1, SW2	DC voltage	-0.3 to 7	V
FB	DC voltage	-0.3 to 1.5	V
MODE/SYNC, EN	DC voltage	-0.3 to 7	V
T _J	Maximum junction temperature	150	°C
T _{STG}	Storage temperature range	-65 to +150	°C
T _{JOP}	Operating junction temperature range	-40 to +85	°C
ESD	Human body model	2	kV

Note: Absolute maximum ratings are those values beyond which damage to the device may occur. Functional operation under these conditions is not implied.

Table 2. Thermal data

Symbol	Parameter	Value	Unit
R _{THJC}	Thermal resistance junction-case	2.96	°C/W
R _{THJA}	Thermal resistance junction-ambient	30.9	°C/W

3 Pin configuration

Figure 2. Pin connection (top view)

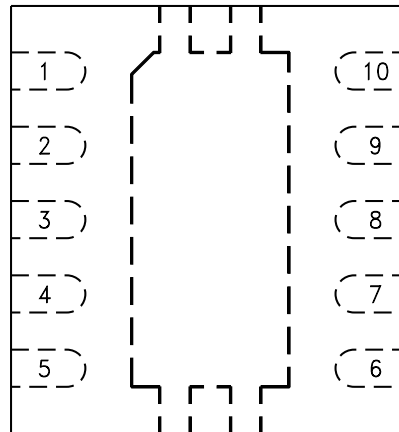

Table 3. Pin description

Pin	Symbol	Name and function
1	VOUT	Output voltage
2	SW2	Switch pin. Internal switches are connected to this pin. Connect inductor between SW1 to SW2
3	PGND	Power ground
4	SW1	Switch pin. Internal switches are connected to this pin. Connect inductor between SW1 and SW2
5	VIN	Power input voltage. Connect a ceramic bypass capacitor (10 μ F minimum) between this pin and PGND
6	EN	Enable pin. Connect this pin to GND or a voltage lower than 0.4 V to shut down the IC. A voltage higher than 1.2 V is required to enable the IC
7	MODE /SYNC	Operation mode selection. If MODE pin is low, the STBB1-AXX automatically switches between pulse skipping and fixed frequency PWM according to the load level. If MODE pin is pulled high, the STBB1-AXX works in PWM mode. When a square waveform is applied, this pin provides the clock signal for oscillator synchronization
8	VINA	Supply voltage for control stage
9	GND	Signal ground
10	FB	Feedback voltage
	Exposed pad	Power ground

4 Typical application

Figure 3. Application circuit (adjustable output version)

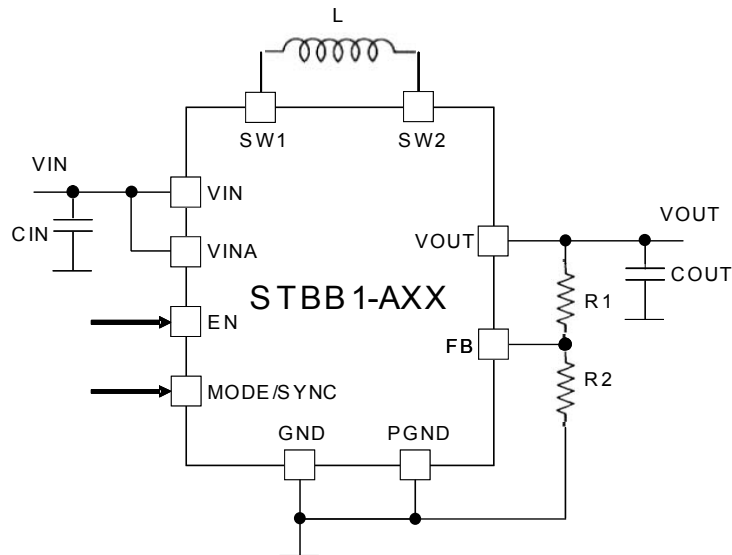

Table 4. List of external components

Component	Manufacturer	Part number	Value	Size
CIN	Murata	GRM21BR71A106KE51L	10 μ F	0805
COUT	Murata	GRM21BR60J226ME39L	22 μ F	0805
L	TDK	VLCF4020T-2R2N1R7	2.2 μ H	4x4x2
	Coilcraft	XFL4020-222ME		4x4x2
R1 ⁽¹⁾		560 k Ω ($V_O = 3.3$ V)	See below note	0402
R2 ⁽¹⁾		100 k Ω		0402

1. R1 and R2 are calculated according to the following formula: $R1 = R2 \times (V_{OUT}/V_{FB} - 1)$. Suggested value for R2 is 100 k Ω . In order to reduce the quiescent current a maximum value of 500 k Ω is possible.

Note: The above listed components refer to a typical application. The STBB1-AXX operation is not limited to the choice of these components.

5 Electrical characteristics

$V_{IN} = V_{INA} = V_{EN} = 3.6\text{ V}$, $C_{IN} = 10\text{ }\mu\text{F}$, $C_{OUT} = 10\text{ }\mu\text{F}$, $L = 2.2\text{ }\mu\text{H}$, $T_J = -40\text{ to }85\text{ }^\circ\text{C}$ (unless otherwise specified; typical values are referred to $T_A = 25\text{ }^\circ\text{C}$).

Table 5. Electrical characteristics

Symbol	Parameter	Test conditions	Min.	Typ.	Max.	Unit
V_{IN}	Input voltage range		2.0		5.5	V
V_{UVLO}	Undervoltage lockout threshold	V_{INA} rising		1.70	1.80	V
		V_{INA} falling	1.50	1.60		
V_{FB}	Feedback voltage		485	500	515	mV
		$T_J = 25\text{ }^\circ\text{C}$	490	500	510	mV
V_{OUT}	Output voltage range		1.2		5.5	V
Z_{FB}	FB input impedance			10		M Ω
I_Q	No switching quiescent current ($V_{IN}+V_{INA}$) (see Figure 3. Application circuit (adjustable output version))	$FB = 0.7\text{ V}$, $V_{MODE} = 0\text{ V}$		160	250	μA
		$FB = 0.7\text{ V}$, $V_{MODE} = V_{IN}$		600	750	
I_Q	Operating quiescent current ($V_{IN}+V_{INA}$)	$I_{OUT} = 0\text{ A}$, $V_{OUT} = 3.3\text{ V}$, $V_{MODE} = 0\text{ V}$		200		μA
		$I_{OUT} = 0\text{ A}$, $V_{OUT} = 3.3\text{ V}$, $V_{MODE} = V_{IN}$		3.4	5.0	mA
I_{QSHDN}	Shutdown quiescent current	$V_{EN} = 0\text{ V}$, $V_{IN} = 3.6\text{ V}$		0.1	1	μA
freq	Oscillator frequency	$T_A = 25\text{ }^\circ\text{C}$	1300	1500	1750	kHz
	Frequency range for synchronization		1300		2000	
V_{EN}	Enable input logic low	$V_{IN} = 2.2\text{ V to }5.5\text{ V}$			0.4	V
	Enable input logic high	$V_{IN} = 2.2\text{ V to }5.5\text{ V}$	1.2			
I_{EN}	Enable pin current	$V_{EN} = 5.5\text{ V}$		0.01	1	μA
$V_{MODE/SYNC}$	MODE/SYNC input logic low	$V_{IN} = 2.2\text{ V to }5.5\text{ V}$			0.4	V
	MODE/SYNC input logic high	$V_{IN} = 2.2\text{ V to }5.5\text{ V}$	1.2			
$I_{MODE/SYNC}$	MODE/SYNC pin current	$V_{MODE/SYNC} = 5.5\text{ V}$		0.01	1	μA
$\%V_{OUT}$	Line regulation	$2.2\text{ V} < V_{IN} < 5.5\text{ V}$; $I_{OUT} = 1\text{ mA}$		0.5		%
$\%V_{OUT}$	Load regulation	$10\text{ mA} < I_{OUT} < 1000\text{ mA}$		1		%
I_{SWL}	Switch current limitation	$V_{IN} = 3.3\text{ V}$	1.6	2.3	2.6	A
I_{LKN}	NMOS leakage current	$V_{IN} = 5.5\text{ V}$		0.01	1	μA
I_{LKP}	PMOS leakage current			0.01	1	μA
$R_{DS(on)-N}$	NMOS switch on resistance			0.13	0.35	Ω
$R_{DS(on)-P}$	PMOS switch on resistance			0.13	0.35	Ω

Symbol	Parameter	Test conditions	Min.	Typ.	Max.	Unit
n	Efficiency, $V_{IN} = 3.6\text{ V}$, $V_{OUT} = 3.3\text{ V}$	$I_{OUT} = 10\text{ mA}$; $V_{MODE} = 0$		89		%
		$I_{OUT} = 10\text{ mA}$; $V_{MODE} = V_{IN}$		67		
		$I_{OUT} = 100\text{ mA}$; $V_{MODE} = V_{IN}$		94		
T_{SHDN}	Thermal shutdown			140		°C
T_{HYS}	Thermal shutdown hysteresis			20		°C

6 Detailed description

6.1 General description

The STBB1-AXX is a high efficiency dual mode buck-boost switch mode converter. Thanks to the 4 internal switches, 2 P-channel and 2 N-channel, and its unique control mechanisms the device can deliver a well-regulated output voltage using a variable input voltage which can be higher than, equal to or lower than the desired output voltage. This solves most of the power supply problems that circuit designers face when dealing with battery-powered equipment.

The controller uses an average current mode technique to obtain good stability in all possible conditions of input voltage, output voltage and output current. In addition, the peak inductor current is monitored to avoid saturation of the coil.

The STBB1-AXX can work in two different modes: PWM mode or power save mode. The former operates with a fixed oscillator frequency in all line/load conditions. This is the best condition to obtain the maximum dynamic performance. The latter operates in burst mode allowing a drastic reduction of power consumption.

Top-class line and load transients are achieved thanks to feed-forward technique and due to the innovative control method specifically designed to optimize the performance in the buck-boost region where input voltage is very close to the output voltage.

The STBB1-AXX is self-protected from short-circuit and overtemperature.

Undervoltage lockout and soft-start guarantee proper operation during the startup.

Input voltage and ground connections are split into power and signal pins. This allows reduction of internal disturbances when the 4 internal switches are being worked. The switch bridge is connected between VIN and PGND pins while all logic blocks are connected between VINA and GND.

6.2 Dual mode operation

The STBB1-AXX works in PWM or in power save (PS) mode according to the different operating conditions.

If MODE pin is pulled high, the device works in PWM mode only even at light or no load. In this condition the STBB1-AXX provides the best dynamic performance.

If the MODE pin is logic low, the STBB1-AXX operation changes according to the average input current handled by the device.

At low average current the STBB1-AXX enters PS mode allowing very low power consumption and thus obtaining very good efficiency at light load. When the average current increases, the device automatically switches to PWM mode to deliver the power needed by the load.

In PS mode the STBB1-AXX implements a burst mode operation. If the output voltage increases above its nominal value the device stops switching. As soon as V_{OUT} falls below the nominal value the device starts switching again with a programmed average current higher than the one needed by the load. not found in not found shows PS mode operation areas vs. output current in typical application conditions.

6.3 External synchronization

The STBB1-AXX implements the external synchronization pin. If an external clock signal is applied to the MODE (SYN) pin with a frequency between 1.35 MHz and 2.0 MHz and with proper low/high levels, the device automatically goes to PWM mode and the external clock is used as switching oscillator.

6.4 Enable pin

The device operates when EN pin is set high. If EN pin is set low the device stops switching, all the internal blocks are turned off. In this condition, the current drawn from VIN/VINA is below 1 μ A in the whole temperature range. In addition, the internal switches are in off-state so the load is electrically disconnected from the input, by avoiding unwanted current leakage from the input to the load.

6.5 Protection features

The STBB1-AXX implements different types of protection features.

6.5.1 Soft-start and short-circuit

After EN pin is pulled high, or after a suitable voltage is applied to VIN, VINA and EN, the device initiates the start-up phase. The average current limit is set to 400 mA at the beginning and gradually rises while the output voltage increase is being tracked. As soon the output voltage reaches 1.0 V the average current limit is set to its nominal value.

This method allows a current limit proportional to the output voltage. If there is a short in the V_{OUT} pin, the output current doesn't exceed 400 mA.

This process is not handled by a timer so the device is also able to start even with large capacitive loads.

6.5.2 Undervoltage lockout

The undervoltage lockout function prevents improper operation of the STBB1-AXX when the input voltage is not high enough. When the input voltage is below VUVLO threshold the device is in shutdown mode. The hysteresis of 100 mV prevents unstable operation when the input voltage is close to UVLO threshold.

6.5.3 Overtemperature protection

An internal temperature sensor continuously monitors the IC junction temperature. If the IC temperature exceeds 140 °C typically the device stops operating. As soon as the temperature falls below 120 °C typically normal operation is restored.

7 Typical performance characteristics

$L = 2.2 \mu\text{H}$, $V_O = 3.3 \text{ V}$, all measurements are fulfilled with circuit shown in Figure 3. Application circuit (adjustable output version) and external components listed in Table 4.

Figure 4. Efficiency vs. I_{OUT} in auto mode

Figure 5. Efficiency vs. I_{OUT} in PWM mode

Figure 6. Efficiency vs. V_{IN} , $I_{OUT} = 500 \text{ mA}$

Figure 7. PS to PWM transition

Figure 8. Maximum I_{OUT} vs. V_{IN}

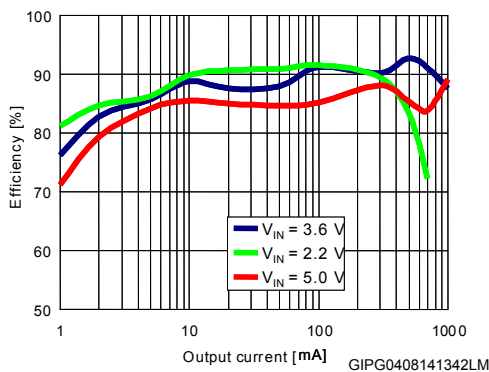
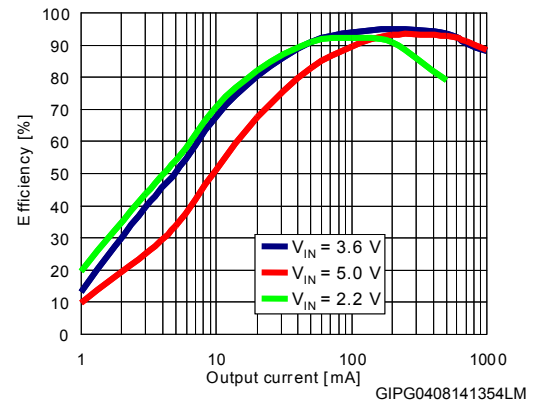
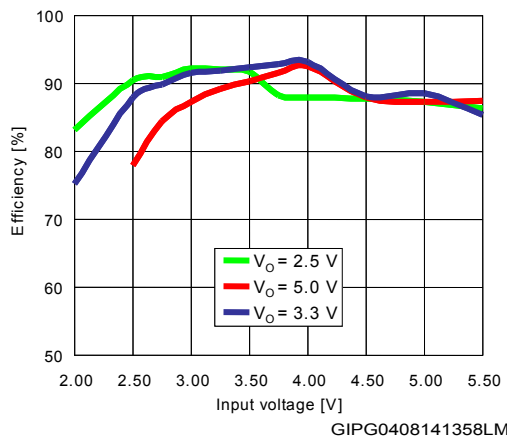
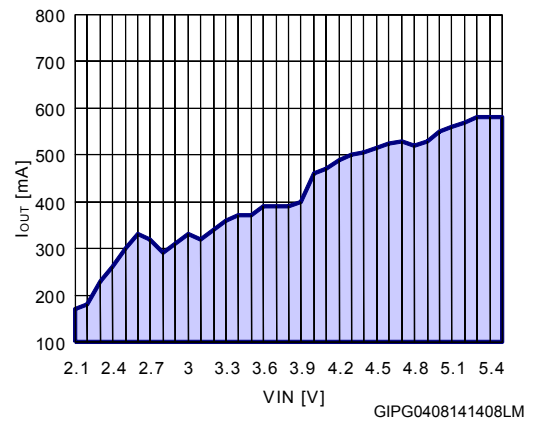
Figure 9. Boost region operation

 $V_{IN} = 2.5\text{ V}$, $V_O = 3.3\text{ V}$, $I_O = 50\text{ mA}$ pulse skipping

Figure 10. Boost region operation $I_O = 200\text{ mA}$

 $V_{IN} = 2.5\text{ V}$, $V_O = 3.3\text{ V}$, $I_O = 200\text{ mA}$ PWM mode

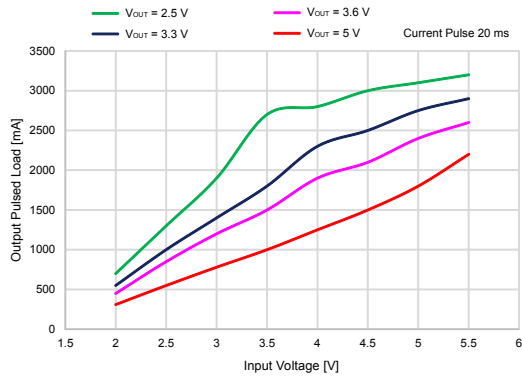
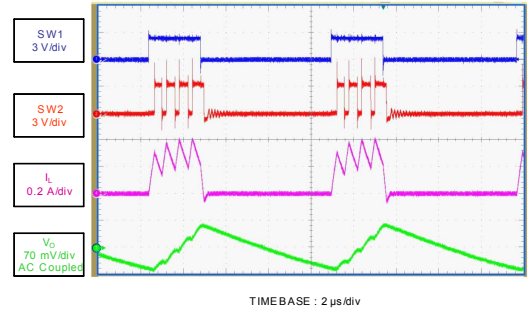
Figure 11. Buck-boost region operation

 $V_{IN} = 3.6\text{ V}$, $V_O = 3.3\text{ V}$, $I_O = 100\text{ mA}$, pulse skipping mode

GIPG0408141513LM

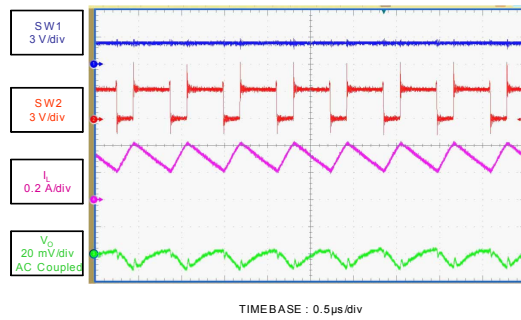
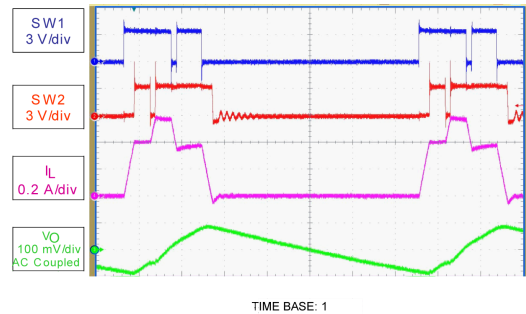
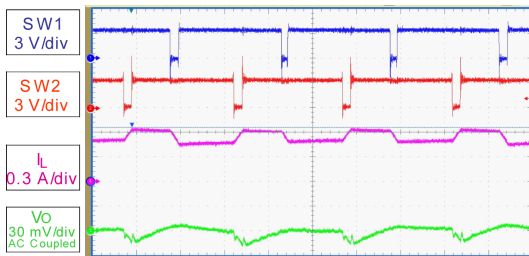
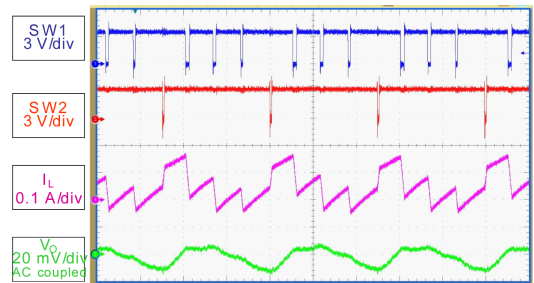
Figure 12. Buck-boost region operation @ $I_O = 500\text{ mA}$

 $V_{IN} = 3.6\text{ V}$, $V_O = 3.3\text{ V}$, $I_O = 500\text{ mA}$, PWM mode

GIPG0508140918LM

Figure 13. Buck-boost region operation @ $I_O = 50\text{ mA}$

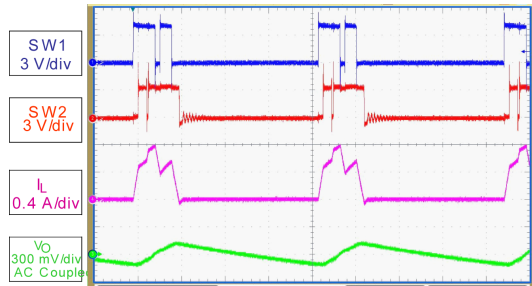
 $V_{IN} = 3.6\text{ V}$, $V_O = 3.3\text{ V}$, $I_O = 50\text{ mA}$, PWM mode

GIPG0508141000LM

Figure 14. Buck region operation (skipping mode)

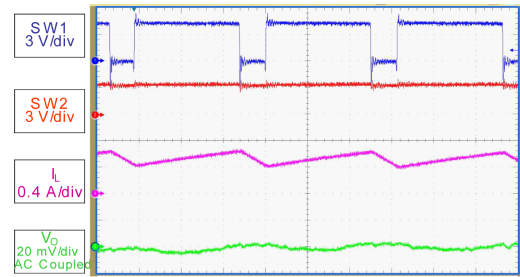
TIMEBASE: 2 μ s/div
 VIN = 4.2 V VO = 3.3 V IO = 100 mA, pulse skipping mode
 GIPG0508141009LM

Figure 15. Buck region operation (PWM mode)

TIMEBASE: 0.2 μ s/div
 VIN = 4.2 V VO = 3.3 V IO = 500 mA, PWM mode
 GIPG0508141013LM

8 Application information

8.1 Programming the output voltage

The STBB1-AXX is available in two versions: fixed output voltage (STBB1-APURXX) and adjustable output voltage (STBB1-APUR). The former integrates the resistor divider needed to set the correct output voltage. This allows 2 external components to be saved. The FB pin must be connected directly to V_{OUT} .

Regarding to the adjustable version, the resistor divider must be connected between V_{OUT} and GND and the middle point of the divider has to be connected to FB as shown in [Figure 3. Application circuit \(adjustable output version\)](#)

Equation 1

$$R1 = R2 \cdot \left(\frac{V_{OUT}}{V_{FB}} - 1 \right)$$

A suggested value for R2 is 100 kΩ. To reduce the power consumption a maximum value of 500 kΩ can be used.

8.2 Inductor selection

The inductor is the key passive component for switching converters. With a buck-boost device, the inductor selection must take into consideration the boundary conditions in which the converter works, as buck at the maximum input voltage and as a boost at the minimum input voltage. Two critical inductance values are then obtained according to the following formulas:

equation 2

$$L_{MIN-BUCK} = \frac{V_{OUT} \cdot (V_{IN_{MAX}} - V_{OUT})}{V_{IN_{MAX}} \cdot f_s \cdot \Delta I_L}$$

equation 3

$$L_{MIN-BOOST} = \frac{V_{IN_{MIN}} \cdot (V_{OUT} - V_{IN_{MIN}})}{V_{OUT} \cdot f_s \cdot \Delta I_L}$$

where:

f_s : minimum switching frequency

ΔI_L = the peak-to-peak inductor ripple current. As a rule of thumb, the peak-to-peak ripple can be set at 10% - 20% of the output current. The minimum inductor value for the application is the highest between the above equations. Furthermore, the maximum current the inductor can handle must be calculated in order to avoid saturation.

equation 4

$$I_{PEAK-BUCK} = I_{OUT}/\eta + \frac{V_{OUT} \cdot (V_{IN_{MAX}} - V_{OUT})}{2 \cdot V_{IN_{MAX}} \cdot f_s \cdot L}$$

equation 5

$$I_{PEAK-BOOST} = \frac{V_{OUT} \cdot I_{OUT}}{\eta \cdot V_{IN_{MIN}}} + \frac{V_{IN_{MIN}} \cdot (V_{OUT} - V_{IN_{MIN}})}{2 \cdot V_{OUT} \cdot f_s \cdot L}$$

where η is the estimated efficiency of the STBB1-AXX. The maximum of the two values above must be considered when the inductor is selected.

8.3 Input and output capacitor selection

Ceramic capacitors should be with low ESR in order to filter any disturbance present in the input line and to obtain stable operation. Minimum values of 10 μF for both capacitors are needed to achieve good behavior of the device. The input capacitor has to be placed as closer as possible to the device.

9 Recommended PCB layout

Figure 20. Component placement

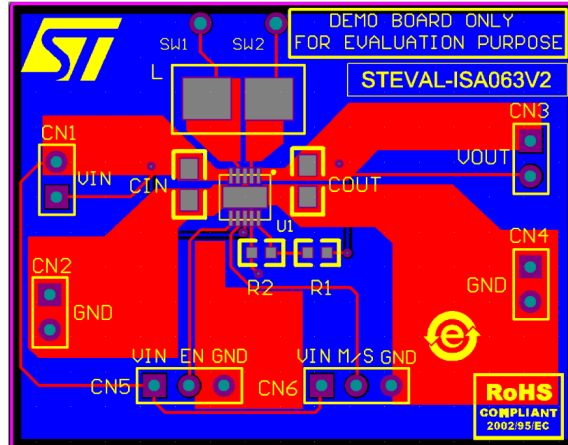

Figure 21. Top layer routing

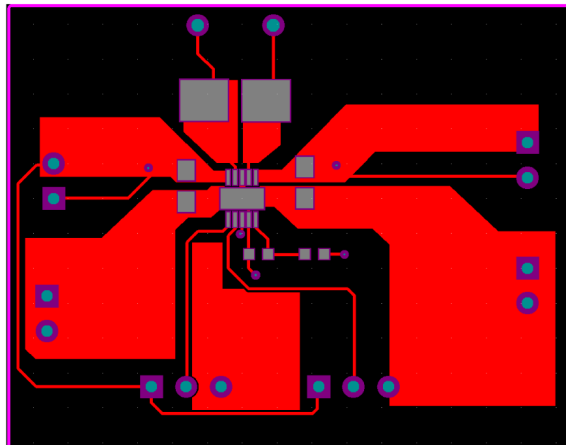
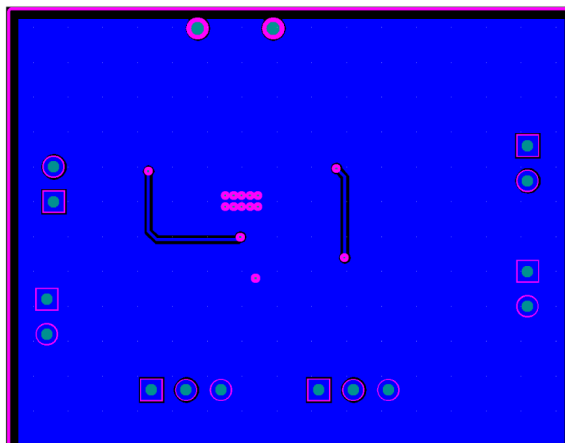

Figure 22. Bottom layer routing



10 Package mechanical data

In order to meet environmental requirements, ST offers these devices in different grades of ECOPACK® packages, depending on their level of environmental compliance. ECOPACK® specifications, grade definitions and product status are available at: www.st.com. ECOPACK® is an ST trademark.

10.1 DFN10 (3 x 3 mm) mechanical data

Figure 23. DFN10 (3 x 3 mm) package outline

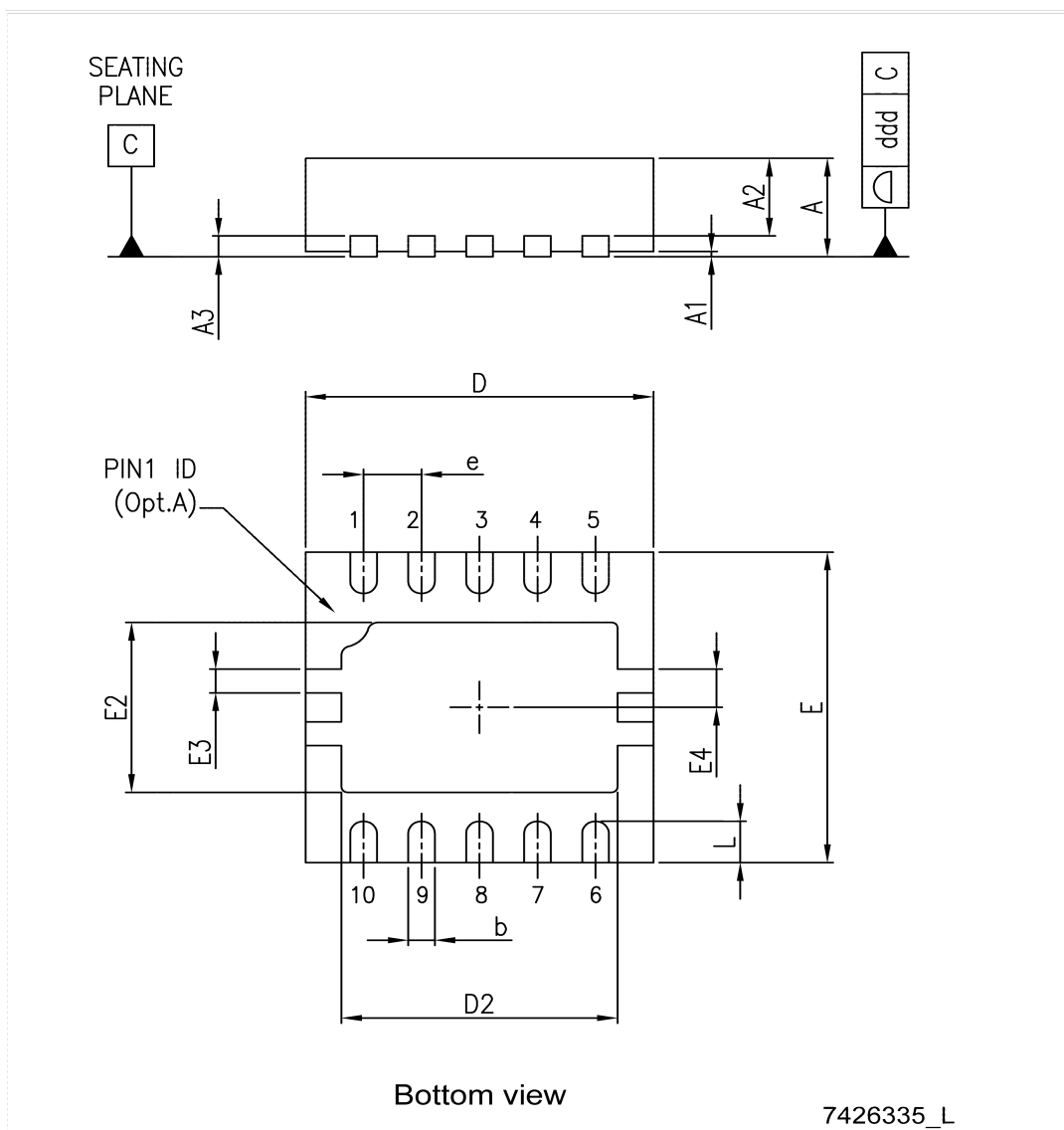

Table 6. DFN10 (3 x 3 mm) package mechanical data

Dim.	mm		
	Typ.	Min.	Max.
A	0.90	0.80	1.00
A1 ⁽¹⁾	0.02		00.5
A2	0.70		
A3 ⁽¹⁾	0.20		
b	0.23	0.18	0.30
D	3.00	2.85	3.15

Dim.	mm		
	Typ.	Min.	Max.
D2	2.38	2.23	2.50
E	3.00	2.85	3.15
E2	1.64	1.49	1.75
E3		0.230	
E4		0.365	
e	0.50		
L	0.40	0.30	0.50
ddd			0.08

1. The size is related to all leads, including exposed pad terminals.

Figure 24. DFN10 (3 x 3 mm) recommended footprint

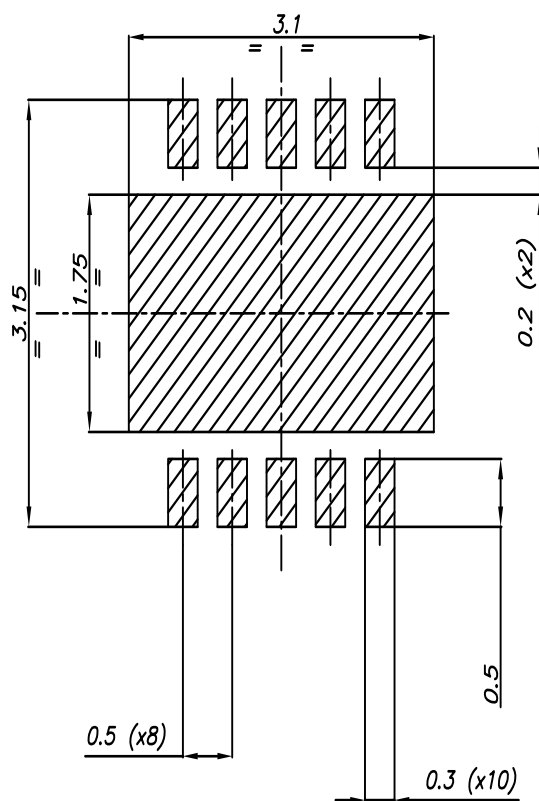

Revision history

Table 7. Document revision history

Date	Revision	Changes
07-Sep-2011	1	Initial release.
04-Oct-2011	2	Added condition $T_A = 25\text{ °C}$ for the oscillator frequency parameter in table 6.
04-Aug-2014	3	Changed mechanical data.
29-Oct-2014	4	Updated mechanical data. Inserted device summary table. Deleted "application circuit (fixed output version)" figure.
06-Mar-2018	5	Updated: title and features on the cover page, Figure 8. Maximum I_{OUT} vs. V_{IN} .

Contents

1	Block diagram	2
2	Absolute maximum ratings	3
3	Pin configuration	4
4	Typical application	5
5	Electrical characteristics	6
6	Detailed description	8
6.1	General description	8
6.2	Dual mode operation	8
6.3	External synchronization	8
6.4	Enable pin	8
6.5	Protection features	8
6.5.1	Soft-start and short-circuit	9
6.5.2	Undervoltage lockout	9
6.5.3	Overtemperature protection	9
7	Typical performance characteristics	10
8	Application information	13
8.1	Programming the output voltage	13
8.2	Inductor selection	13
8.3	Input and output capacitor selection	13
9	Recommended PCB layout	15
10	Package mechanical data	16
10.1	DFN10 (3 x 3 mm) mechanical data	17
	Revision history	19
	Contents	20
	List of tables	21
	List of figures	22
	Disclaimer	23

List of tables

Table 1.	Absolute maximum ratings	3
Table 2.	Thermal data	3
Table 3.	Pin description	4
Table 4.	List of external components	5
Table 5.	Electrical characteristics	6
Table 6.	DFN10 (3 x 3 mm) package mechanical data	17
Table 7.	Document revision history	19

List of figures

Figure 1.	STBB1-AXX block diagram	2
Figure 2.	Pin connection (top view)	4
Figure 3.	Application circuit (adjustable output version)	5
Figure 4.	Efficiency vs. I_{OUT} in auto mode	10
Figure 5.	Efficiency vs. I_{OUT} in PWM mode	10
Figure 6.	Efficiency vs. V_{IN} , $I_{OUT} = 500$ mA	10
Figure 7.	PS to PWM transition	10
Figure 8.	Maximum I_{OUT} vs. V_{IN}	11
Figure 9.	Boost region operation.	11
Figure 10.	Boost region operation $I_O=200$ mA	11
Figure 11.	Buck-boost region operation	11
Figure 12.	Buck-boost region operation @ $I_O = 500$ mA	11
Figure 13.	Buck-boost region operation @ $I_O = 50$ mA	11
Figure 14.	Buck region operation (skipping mode)	12
Figure 15.	Buck region operation (PWM mode)	12
Figure 20.	Component placement.	15
Figure 21.	Top layer routing	15
Figure 22.	Bottom layer routing	15
Figure 23.	DFN10 (3 x 3 mm) package outline	17
Figure 24.	DFN10 (3 x 3 mm) recommended footprint.	18

IMPORTANT NOTICE – PLEASE READ CAREFULLY

STMicroelectronics NV and its subsidiaries (“ST”) reserve the right to make changes, corrections, enhancements, modifications, and improvements to ST products and/or to this document at any time without notice. Purchasers should obtain the latest relevant information on ST products before placing orders. ST products are sold pursuant to ST’s terms and conditions of sale in place at the time of order acknowledgement.

Purchasers are solely responsible for the choice, selection, and use of ST products and ST assumes no liability for application assistance or the design of Purchasers’ products.

No license, express or implied, to any intellectual property right is granted by ST herein.

Resale of ST products with provisions different from the information set forth herein shall void any warranty granted by ST for such product.

ST and the ST logo are trademarks of ST. All other product or service names are the property of their respective owners.

Information in this document supersedes and replaces information previously supplied in any prior versions of this document.

© 2018 STMicroelectronics – All rights reserved