

KEMET Part Number: SHBC8S-0R6A0024V
(UALS8S0R6A0024)

KEMET, SHBC, AC Line Filters, Normal Mode, 24 uH, 20%

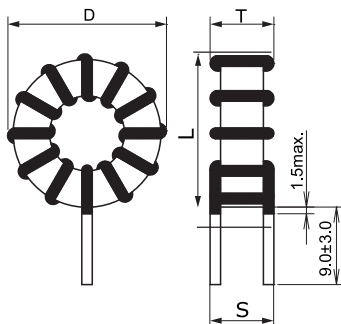

Dimensions	
D	16mm MAX
L	16mm MAX
T	16mm MAX
LL	9mm +/-3mm
S	7mm NOM

Packaging Specifications	
Packaging:	Tray
Packaging Quantity:	700
Weight:	4 g

General Information	
Series:	SHBC
Style:	Through-Hole
Features:	Low Core Loss, High Frequency Drive
RoHS:	Yes
Miscellaneous:	15 (K) Temperature Rise Max.

Specifications	
Inductance:	24 uH
Inductance Tolerance:	20%
Current:	2 A
Temperature Range:	-40/+125°C
DC Resistance:	41.1 mOhms