

KEMET Part Number: SSRH24NH-12655
(UALS24H1265500)

KEMET, SSRH24NV/NH, AC Line Filters, Common Mode, 0.0655 H

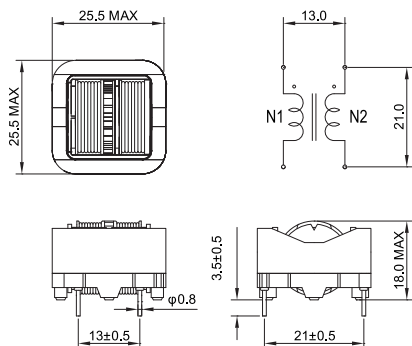

Dimensions

L	25.5mm MAX
T	25.5mm MAX
H	18mm MAX
LL	3.5mm +/-0.5mm
S	13mm NOM

Packaging Specifications

Packaging:	Tray
Packaging Quantity:	300
Weight:	22.5 g

General Information

Series:	SSRH24NV/NH
Style:	Through-Hole
Features:	Compact Size, Light Weight, Low Rdc, Ultra-High Impedance
RoHS:	Yes
Miscellaneous:	65 (K) Temperature Rise Max.

Specifications

Voltage AC:	250 VAC
Inductance:	65.5 mH (10 kHz)
Current:	1.2 A
Temperature Range:	-25/+120°C
DC Resistance:	475 mOhms