

PROTECTION PRODUCTS - TransClamp™

Description

A TransClamp™ is a low capacitance TVS array designed to protect high speed data interfaces. This series has been specifically designed to protect sensitive components which are connected to data and transmission lines from overvoltage caused by **ESD** (electrostatic discharge), **CDE** (Cable Discharge Events), and **Lightning**.

These devices integrate low capacitance, surge-rated compensation diodes with a high power transient voltage suppressor (TVS). The compensation diodes are arranged in a bridge pattern allowing the device to be connected in common mode and/or differential mode. This allows the designer maximum flexibility and reduces parts count. The capacitance of the device is limited to 12pF maximum from line-to-line to ensure correct signal transmission on high-speed lines.

These devices may be used to meet Telcordia GR-1089-CORE short-haul (intra-building) surge requirements and will withstand a minimum 100 A surge for a 2/10µs pulse.

The TClamp™3302N is in a 10-pin, RoHS/WEEE compliant, SLP2626P10 package. It measures 2.6 x 2.6 x 0.60mm. The leads are spaced at a pitch of 0.5mm and are finished with lead-free NiPdAu. They are particularly well suited for applications where board space is at a premium such as integrated connectors/magnetics and carrier class Ethernet equipment.

Features

- ◆ Transient protection for high-speed data lines to **Bellcore 1089 (Intra-Building) 100A (2/10µs)**
IEC 61000-4-2 (ESD) ±15kV (air), ±8kV (contact)
IEC 61000-4-4 (EFT) 40A (5/50ns)
IEC 61000-4-5 (Lightning) L5, 95A (8/20µs)
- ◆ Low capacitance (12pF line-to-line)
- ◆ Low operating voltages (**3.3V**)
- ◆ Low clamping voltage
- ◆ Small SLP Package saves board space
- ◆ Solid-state technology

Mechanical Characteristics

- ◆ SLP2626P10 10L package
- ◆ RoHS/WEEE Compliant
- ◆ Nominal Dimensions: 2.6 x 2.6 x 0.60 mm
- ◆ Lead Pitch: 0.5mm
- ◆ Molding compound flammability rating: UL 94V-0
- ◆ Marking: Marking Code
- ◆ Packaging: Tape and Reel

Applications

- ◆ 10/100/1000 Ethernet
- ◆ T3/E3
- ◆ Integrated Magnetics
- ◆ Carrier Class Equipment
- ◆ Customer Premise Equipment

Circuit Diagram

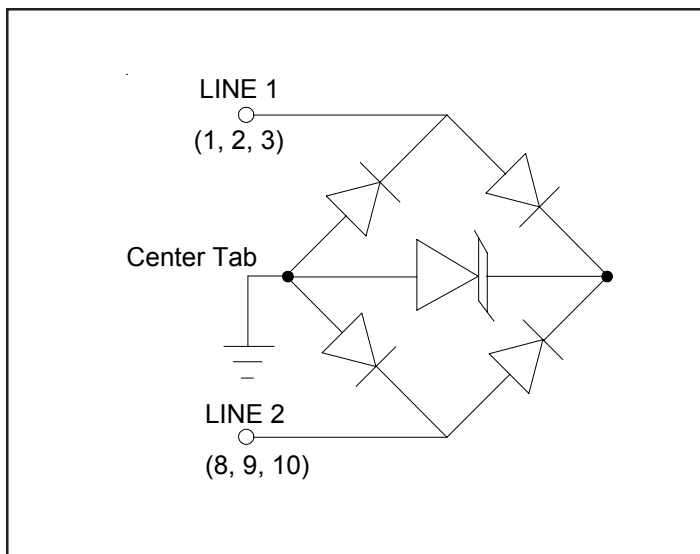

Package Configuration

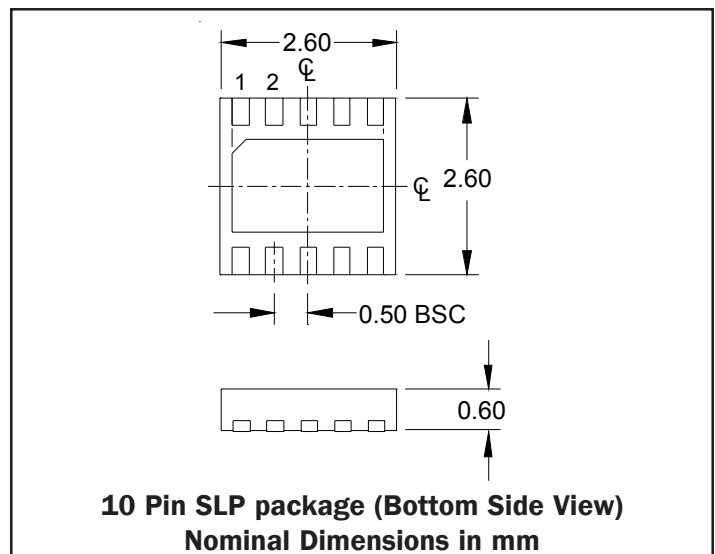

PROTECTION PRODUCTS
Absolute Maximum Rating

Rating	Symbol	Value	Units
Peak Pulse Power (tp = 2/10μs)	P_{pk}	2500	Watts
Peak Pulse Current (tp = 2/10μs)	I_{pp}	120	A
Peak Pulse Current (tp = 8/20μs)	I_{pp}	95	A
ESD per IEC 61000-4-2 (Air) ESD per IEC 61000-4-2 (Contact)	V_{ESD}	30 30	kV
Operating Temperature	T_J	-40 to +85	°C
Storage Temperature	T_{STG}	-55 to +150	°C

Electrical Characteristics (T=25°C unless otherwise specified)

TClamp3302N						
Parameter	Symbol	Conditions	Minimum	Typical	Maximum	Units
Reverse Stand-Off Voltage	V_{RWM}	T=25°C to 85°C			3.3	V
Punch-Through Voltage	V_{PT}	$I_{PT} = 2\mu A$ T=25°C	3.5			V
Snap-Back Voltage	V_{SB}	$I_{SB} = 50mA$	2.8			V
Reverse Leakage Current	I_R	$V_{RWM} = 3.3V$, T=25°C			1	μA
Clamping Voltage	V_C	$I_{pp} = 100A$, tp = 2/10μs Line-to-Ground			22	V
Clamping Voltage	V_C	$I_{pp} = 100A$, tp = 2/10μs Line-to-Line			25	V
Junction Capacitance	C_J	Between I/O pins and Gnd $V_R = 0V$, f = 1MHz			25	pF
		Between I/O pins $V_R = 0V$, f = 1MHz			12	pF

PROTECTION PRODUCTS

Typical Characteristics

Non-Repetitive Peak Pulse Power vs. Pulse Time

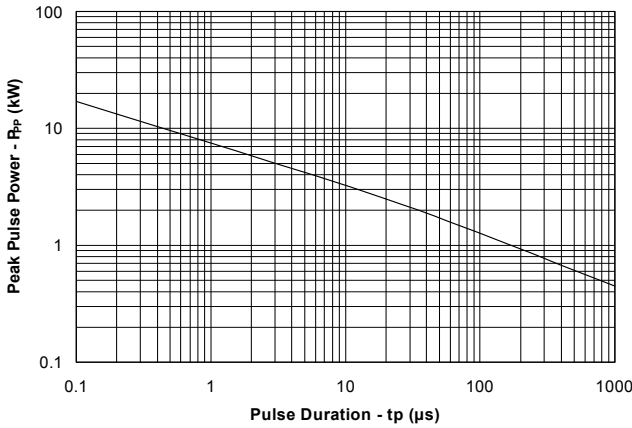

Power Derating Curve

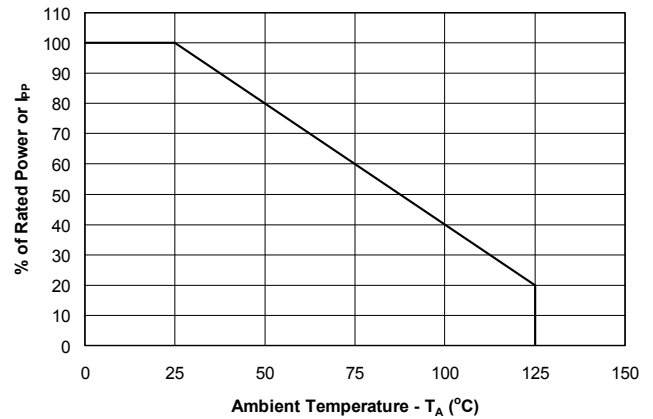

Normalized Junction Capacitance vs. Reverse Voltage (Line-to-Line)

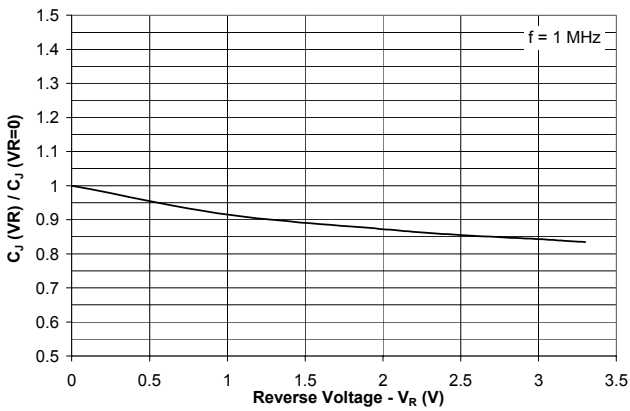

Normalized Junction Capacitance vs. Reverse Voltage (Line-to-Ground)

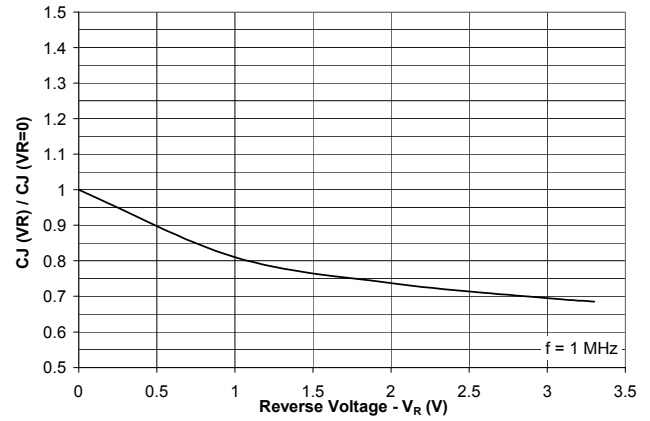

Clamping Voltage vs. Peak Pulse Current

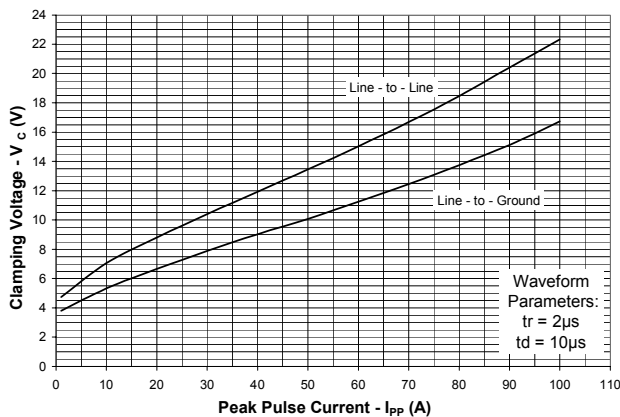

Normalized Junction Capacitance vs. Temperature

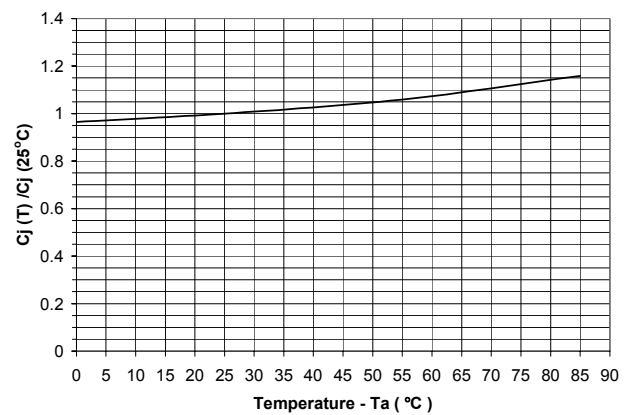

PROTECTION PRODUCTS

Typical Characteristics

Typical Insertion Loss S21 (Each Line)

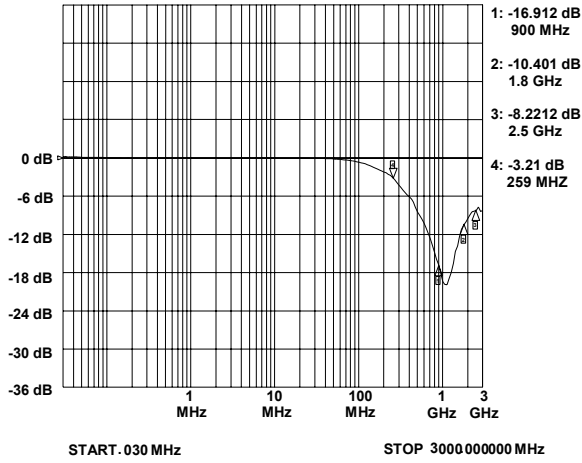

Analog Crosstalk (Each Line)

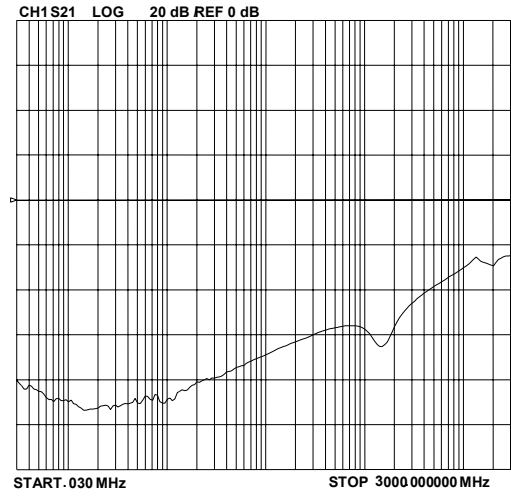

ESD Clamping
(+8kV per IEC 61000-4-2)

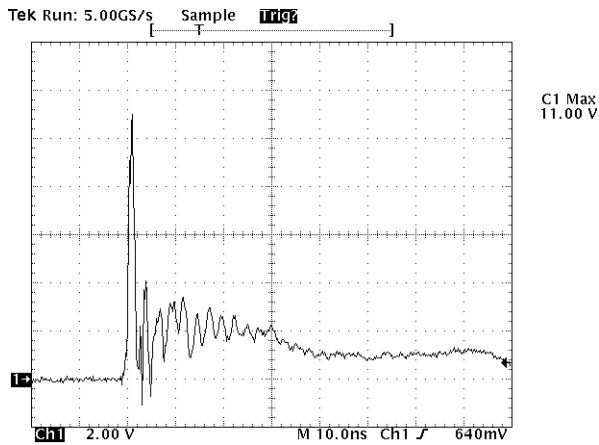

Note: Data is taken with a 10x attenuator

ESD Clamping
(-8kV per IEC 61000-4-2)

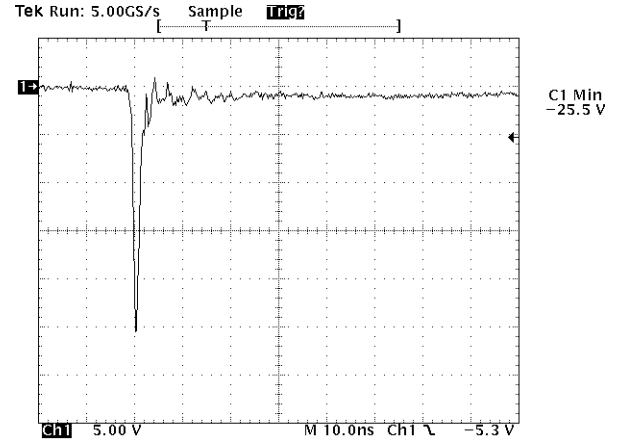

Note: Data is taken with a 10x attenuator

PROTECTION PRODUCTS

Applications Information

Device Connection Options for Protection of Two High-Speed Data Lines

These devices are designed to protect two high-speed data lines (one differential pair) from transient over-voltages which result from lightning and ESD. They can be configured to protect in differential (Line-to-Line) and common (Line-to-Ground) mode. Data line inputs/outputs are connected at pins 1, 2 and 3, and 8, 9 and 10 as shown. For proper operation, pins 1 - 3 must be connected together and pins 8 - 10 must be connected together. Pins 4, 5, 6, and 7 may be left unconnected. For differential operation, the center tab is also left not connected. For common mode operation, the center tab is connected to ground. The ground connection should be made directly to a ground plane on the board for best results. The use of multiple vias is recommended for reduced ground loop inductance.

Short-Haul/Intrabuilding Immunity Requirements for Ethernet-based Systems

The accelerating demand for bandwidth-hungry services such as Voice over IP, Metropolitan Area Networks (MAN), Ethernet over telecommunications backplanes, and broadband to the home are driving the deployment of high-reliability carrier and enterprise class Ethernet-based systems. These systems require the robust protection of external ports from transient voltage events such as lightning, electrostatic discharge, and cable discharge events. Each new generation of Ethernet deployment yields higher-density boards that demand protection solutions that occupy less board space.

The Telcordia Technologies (Bellcore) GR-1089-CORE specification defines a set of requirements for lightning and AC power cross immunity for intrabuilding equipment. The lightning tests are applied as metallic (line-to-line) or longitudinal (line-to-ground) waveforms. The waveforms are defined with a rise time of $2\mu\text{s}$ and a decay time of $10\mu\text{s}$ with a short circuit current of 100A. One surge of positive and one of negative polarity are applied. To pass the test, the equipment must continue to operate after the test. If a $2/10\mu\text{s}$ generator is unavailable, then a $8/20\mu\text{s}$ waveform may be applied with additional series resistance (6Ω metallic, 12Ω longitudinal).

Circuit Diagram

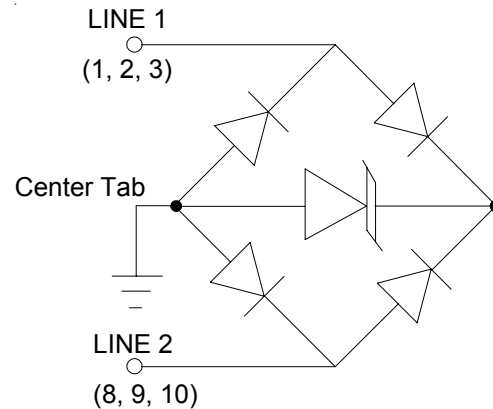

Pin Configuration (Top Side View)

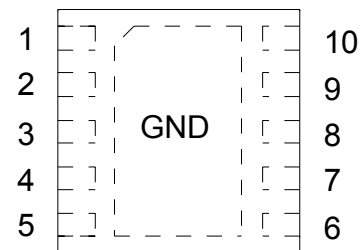

Pin	Identification
1, 2, 3	Line 1 in/out
8, 9, 10	Line 2 in/out
4, 5, 6, 7	No Connect
Center Tab	Ground

PROTECTION PRODUCTS

Typical Applications

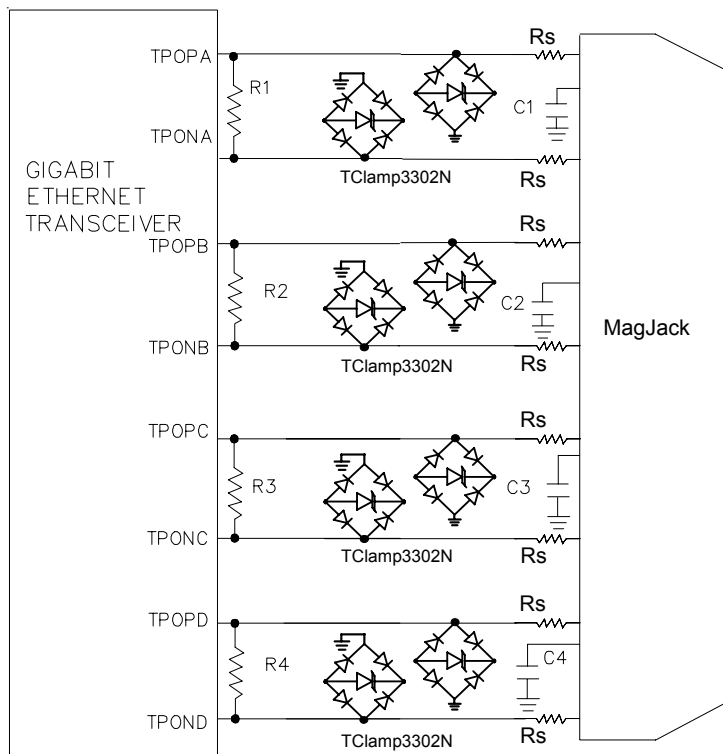

Note: Rs = 2 Ohm, 1% tolerance

Schematic Diagram for Telcordia GR-1089 Intra-Building Protection Gigabit Ethernet with Magjack

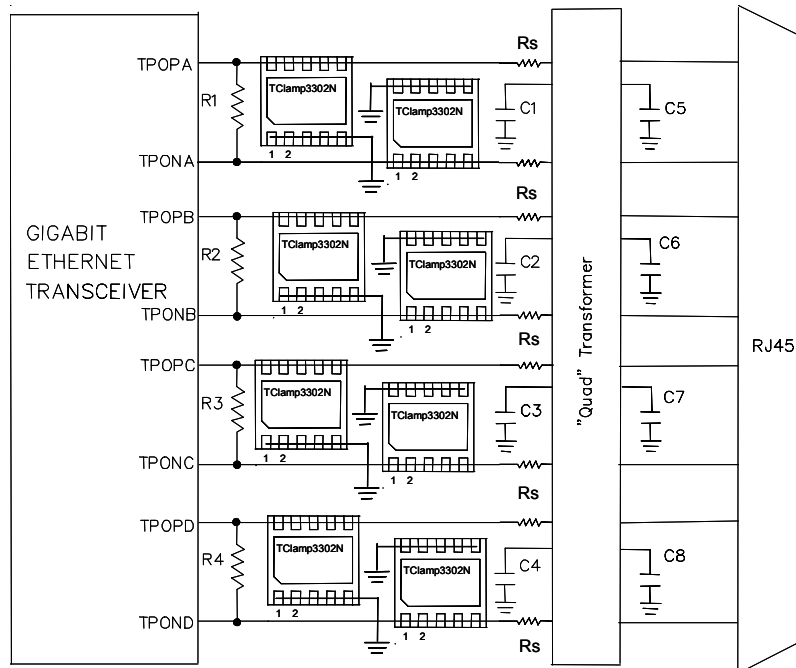

Note: Rs = 2 Ohm, 1% tolerance

Layout Diagram for Telcordia GR-1089 Intra-Building Protection Gigabit Ethernet

PROTECTION PRODUCTS

Applications Information - Spice Model

TClamp3302N Spice Model & Parameters

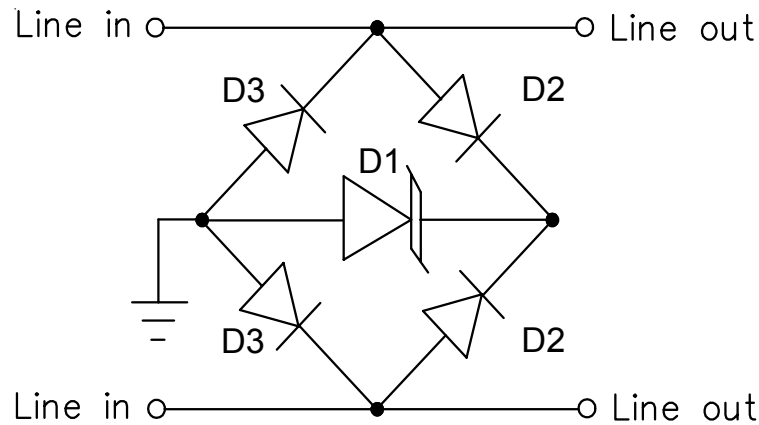

TClamp3302N Spice Model

TClamp3302N Spice Parameters				
Parameter	Unit	D1 (TVS)	D2 (LCRD)	D3 (LCRD)
IS	Amp	1.4E-11	1.001E-20	1.001E-20
BV	Volt	3.3	150	150
VJ	Volt	8	0.59	0.59
RS	Ohm	0.04	0.075	0.05
IBV	Amp	1E-3	1E-3	1E-3
CJO	Farad	400e-12	11.0E-12	11.0E-12
TT	sec	2.541E-9	2.541E-9	2.541E-9
M	--	0.256	0.01	0.01
N	--	1.1	1.1	1.1
EG	eV	1.11	1.11	1.11

PROTECTION PRODUCTS

Outline Drawing - SLP2626P10

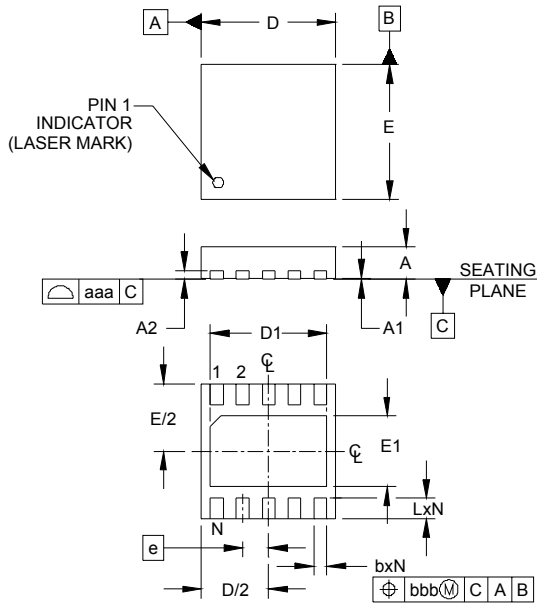

DIM	DIMENSIONS					
	INCHES			MILLIMETERS		
	MIN	NOM	MAX	MIN	NOM	MAX
A	.020	.024	.026	0.50	0.60	0.65
A1	.000	.001	.002	0.00	0.03	0.05
A2	(.007)			(0.17)		
b	.007	.010	.012	0.20	0.25	0.30
D	.098	.102	.106	2.50	2.60	2.70
D1	.079	.085	.089	2.00	2.15	2.25
E	.098	.102	.106	2.50	2.60	2.70
E1	.044	.050	.054	1.11	1.26	1.36
e	.020 BSC			0.50 BSC		
L	.011	.014	.016	0.30	0.35	0.40
N	10			10		
aaa	.003			0.08		
bbb	.004			0.10		

NOTES:

1. CONTROLLING DIMENSIONS ARE IN MILLIMETERS (ANGLES IN DEGREES).
2. COPLANARITY APPLIES TO THE EXPOSED PAD AS WELL AS THE TERMINALS.

Land Pattern - SLP2626P10

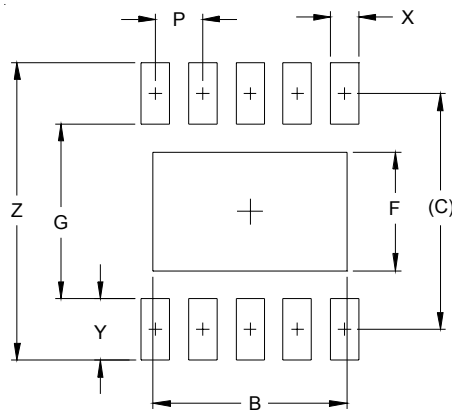

DIM	DIMENSIONS	
	INCHES	MILLIMETERS
B	.081	2.05
C	.100	2.50
F	.050	1.26
G	.073	1.85
P	.020	0.50
X	.012	0.30
Y	.025	0.65
Z	.124	3.15

NOTES:

1. THIS LAND PATTERN IS FOR REFERENCE PURPOSES ONLY. CONSULT YOUR MANUFACTURING GROUP TO ENSURE YOUR COMPANY'S MANUFACTURING GUIDELINES ARE MET.

PROTECTION PRODUCTS

Marking

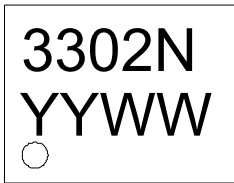

YY = year
WW = Week

Ordering Information

Part Number	Qty per Reel	Reel Size
TClamp3302N.TCT	3,000	7 Inch

Note: Lead finish is lead-free NiPdAu

TransClamp and TClamp are marks of Semtech Corporation

Tape and Reel Specification

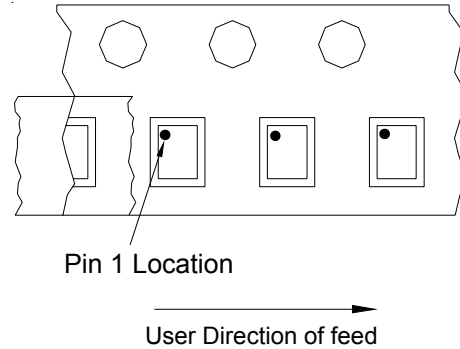
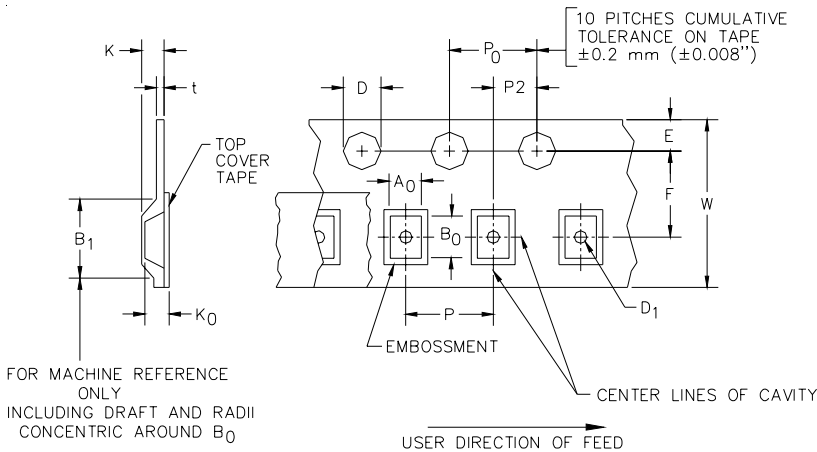

Device Orientation in Tape

A0	B0	K0
2.77 +/-0.10 mm	2.77 +/-0.10 mm	0.80 +/-0.10 mm

Tape Width	B, (Max)	D	D1	E	F	K (MAX)	P	P0	P2	T(MAX)	W
8 mm	4.2 mm (.165)	1.5 + 0.1 mm - 0.0 mm	1.0 mm ±0.05	1.750±.10 mm	3.5±0.05 mm	2.4 mm	4.0±0.1 mm	4.0±0.1 mm	2.0±0.05 mm	0.4 mm	8.0 mm + 0.3 mm - 0.1 mm

Contact Information

Semtech Corporation
Protection Products Division
200 Flynn Rd., Camarillo, CA 93012
Phone: (805)498-2111 FAX (805)498-3804

Mouser Electronics

Authorized Distributor

Click to View Pricing, Inventory, Delivery & Lifecycle Information:

[Semtech:](#)

[TCLAMP3302N.TCT](#) [TCLAMP1201S.TCT](#)