

General Purpose AC/DC EMI Filter

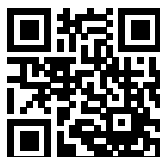

Images are for reference only. Please see product specifications

- Rated currents from 1 to 60 A
- General purpose filtering performance
- Optional medical versions (B type)
- Optional safety versions (A type)
- Optional enhanced performance versions
- Optional DC optimized versions



Performance indicators

Attenuation performance



Rated current [A]



Approvals & Compliances



Features and Benefits

- FN 2010 filters are designed for easy and fast chassis mounting
- FN 2010 B versions without capacitors to earth comply to 1MOP for ME (medical equipment) acc. IEC 60601-1
- FN 2010 A versions with low capacitance to earth for safety critical applications with necessity for low leakage currents
- FN 2010 filters are also available as enhanced performance and DC optimized versions. With higher attenuation in very compact housing (M, N1,N types)
- All filters provide a general purpose conducted attenuation performance, based on chokes with high saturation resistance and excellent thermal behavior
- FN 2010 filters can be used to cover a broad range of usage and they offer a good size/amperage ratio
- Various terminal options allow you to select the desired connection style

Technical Specifications

Rated voltage*	250 VAC, 50/60 Hz 250 VDC
Operating frequency	DC to 400 Hz
Flammability corresponding to	Laces for -07 version: UL 94 VW-1 Terminal plastic for -06/-08 version: UL 94 V-0 Grommet for -07 version: UL 94 V-0
Overvoltage category	II acc. IEC 60664-1
Pollution degree	2 acc. IEC 60664-1
Altitude	2000m (above derating applies)**
Rated currents	1 to 60 A @ 40°C max.
High potential test voltage	P -> N 1100 VDC for 2 sec P -> PE 2000 VAC for 2 sec (equiv. cap <88 nF) P -> PE 2550 VDC for 2 sec (equiv. cap >88 nF) P -> PE 2500 VAC for 2 sec (B types)
Temperature range (operation and storage)	-25 °C to +100 °C (25/100/21)**
Certified to	UL 1283, CSA 22.2 No. 8 1986, IEC/EN 60939 (applies to AC and DC applications)

* maximum RMS operating voltage at rated frequency or the maximum DC operating voltage
 ** for dedicated requests exceeding this specification (e.g. -40 °C or higher altitude) please contact your local Schaffner sales office



Typical Applications

- Electrical and electronic equipment
- Consumer goods
- Household equipment
- Medical equipment
- Office automation equipment
- Datacom equipment

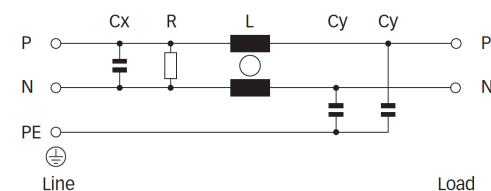
Typical electrical schematic



Filter Selection Table

Filter*	Buy	Rated current @ 40°C (25°C)	Leakage current** @ 250 VAC/50 Hz (@ 120 VAC/60 Hz)	Power loss @25°C/DC	Inductance*** L	Capacitance***		Resistance*** R	Input/Output connections			Weight [g]
						Cx	Cy		-06	-07	-08	
		[A]	[mA]	[W]	[mH]	[μF]	[nF]	[kΩ]				
FN2010-1-..		1 (1.15)	0.66 (0.38)	0.8	12	0.1	4.7	1000	-06	-07		65
FN2010-3-..		3 (3.45)	0.66 (0.38)	1.1	2.5	0.1	4.7	1000	-06	-07		65
FN2010-6-..		6 (6.9)	0.66 (0.38)	1.7	1	0.1	4.7	1000	-06	-07		65
FN2010-10-..		10 (11.5)	0.66 (0.38)	2.5	0.8	0.1	4.7	1000	-06	-07		85
FN2010-12-..		12 (13.8)	0.66 (0.38)	3.6	0.7	0.1	4.7	1000	-06	-07		85
FN2010-16-..		16 (18.4)	0.66 (0.38)	2.5	0.7	0.1	4.7	1000	-06	-07	-08	140
FN2010-20-..		20 (23)	0.66 (0.38)	3.8	0.6	0.1	4.7	1000	-06	-07	-08	210
FN2010-30-08		30 (34.5)	0.79 (0.46)	6.3	0.7	0.47	10	1000			-08	470
FN2010-60-24		60 (69)	0.79 (0.46)	14.7	1	1.5	10	330			-24	1100
FN2010A-1-..		1 (1.15)	0.07 (0.04)	0.8	12	0.1	0.47	1000	-06	-07		65
FN2010A-3-..		3 (3.45)	0.07 (0.04)	1.1	2.5	0.1	0.47	1000	-06	-07		65
FN2010A-6-..		6 (6.9)	0.07 (0.04)	1.7	1	0.1	0.47	1000	-06	-07		65
FN2010A-10-..		10 (11.5)	0.07 (0.04)	2.5	0.8	0.1	0.47	1000	-06	-07		85
FN2010A-12-..		12 (13.8)	0.07 (0.04)	3.6	0.7	0.1	0.47	1000	-06	-07		85
FN2010A-16-..		16 (18.4)	0.07 (0.04)	2.5	0.7	0.1	0.47	1000	-06	-07	-08	140
FN2010A-20-..		20 (23)	0.07 (0.04)	3.8	0.6	0.1	0.47	1000	-06	-07	-08	210
FN2010A-30-08		30 (34.5)	0.07 (0.04)	6.3	0.7	0.47	0.47	1000			-08	470
FN2010A-60-24		60 (69)	0.07 (0.04)	14.7	1	1.5	0.47	330			-24	1100
FN2010B-1-..		1 (1.15)	0.00	0.8	12	0.1		1000	-06	-07		65
FN2010B-3-..		3 (3.45)	0.00	1.1	2.5	0.1		1000	-06	-07		65
FN2010B-6-..		6 (6.9)	0.00	1.7	1	0.1		1000	-06	-07		65
FN2010B-10-..		10 (11.5)	0.00	2.5	0.8	0.1		1000	-06	-07		85
FN2010B-12-..		12 (13.8)	0.00	3.6	0.7	0.1		1000	-06	-07		85
FN2010B-16-..		16 (18.4)	0.00	2.5	0.7	0.1		1000	-06	-07	-08	140
FN2010B-20-..		20 (23)	0.00	3.8	0.6	0.1		1000	-06	-07	-08	210
FN2010B-30-08		30 (34.5)	0.00	6.3	0.7	0.47		1000			-08	470
FN2010B-60-24		60 (69)	0.00	14.7	1	1.5		330			-24	1100
Enhanced performance												
FN2010N1-1-06		1 (1.15)	5.34 (3.08)	0.8	12	0.1	68	1000	-06			70
FN2010N1-3-06		3 (3.45)	5.34 (3.08)	1.1	2.5	0.1	68	1000	-06			70
FN2010N1-6-06		6 (6.9)	5.34 (3.08)	1.7	1	0.1	68	1000	-06			70
FN2010N1-10-06		10 (11.5)	5.34 (3.08)	2.5	0.8	0.1	68	1000	-06			85
FN2010N1-12-06		12 (13.8)	3.69 (2.13)	3.6	0.7	0.1	47	1000	-06			85
FN2010M-16-..		16 (18.4)	3.69 (2.13)	2.5	0.7	0.1	47	1000	-06		-08	140
FN2010M-20-..		20 (23)	3.69 (2.13)	3.8	0.6	0.1	47	1000	-06		-08	220
FN2010N-30-08		30 (34.5)	7.85 (4.52)	6.3	0.7	0.47	100	1000			-08	400
FN2010N-60-24		60 (69)	7.85 (4.52)	14.7	1	1.5	100	330			-24	1120

*** To compile a complete part number, please replace the -.. with the required I/O connection style (e.g. FN 2010-30-08, FN 2010B-10-06). The different letters code the used Cy values in the filter type (A = 0.47nF; M = 47nF; N1 = 47nF; N = 100nF)

*** Maximum leakage under usual AC operating conditions (acc. IEC 60939-3). Note: if the neutral line is interrupted, worst case leakage could reach twice this level.

*** Tolerances apply: Inductance: -30/+50%, Capacitance: ±20%, Resistance: ±10%

Typical Filter Attenuation

Per CISPR 17: symmetrical 50 Ω/50 Ω -> Differential Mode (DM); asymmetrical 50 Ω/50 Ω -> Common Mode (CM)

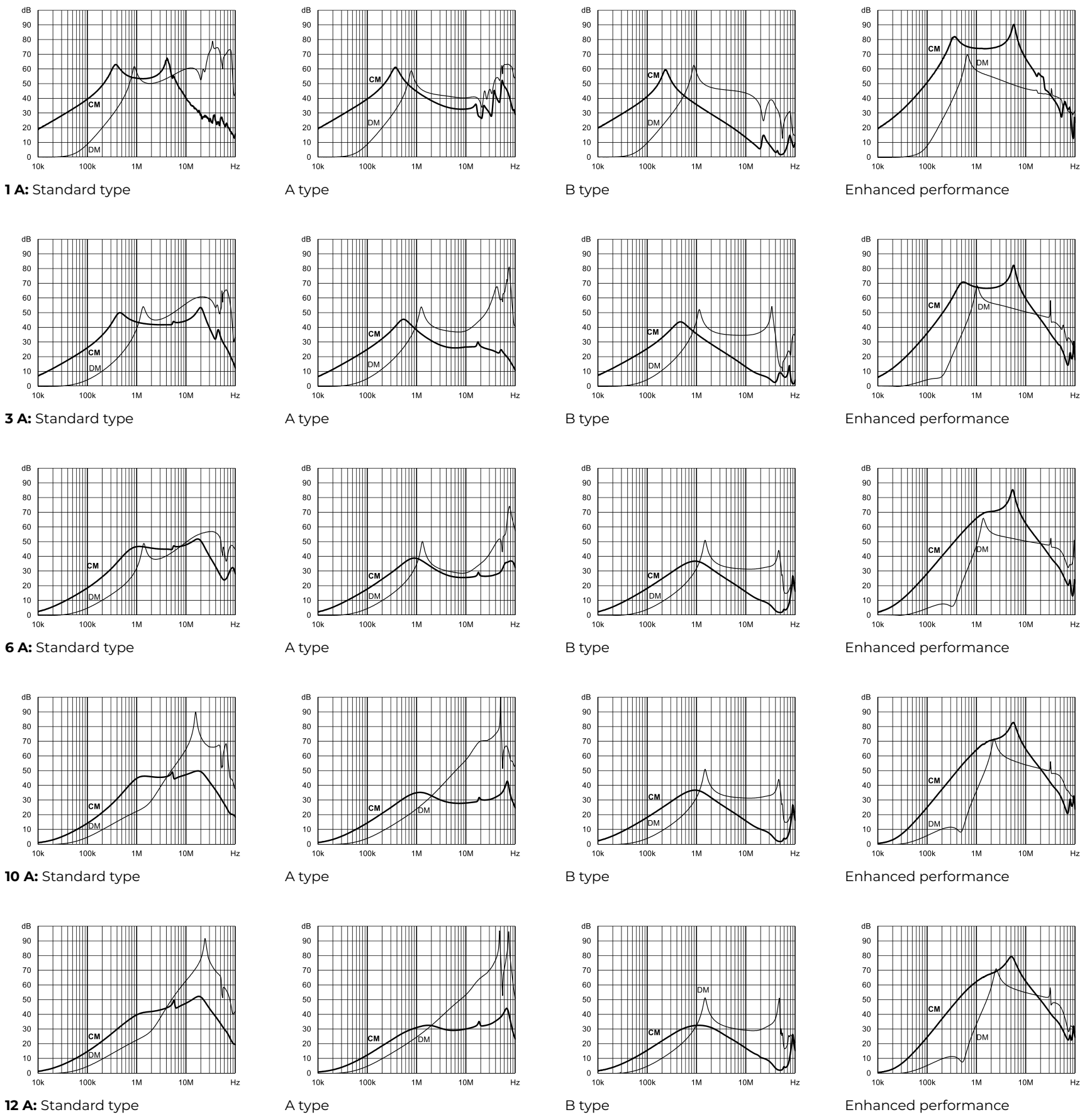

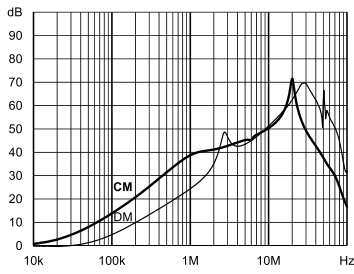

16 A: Standard type

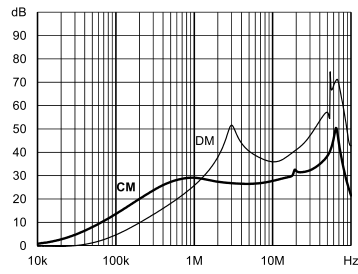

A type

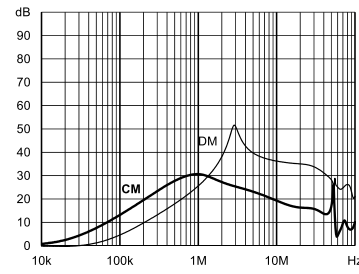

B type

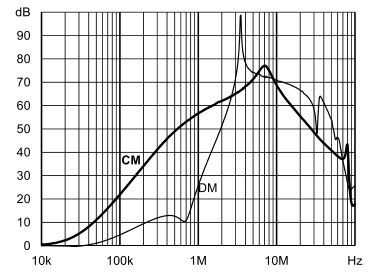

Enhanced performance

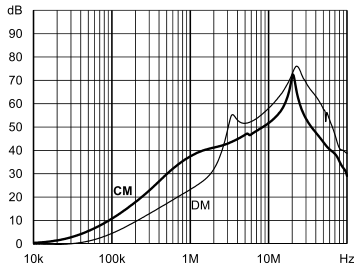

20 A: Standard type

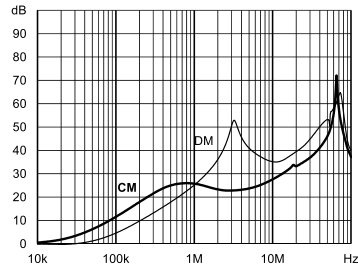

A type

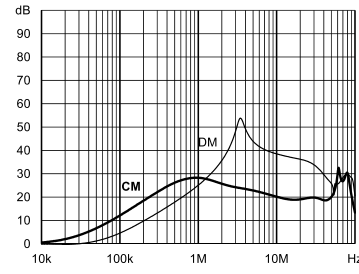

B type

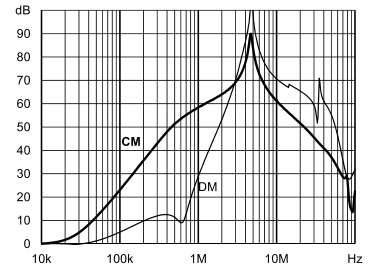

Enhanced performance

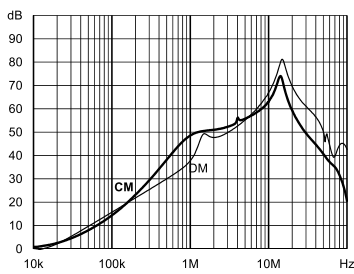

30 A: Standard type

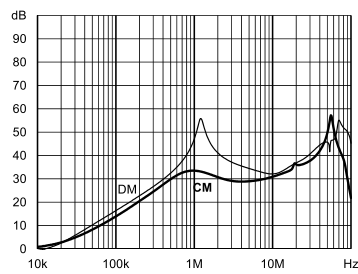

A type

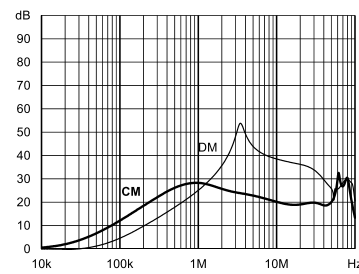

B type

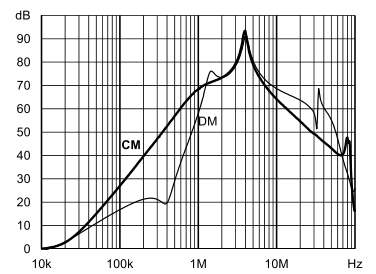

Enhanced performance

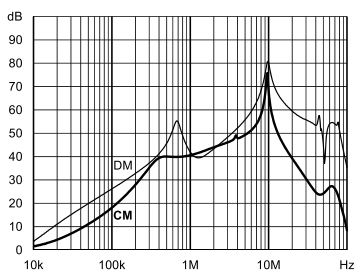

60 A: Standard type

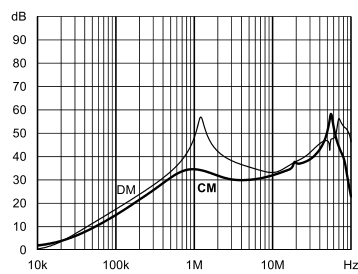

A type

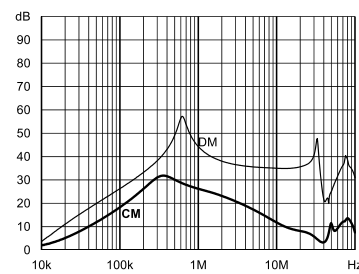

B type

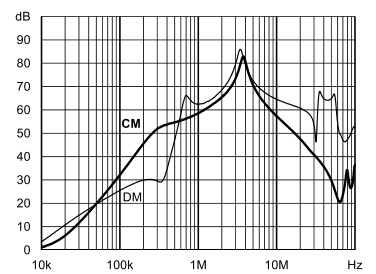

Enhanced performance

Product Selector		
FN 2010-xy-xx-yy		
06		Faston 6.3 × 0.8 mm (spade/soldering)
07		Wire leads
08		Studs (M4 screws)
24		Studs (M6 screws)
1 to 60		Rated current
Blank		Standard version
Z		With surge protection
Blank		Standard version
A		Safety version
B		Medical version
N1/N/M		High performance version

Mechanical Data

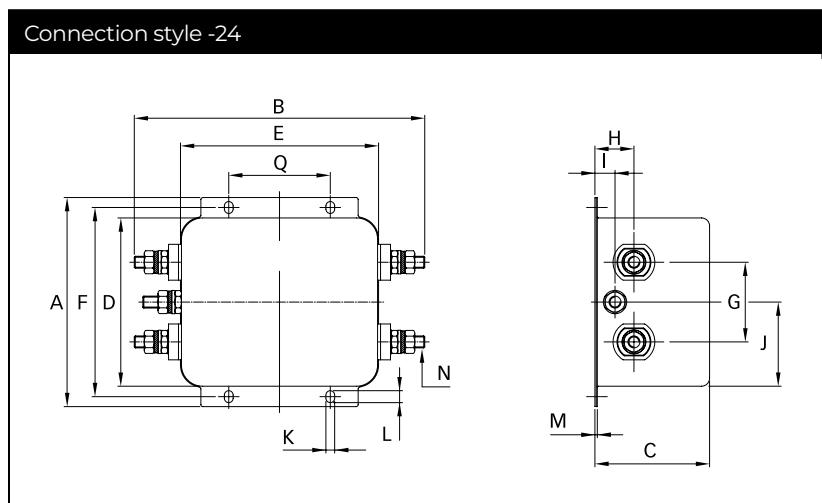
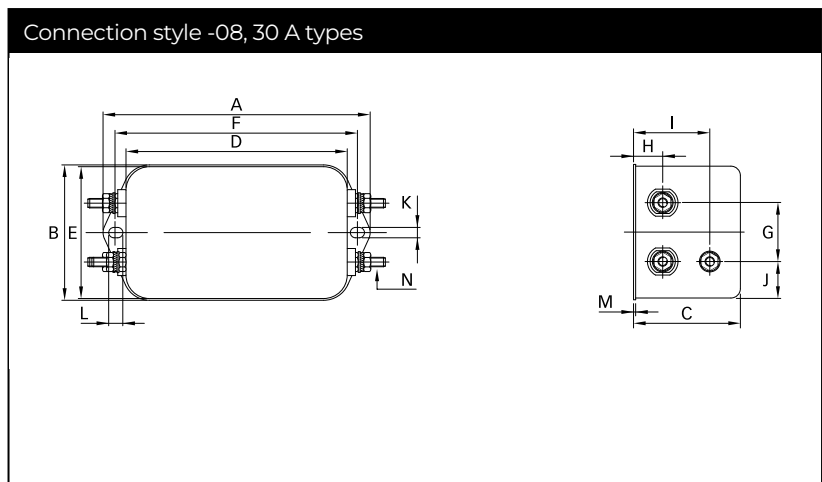
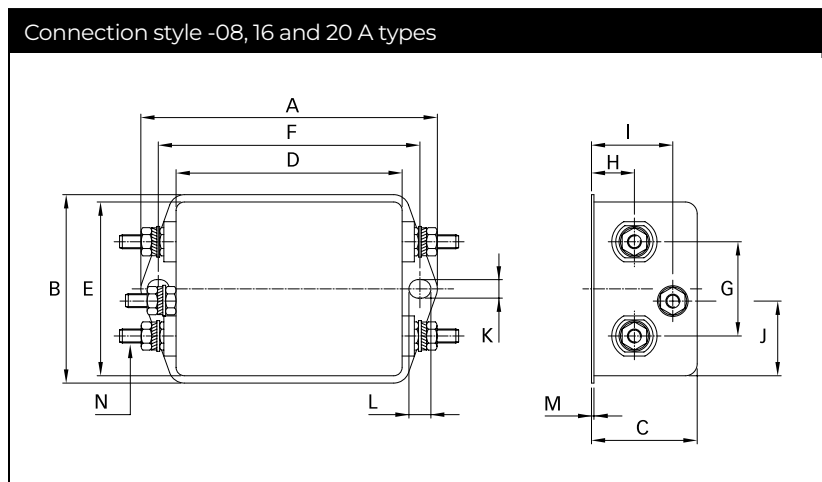
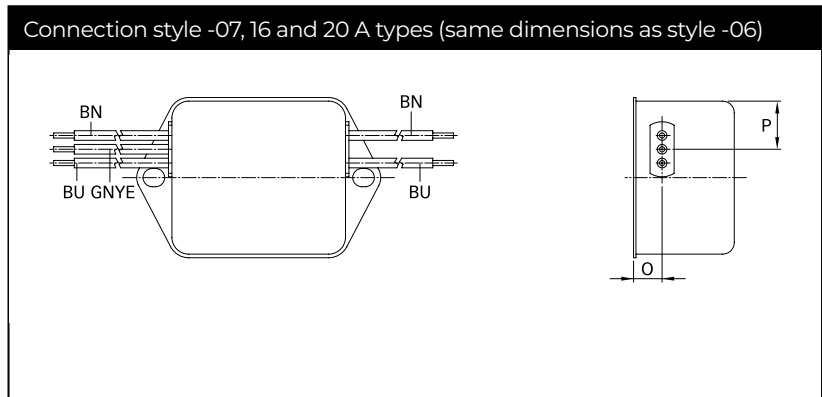
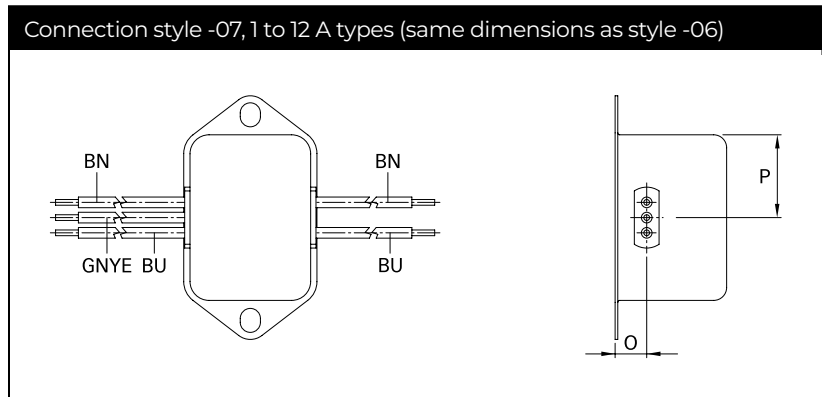
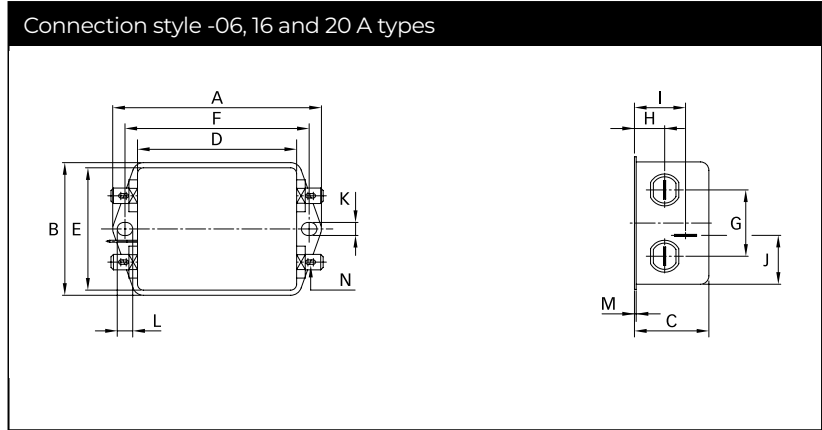
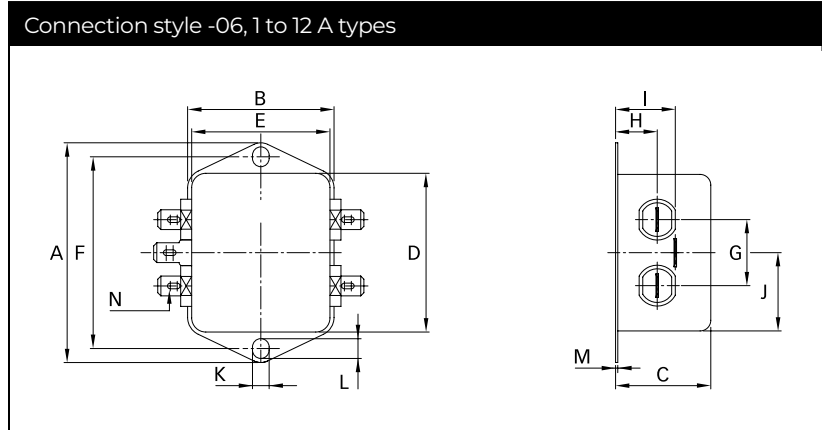

Dimensions

	1 A	3 A	6 A	10 A	12 A	16 A	20 A	30 A	60 A	Tolerances
A	64	64	64	64	64	71	85	113.5 ±1	105 ±1	±0.5
B	35	35	35	35	35	46.6	54	57.5 ±1	145.9 ±1	±0.5
C	24.3	24.3	24.3	29.3	29.3	29.3	30.3	45.4 ±1	57.6 ±1	±0.5
D	43.5	43.5	43.5	43.5	43.5	50.5	64.8	94 ±1	84.5 ±1	±0.5
E	32.5	32.5	32.5	32.5	32.5	44.5	49.8	56	99.5	±0.5
F	54	54	54	54	54	61	75	103	95	±0.3
G	21	21	21	21	21	21	27	25	40	±0.2
H	9.3	9.3	9.3	9.3	9.3	10.8	12.3	12.4	19.6	±0.5
I	15.3	15.3	15.3	15.3	15.3	19.3	20.8	32.4	10.1	±0.5
J	21.8	21.8	21.8	21.8	21.8	20.1	19.9	15.5	42.25	±0.5
K	5.3	5.3	5.3	5.3	5.3	5.3	5.3	4.4	4.4	
L	6.3	6.3	6.3	6.3	6.3	6.3	6.3	6	6	
M	0.7	0.7	0.7	0.7	0.7	0.7	0.7	1	1.2	±0.3
Connection style -06										
N	6.3 x 0.8	6.3 x 0.8	6.3 x 0.8	6.3 x 0.8	6.3 x 0.8	6.3 x 0.8	6.3 x 0.8			
Connection style -07										
O	8.3	8.3	8.3	8.3	8.3	8.3	8.3			±0.5
P	21.8	21.8	21.8	21.8	21.8	14	14.9			±0.5
AWG type wire	AWG 20	AWG 20	AWG 18	AWG 18	AWG 16	AWG 16	AWG 14			
Wire length	140	140	140	140	140	140	140			+5
Connection style -08										
N						M4	M4	M4		
Recommended torque (Nm)						1.2 - 1.3	1.2 - 1.3	1.2 - 1.3		
Earth terminal						1.5 - 1.7	1.5 - 1.7	1.5 - 1.7		
Connection style -24										
N									M6	
Q									51	±0.2
Recommended torque (Nm)									3.5 - 4	
Earth Terminal									3.5 - 4	

All dimensions in mm; 1 inch = 25.4 mm

Tolerances according: ISO 2768-m/EN 22768-m

Please visit www.schaffner.com to find more details on filter connections.

Headquarters, Global Innovation and Development

Switzerland

Schaffner Group

Industrie Nord
Nordstrasse 11e
4542
Luterbach
+41 32 681 66 26
info@schaffner.com

Sales and Application Centers

Finland

Schaffner Oy

Sauvonrinne 19 H
8500
Lohja
+358 50 468 7284
finlandsales@schaffner.com

France

Schaffner EMC S.A.S.

16-20 Rue Louis Rameau
95875
Bezons
+33 1 34 34 30 60
francesales@schaffner.com

Germany

Schaffner Deutschland GmbH

Schoemperlenstrasse 12B
76185
Karlsruhe
+49 721 56910
germanysales@schaffner.com

India

Schaffner India Pvt. Ltd

Regus World Trade Centre
WTC 22nd Floor Unit No 2238 Brigade
Gateway Campus 26/1 Dr. Rajkumar Road
Malleshwaram (W)
560055
Bangalore
+91 8067935355
indiasales@schaffner.com

United Kingdom

Schaffner Ltd.

Suite 1 Oakmede Place
Terrace Road
RG42 4JF
Binfield
+44 118 9770070
uksales@schaffner.com

United States

Schaffner EMC Inc.

52 Mayfield Avenue
Edison, New Jersey
+1 732 225 9533
usasales@schaffner.com

Sweden

Schaffner EMC AB

Östermalmstrorg 1
114 42
Stockholm
+46 8 5050 2425
swedensales@schaffner.com

Switzerland

Schaffner EMV AG

Industrie Nord
Nordstrasse 11e
4542
Luterbach
+41 32 681 66 26
switzerlandsales@schaffner.com

Taiwan

Schaffner EMV Ltd.

U-Town
20 Floor-2 No 97 Section 1 XinTai 5th Road
XiZhi District
22175
New Taipei City
+886 226975500
taiwansales@schaffner.com

Italy

Schaffner EMC S.r.l.

Via Ticino, 30
20900
Monza (MB)
+39 039 21 41 070
italysales@schaffner.com

Japan

Schaffner EMC K.K.

ISM Sangenjaya
7F 1-32-12 Kamiyuma Setagaya-ku
154-0011
Tokyo
+81 3 5712 3650
japansales@schaffner.com

Singapore

Schaffner EMC Pte Ltd.

Blk 3015A Ubi Road 1 #05-09 Kampong Ubi
Industrial Estate
408705
Singapore
+65 63773283
singaporesales@schaffner.com

To find your local partner within Schaffner's global network schaffner.com

© 2023 Schaffner Group

The content of this document has been carefully checked and understood. However, neither Schaffner nor its subsidiaries assume any liability whatsoever for any errors or inaccuracies of this document and the consequences thereof. Published specifications are subject to change without notice. Product suitability for any area of application must ultimately be determined by the customer. In all cases, products must never be operated outside their published specifications. Schaffner does not guarantee the availability of all published products. This disclaimer shall be governed by substantive Swiss law and resulting disputes shall be settled by the courts at the place of business of Schaffner Holding AG. Latest publications and a complete disclaimer can be downloaded from the Schaffner website. All trademarks recognized.

Mouser Electronics

Authorized Distributor

Click to View Pricing, Inventory, Delivery & Lifecycle Information:

Schaffner:

[FN2010-20-06](#) [FN2010-16-06](#) [FN2010-6-06](#) [FN2010-30-08](#) [FN2010A-20-06](#) [FN2010B-3-06](#) [FN2010B-6-06](#)
[FN2010-60-24](#) [FN2010-12-06](#) [FN2010-10-07](#) [FN2010-3-07](#) [FN2010-20-08](#) [FN2010-1-07](#) [FN2010-3-06](#) [FN2010-16-07](#) [FN2010-1-06](#) [FN2010-6-07](#) [FN2010-20-07](#) [FN2010-10-06](#) [FN2010-12-07](#) [FN2010-30-17](#) [FN2010A-3-06](#)
[FN2010A-6-06](#) [FN2010A-6-07](#) [FN2010A-20-08](#) [FN2010A-30-08](#) [FN2010B-1-06](#) [FN2010B-3-07](#) [FN2010B-6-07](#)
[FN2010B-10-06](#) [FN2010B-16-06](#) [FN2010B-20-06](#) [FN2010B-20-08](#) [FN2010B-30-08](#) [FN2010A-16-06](#) [FN2010N1-3-06](#)
[FN2010N1-12-06](#) [FN2010M-16-06](#) [FN2010N1-6-06](#) [FN2010N-30-08](#) [FN2010M-20-06](#) [FN2010N1-1-06](#) [FN2010N1-10-06](#) [FN2010M-20-08](#) [FN2010N-60-24](#) [FN2010A-10-06](#) [FN2010A-12-06](#) [FN2010A-10-07](#) [FN2010A-3-07](#)
[FN2010B-60-24](#) [FN2010M-16-08](#) [FN2010-16-08](#) [FN2010A-1-06](#)