

SFH 2700 FA

CHIPLED®

Silicon PIN Photodiode

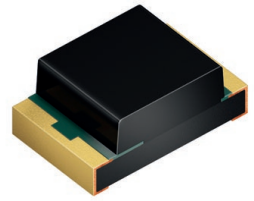

Applications

- Industrial Automation (Machine controls, Light barriers, Vision controls)

Features:

- Package: black epoxy
- ESD: 2 kV acc. to ANSI/ESDA/JEDEC JS-001 (HBM, Class 2)
- Very small SMT package
- Especially suitable for applications from 700 nm to 1100 nm

Ordering Information

Type	Photocurrent $E_e = 0.5 \text{ mW/cm}^2; \lambda = 850 \text{ nm}; V_R = 5 \text{ V}$ I_P	Photocurrent typ. $E_e = 0.5 \text{ mW/cm}^2; \lambda = 850 \text{ nm}; V_R = 5 \text{ V}$ I_P	Ordering Code
SFH 2700 FA	$\geq 1.2 \mu\text{A}$	1.5 μA	Q65112A4434

Maximum Ratings

Parameter	Symbol		Values
Operating Temperature	T_{op}	min.	-40 °C
		max.	100 °C
Storage temperature	T_{stg}	min.	-40 °C
		max.	100 °C
Reverse voltage	V_R	max.	16 V
ESD withstand voltage acc. to ANSI/ESDA/JEDEC JS-001 (HBM, Class 2)	V_{ESD}	max.	2 kV

Characteristics

$T_A = 25\text{ °C}$

Parameter	Symbol		Values
Wavelength of max sensitivity	$\lambda_{S\ max}$	typ.	890 nm
Spectral range of sensitivity	$\lambda_{10\%}$	typ.	700 ... 1100 nm
Radiant sensitive area	A	typ.	0.35 mm ²
Dimensions of active chip area	L x W	typ.	0.59 x 0.59 mm x mm
Half angle	φ	typ.	60 °
Dark current	I_R	typ.	0.045 nA
$V_R = 5\text{ V}$		max.	5 nA
Open-circuit voltage	V_O	min.	290 mV
$E_e = 0.5\text{ mW/cm}^2$; $\lambda = 850\text{ nm}$		typ.	300 mV
Short-circuit current	I_{SC}	typ.	1.4 μ A
$E_e = 0.5\text{ mW/cm}^2$; $\lambda = 850\text{ nm}$			
Rise time	t_r	typ.	0.12 μ s
$V_R = 5\text{ V}$; $R_L = 50\ \Omega$; $\lambda = 850\text{ nm}$			
Fall time	t_f	typ.	0.12 μ s
$V_R = 5\text{ V}$; $R_L = 50\ \Omega$; $\lambda = 850\text{ nm}$			
Forward voltage	V_F	typ.	0.8 V
$I_F = 5\text{ mA}$			
Capacitance	C_0	typ.	4.6 pF
$V_R = 0\text{ V}$; $f = 1\text{ MHz}$; $E = 0$			

Relative Spectral Sensitivity ^{1), 2)}

$$S_{rel} = f(\lambda)$$

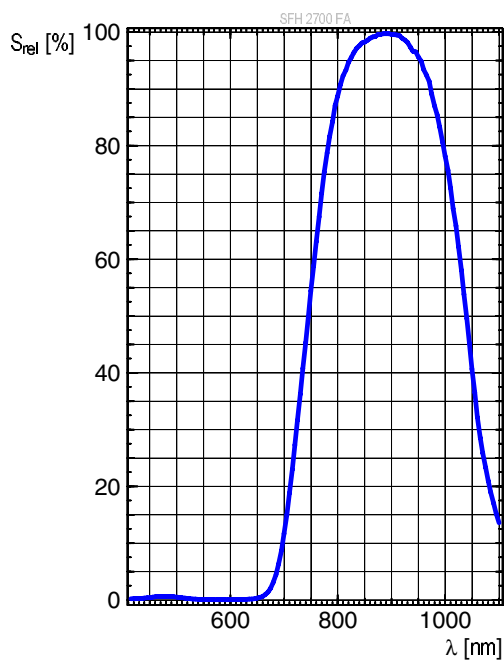

Directional Characteristics ^{1), 2)}

$$S_{rel} = f(\varphi)$$

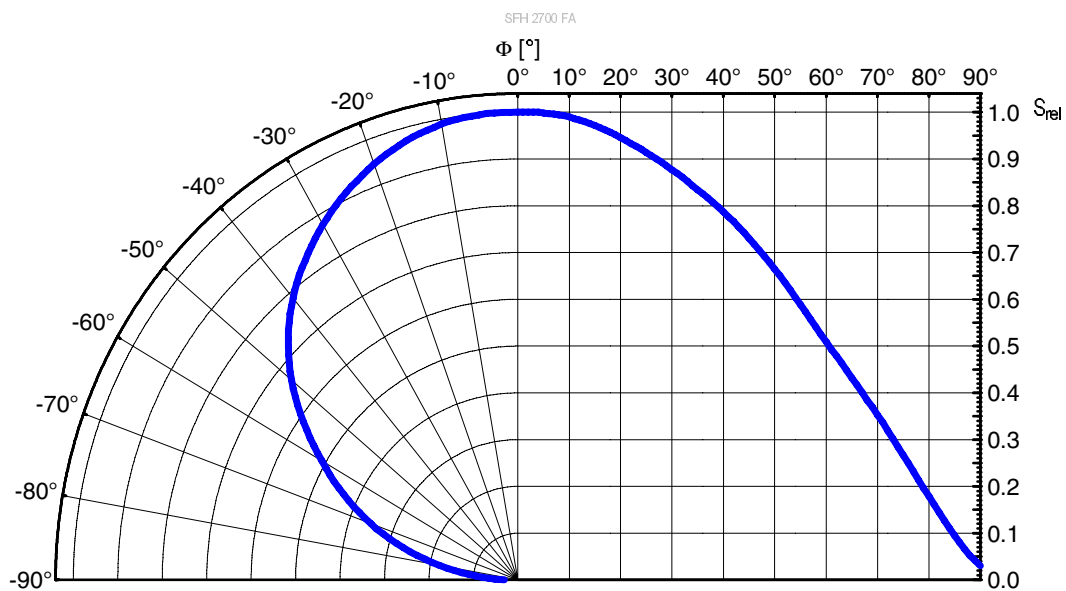

Photocurrent 1), 2)

$I_p = f(E_e); \lambda = 850 \text{ nm}; V_R = 5 \text{ V}$

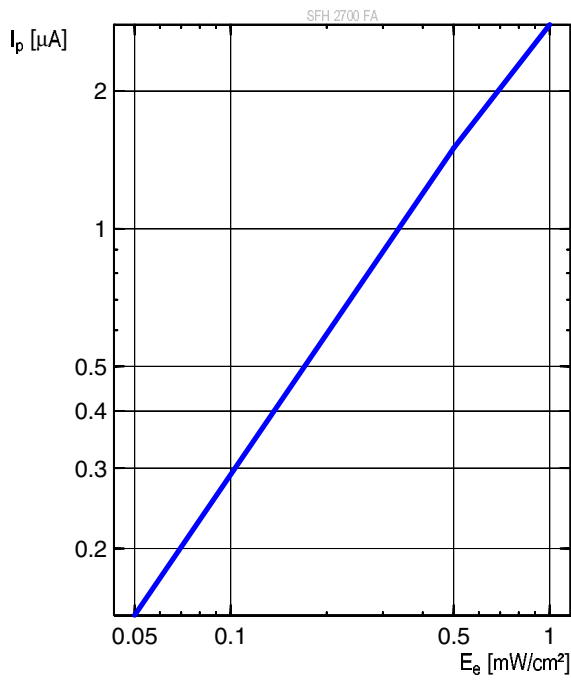

Dark Current 1), 2)

$I_R = f(V_R); E = 0$

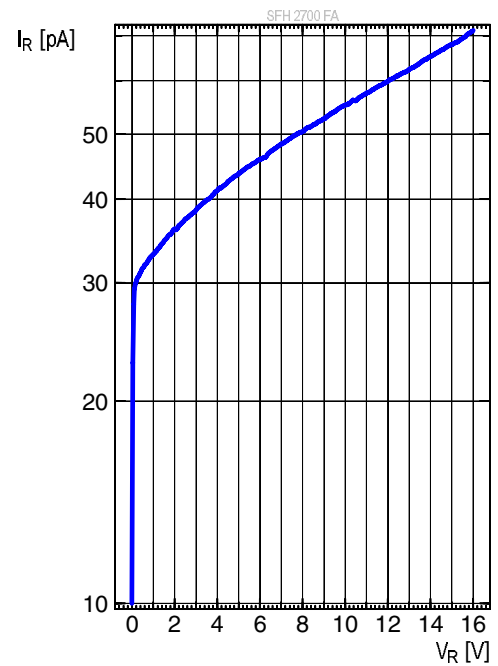

Capacitance 1), 2)

$C = f(V_R); f = 1 \text{ MHz}; E = 0;$

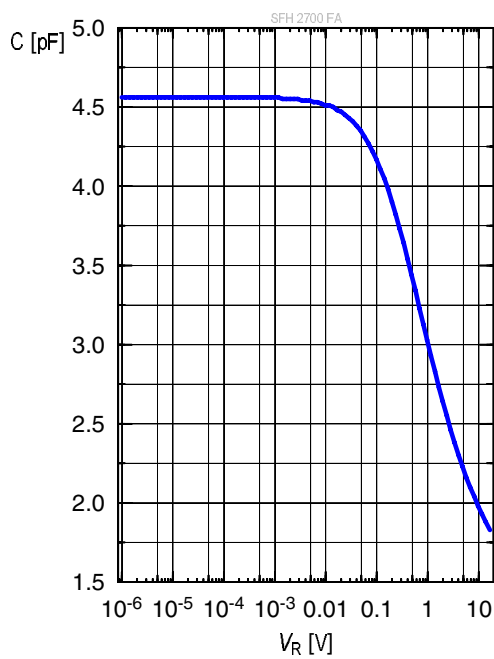

Dimensional Drawing ³⁾

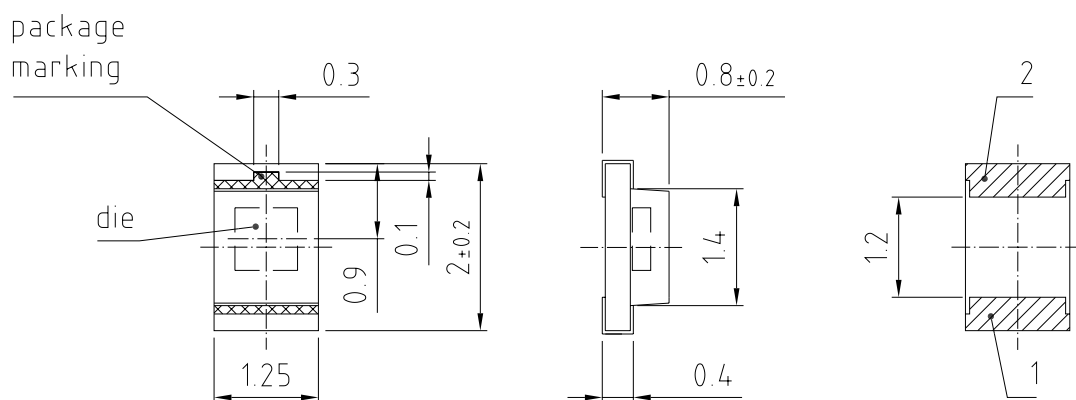

general tolerance ± 0.1
 lead finish Au

C67062-A0256-A1..-02

Approximate Weight: 3.8 mg
Package marking: Cathode

Pin	Description
1	Anode
2	Cathode

Recommended Solder Pad ³⁾

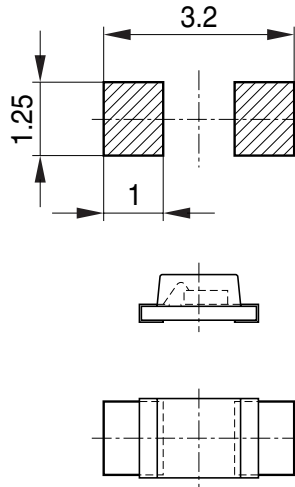

Bauteil positioniert
Component location on pad

OHFP2578

Reflow Soldering Profile

Product complies to MSL Level 3 acc. to JEDEC J-STD-020E

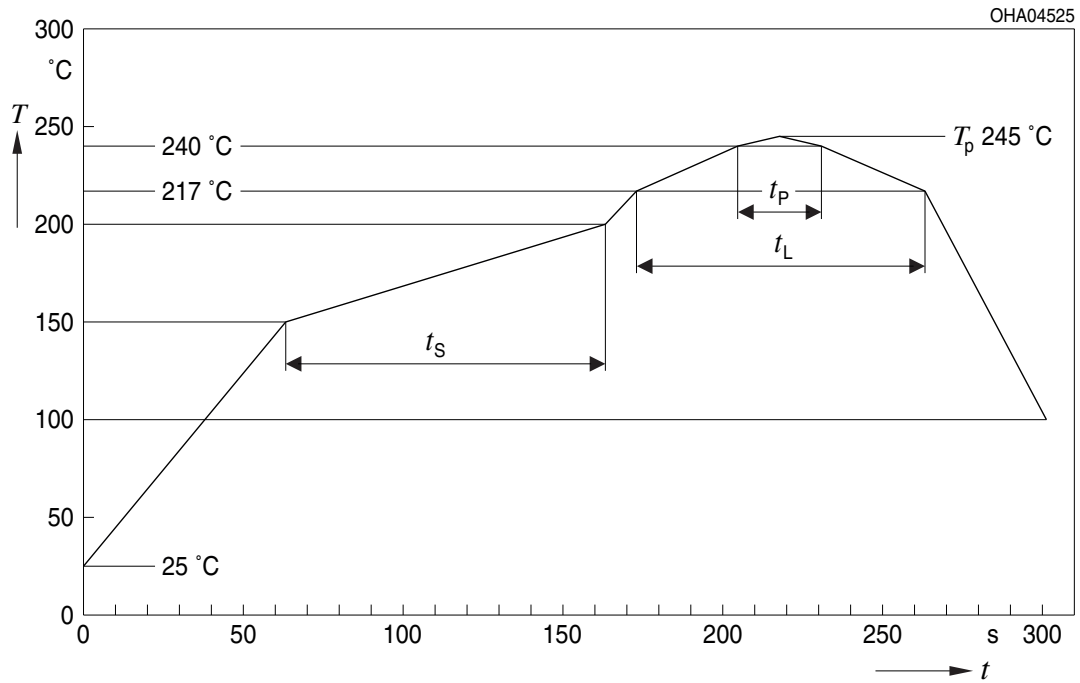

Profile Feature	Symbol	Pb-Free (SnAgCu) Assembly			Unit
		Minimum	Recommendation	Maximum	
Ramp-up rate to preheat ^{*)} 25 °C to 150 °C			2	3	K/s
Time t_s T_{Smin} to T_{Smax}	t_s	60	100	120	s
Ramp-up rate to peak ^{*)} T_{Smax} to T_p			2	3	K/s
Liquidus temperature	T_L		217		°C
Time above liquidus temperature	t_L		80	100	s
Peak temperature	T_p		245	260	°C
Time within 5 °C of the specified peak temperature $T_p - 5$ K	t_p	10	20	30	s
Ramp-down rate* T_p to 100 °C			3	6	K/s
Time 25 °C to T_p				480	s

All temperatures refer to the center of the package, measured on the top of the component

* slope calculation DT/Dt : Dt max. 5 s; fulfillment for the whole T-range

Taping ³⁾

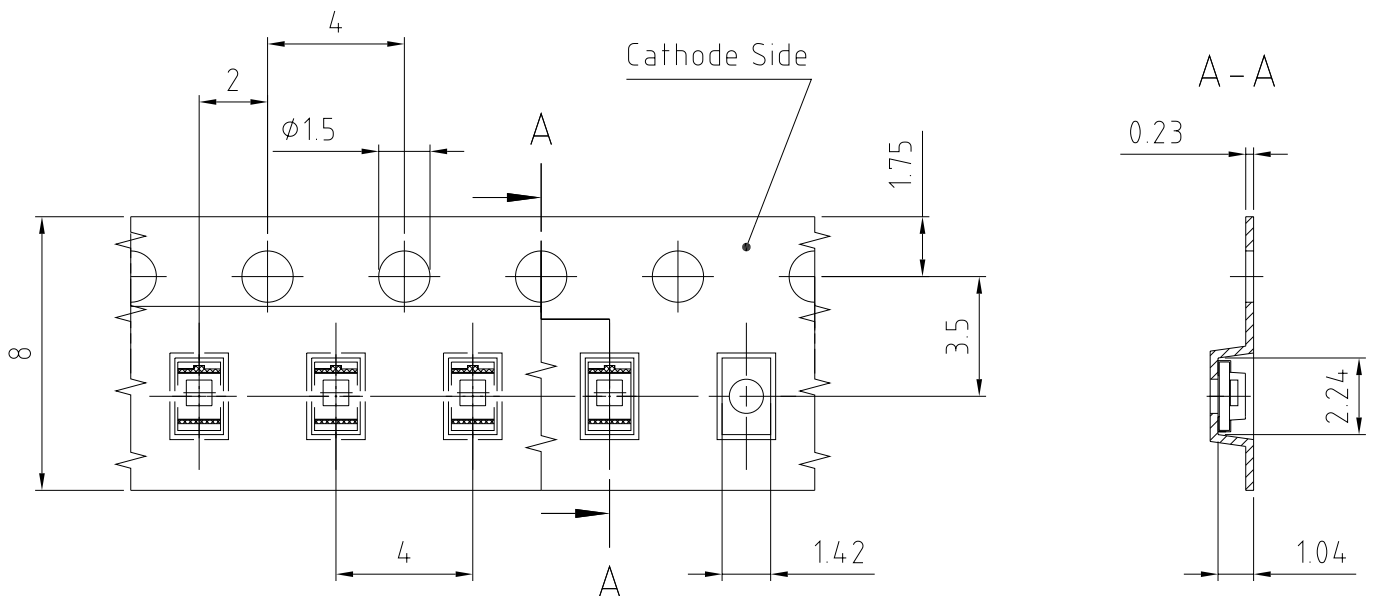

C67062-A0256-B1-02

Tape and Reel ⁴⁾

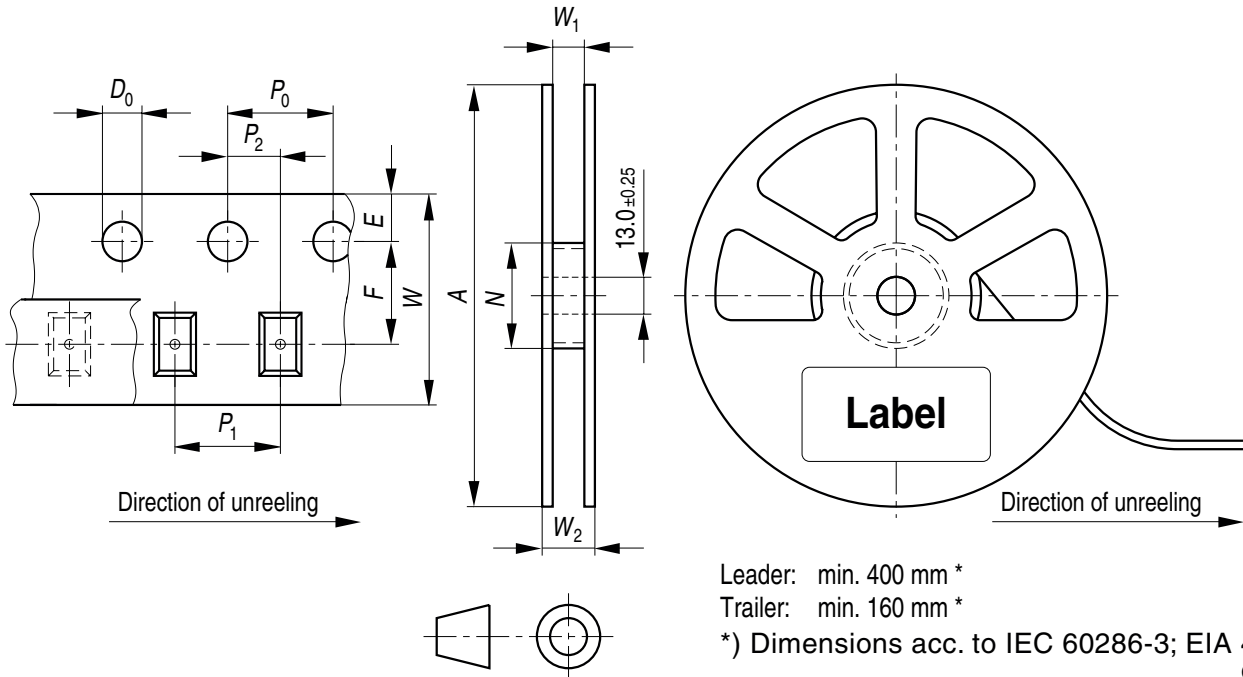

Reel dimensions [mm]

A	W	N _{min}	W ₁	W _{2 max}	Pieces per PU
180 mm	8 + 0.3 / - 0.1	60	8.4 + 2	14.4	3000

Barcode-Product-Label (BPL)

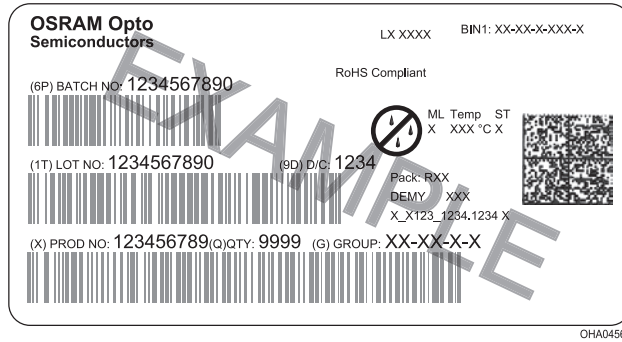

Dry Packing Process and Materials ³⁾

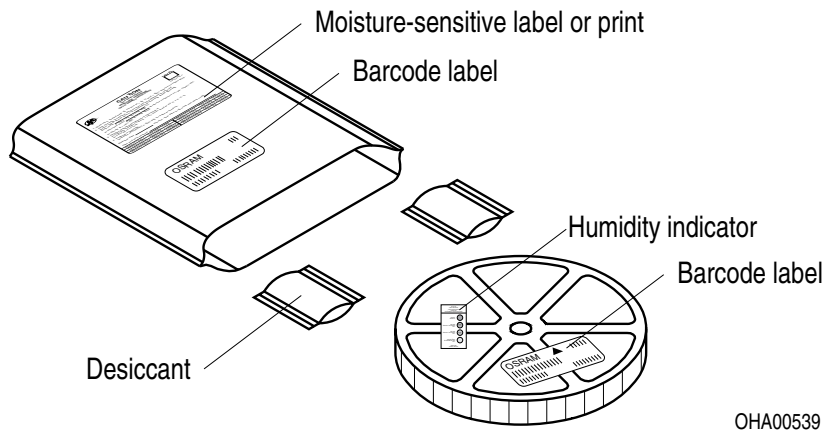

Moisture-sensitive product is packed in a dry bag containing desiccant and a humidity card according JEDEC-STD-033.

Transportation Packing and Materials ³⁾

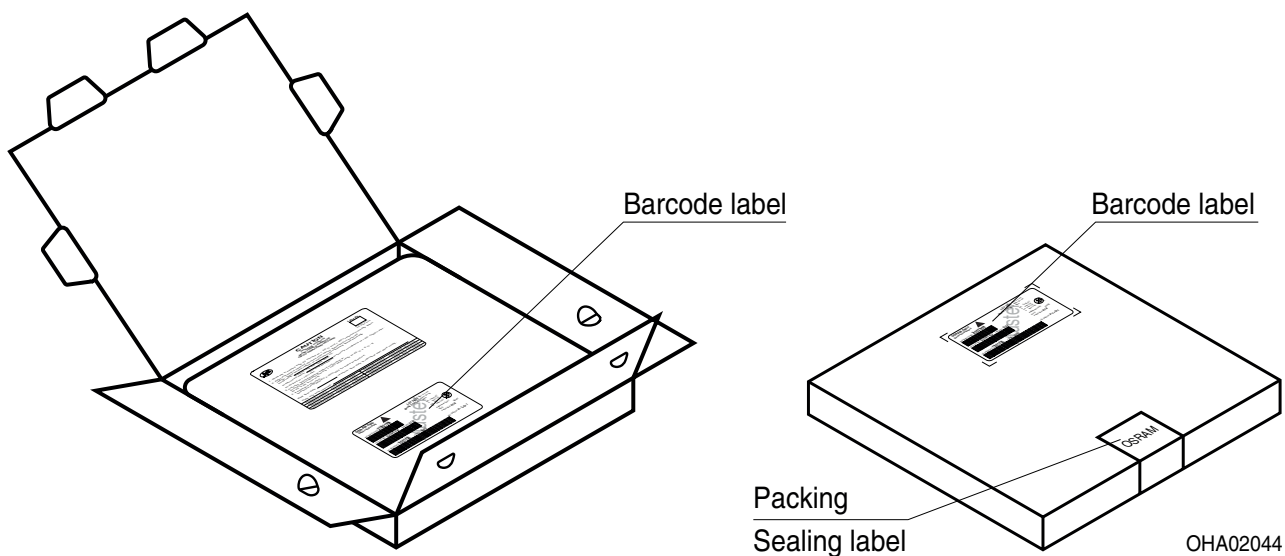

Dimensions of transportation box in mm

Width	Length	Height
200 ± 5 mm	195 ± 5 mm	30 ± 5 mm

Notes

The evaluation of eye safety occurs according to the standard IEC 62471:2006 (photo biological safety of lamps and lamp systems). Within the risk grouping system of this IEC standard, the LED specified in this data sheet fall into the class **exempt group (exposure time 10000 s)**. Under real circumstances (for exposure time, conditions of the eye pupils, observation distance), it is assumed that no endangerment to the eye exists from these devices. As a matter of principle, however, it should be mentioned that intense light sources have a high secondary exposure potential due to their blinding effect. When looking at bright light sources (e.g. headlights), temporary reduction in visual acuity and afterimages can occur, leading to irritation, annoyance, visual impairment, and even accidents, depending on the situation.

For further application related informations please visit www.osram-os.com/apnotes

Disclaimer

Disclaimer

Language english will prevail in case of any discrepancies or deviations between the two language wordings.

Attention please!

The information describes the type of component and shall not be considered as assured characteristics. Terms of delivery and rights to change design reserved. Due to technical requirements components may contain dangerous substances.

For information on the types in question please contact our Sales Organization.

If printed or downloaded, please find the latest version in the OSRAM OS Website.

Packing

Please use the recycling operators known to you. We can also help you – get in touch with your nearest sales office.

By agreement we will take packing material back, if it is sorted. You must bear the costs of transport. For packing material that is returned to us unsorted or which we are not obliged to accept, we shall have to invoice you for any costs incurred.

Product safety devices/applications or medical devices/applications

OSRAM OS components are not developed, constructed or tested for the application as safety relevant component or for the application in medical devices.

In case Buyer – or Customer supplied by Buyer– considers using OSRAM OS components in product safety devices/applications or medical devices/applications, Buyer and/or Customer has to inform the local sales partner of OSRAM OS immediately and OSRAM OS and Buyer and /or Customer will analyze and coordinate the customer-specific request between OSRAM OS and Buyer and/or Customer.

Glossary

- 1) **Typical Values:** Due to the special conditions of the manufacturing processes of LED, the typical data or calculated correlations of technical parameters can only reflect statistical figures. These do not necessarily correspond to the actual parameters of each single product, which could differ from the typical data and calculated correlations or the typical characteristic line. If requested, e.g. because of technical improvements, these typ. data will be changed without any further notice.
- 2) **Testing temperature:** $T_A = 25^\circ\text{C}$
- 3) **Tolerance of Measure:** Unless otherwise noted in drawing, tolerances are specified with ± 0.1 and dimensions are specified in mm.
- 4) **Tape and Reel:** All dimensions and tolerances are specified acc. IEC 60286-3 and specified in mm.

Published by OSRAM Opto Semiconductors GmbH EU RoHS and China RoHS compliant product
Leibnizstraße 4, D-93055 Regensburg
www.osram-os.com © All Rights Reserved.



此产品符合欧盟 RoHS 指令的要求；
按照中国的相关法规和标准，不含有毒有害物质或元素。