

LQW18CNR56J00#

"#" indicates a package specification code.



< List of part numbers with package codes >
 LQW18CNR56J00D , LQW18CNR56J00J , LQW18CNR56J00B

Shape

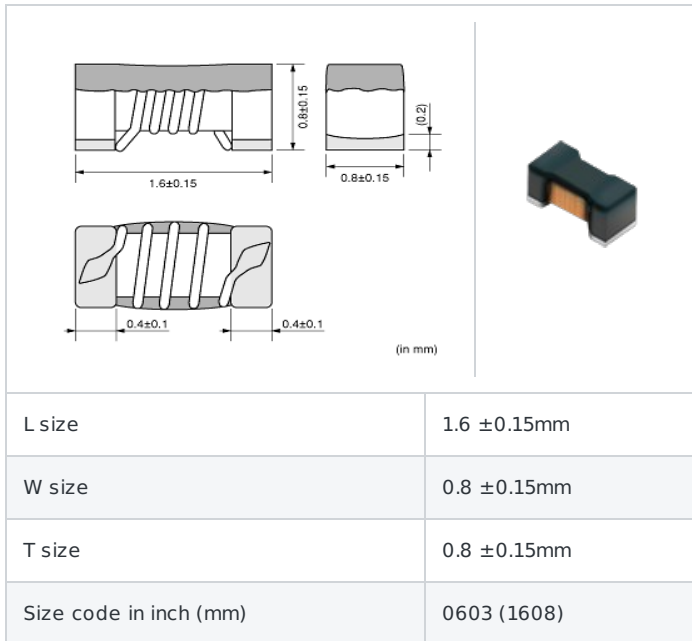

References

Packaging code	Specifications	Minimum quantity
D	φ 180mm Paper taping	4000
J	φ 330mm Paper taping	10000
B	Packing in bulk	500

Mass (Typ.)	
1 piece	0.004g

Specifications

Inductance	560nH ±5%
Inductance test frequency	10MHz
Rated current (Itemp) (Based on Temperature rise)	450mA
Max. of DC resistance	0.48Ω
Self resonance frequency (min.)	540MHz
Operating temperature range (Self-temperature rise is not included)	-40~85°C
Class of magnetic shield	No magnetic shield

⚠ Attention

- 1.This datasheet is downloaded from the website of Murata Manufacturing Co., Ltd. Therefore, it's specifications are subject to change or our products in it may be discontinued without advance notice. Please check with our sales representatives or product engineers before ordering.
- 2.This datasheet has only typical specifications because there is no space for detailed specifications. Therefore, please review our product specifications or consult the approval sheet for product specifications before ordering.

Chart of characteristic data (The charts below may show another part number which shares its characteristics.)

■ Inductance-Frequency characteristics (Typ.)

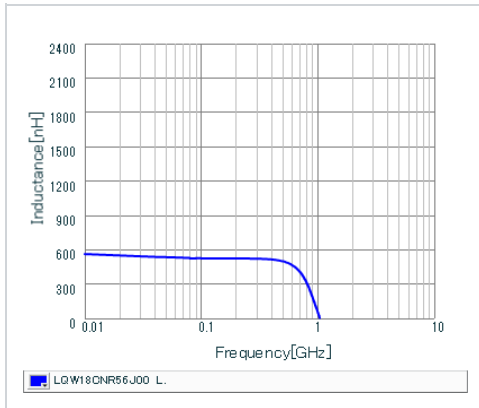

■ Inductance-Current characteristics (Typ.)

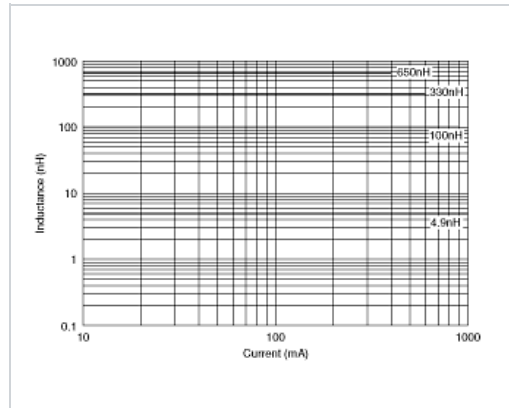

■ Impedance-Frequency characteristics (Typ.)

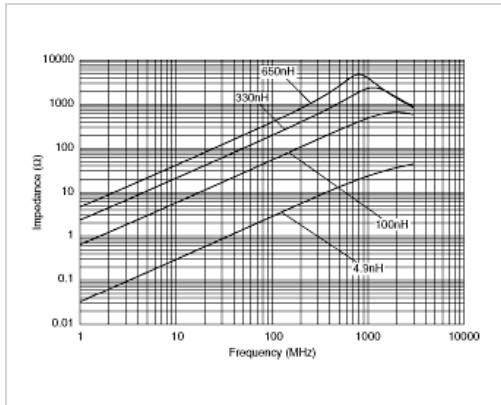

■ Q-Frequency characteristics (Typ.)

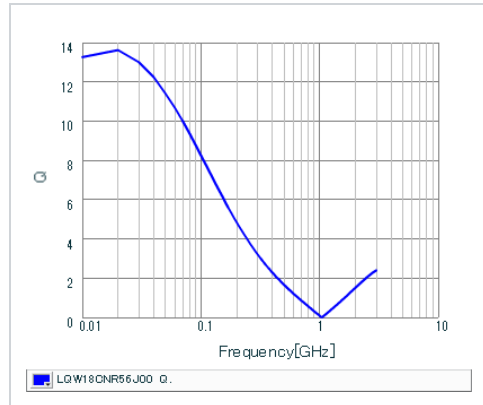

⚠ Attention

1. This datasheet is downloaded from the website of Murata Manufacturing Co., Ltd. Therefore, its specifications are subject to change or our products in it may be discontinued without advance notice. Please check with our sales representatives or product engineers before ordering.
2. This datasheet has only typical specifications because there is no space for detailed specifications. Therefore, please review our product specifications or consult the approval sheet for product specifications before ordering.