

High Density Zero Insertion Force (ZIF) Connectors

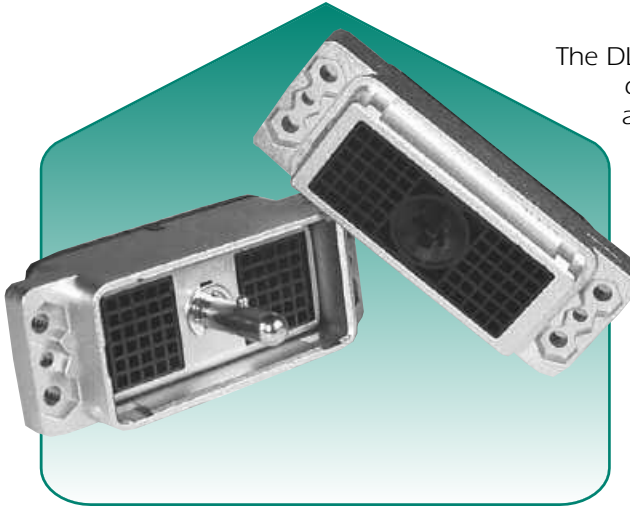

The DL, Zero Insertion Force Connector (ZIF) is a very versatile high density connector. It offers an economical solution for unique applications with a wide variety of sizes and accessories to an interconnect solution. These are suited for commercial/ industrial applications with the ease of no sliding force during mating & unmating. DL connectors can be found in various applications such as medical, sound, lighting & entertainment equipment. The new DLM shielded metal shell connector offers a stronger, light weight aluminum housing that is nickel plated for maximum shielding effectiveness along with great looks. Now available and fully intermatable with the 60, 96 and 156 contact versions, which have become an industry standard.

Applications

- Medical
 - Ultrasound Diagnostic
 - Patient Monitoring
 - Hospital Equipment
- Test & Instrumentation
 - Avionics
 - Automated Test Equipment
 - Computer & Peripheral Equipment
 - Semiconductor
- Commercial/Industrial Manufacturing
 - Automation
 - Robotics
 - Electrical Controls
- Entertainment
 - Recording Studio Equipment
 - Stage Lighting & Sound
 - Broadcasting Equipment
- Telecommunication
 - Systems Interconnect
 - Manufacturing Test Equipment
 - Switching Systems
- Transportation
 - Locomotive Systems
 - Automotive Electronics
 - Aircraft Simulators

Features

True Zero Insertion Force (ZIF) Connectors

There is no build up of mating force typically associated with high pin count style connectors. So mating and un-mating is as easy as twisting a handle.

Long Mating Life

10,000 matings minimum (100,000 for DLD drawer style) allows these connectors to be used in testing and burn in applications.

High Pin Count

60, 96, 156, 260, 360, 624, 1248, and even 2496 contacts make the DL series one of the highest pin count per connector available.

Wide Selections of Terminations

Crimp, printed circuit, square post, and solder buss style contacts give you maximum flexibility on how to wire your connectors.

New Nickel Plated Aluminum Housings

The DLM1/2/3 (60,96 & 156 pin) versions are now available in a strong metal shell fully EMI/RFI shielded version that can mate with the standard plastic housing version. This allows for easy upgrade to a shielded version without sacrificing intermatability of units already in the field.

Contact Wiping

During mating the contacts wipe lightly together which helps clean the contact mating area and assures low contact resistance needed for digital or low current applications.



Technical Specifications

MATERIALS & FINISHES

Shells	DL1/2/3	Glass filled thermoplastic, UL94V1 rated, Color: Black
	DL4	Aluminum alloy, cadmium plated housing, clear anodized mounting plate
	DL5	Glass filled thermoplastic, UL94V0 rated, Color: Black
	DLD1/2	Glass filled thermoplastic, UL94V1 rated, Color: Black
	DLM1/2/3/5/6	Aluminum alloy, nickel plated
Actuators & Plug insert retainers		Stainless steel, passivated
Spring Mounting Screws (DLD)		Stainless steel, passivated
Compression Spring (DLD)		Music wire, zinc plated
Contacts		Copper alloy
Plating		
	Crimp	50μ inches gold over 50μ inches nickel mating area gold flash on balance
	Crimp	20μ inches gold over 50μ inches nickel mating area tin lead on balance
	Square Post	50μ inches gold over 50μ inches nickel mating area gold flash on balance
	Square Post	20μ inches gold over 50μ inches nickel mating area gold flash on balance
	PC/RC	20μ inches gold over 50μ inches nickel mating area tin lead on balance
Insulators		
	DL4	Glass filled thermoplastic, UL94V1 rated, Color: Grey
	DLM1/2/3/5/6	Glass filled thermoplastic, UL94V0 rated, Color: Black

ELECTRICAL

Dielectric Withstanding Voltage	1200 Vac RMS – Crimp & square post contacts 1000 Vac RMS – PC/RC round PCB contacts 750 Vac RMS – DL4
Current Rating	5 Amps maximum – Crimp & square post contacts 4 Amps maximum – PC/RC contact 10 Amps up to 60 Amps maximum for buss contacts

**DL1
DLM1
DLD1**

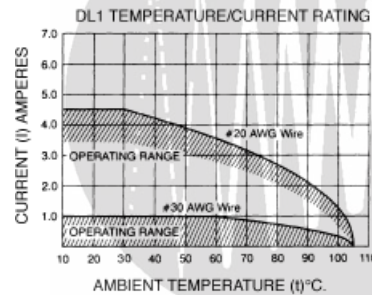

**DL2
DLM2
DLD2**

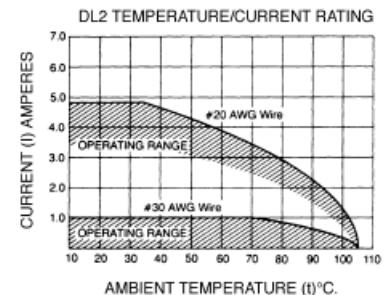

**DL3
DLM3**

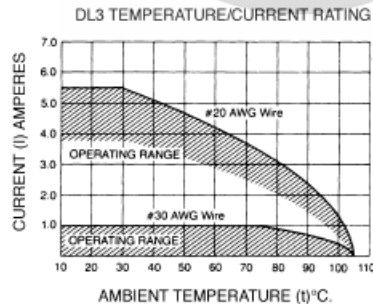

DL4

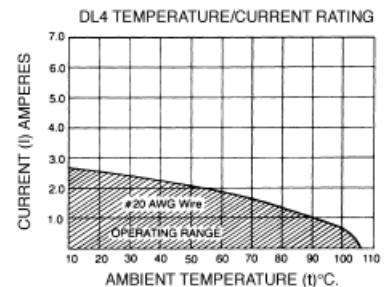

Note: The Ambient Temperature Curves shown represent the rated current carrying capacity of the Cannon DL1/2/3/4, DLM1/2/3, and DLD1/2 electrical connectors, derated to 80% of the value recorded using the methods specified by International Electro-Technical Commission Document 48 (1975).

Current was applied to the total connector (all contacts) in one-half ampere increments and maintained at each current level until thermal stability was achieved. A thermocouple inserted into the "hottest area" of each connector then measured the connector temperature at the same time that an ambient temperature reading was taken. The difference between the two measured values is the heat rise or self-heating created solely by the current flow, and this temperature rise for the current level was deducted from the insulator material rated temperature. These values were then derated to 80% to obtain the curves shown.

Wire Range Sizes	32 AWG – 18 AWG
Contact Resistance	15 milliohms maximum – Crimp & square post contacts 20 milliohms maximum – Crimp 32-30 AWG contacts 30 milliohms maximum – PC/RC contacts
Insulation Resistance	5000 megohms minimum



Technical Specifications

MECHANICAL

Operating Temperature	-55°C to 105°C: DL4 -55°C to 71°C																			
Durability	10,000 Mating cycles minimum DL/DLM 20,000 Mating cycles minimum DL4 100,000 Mating cycles minimum DLD																			
Insulation Strip Length	32 to 22 AWG .130" (3.30mm) 20 to 18 AWG .160" (4.06mm)																			
Insulation Diameter	30 to 28 AWG .053 (1.35mm) maximum 26 to 24 AWG .065 (1.65mm) maximum 22 to 18 AWG .074 (1.88mm) maximum																			
Crimp Tensile Strength min. lbs.	<table border="1"> <thead> <tr> <th>AWG</th> <th>Lbs.</th> </tr> </thead> <tbody> <tr><td>32</td><td>1</td></tr> <tr><td>30</td><td>1.5</td></tr> <tr><td>28</td><td>3</td></tr> <tr><td>26</td><td>10</td></tr> <tr><td>24</td><td>15</td></tr> <tr><td>22</td><td>15</td></tr> <tr><td>20</td><td>19</td></tr> <tr><td>18</td><td>30</td></tr> </tbody> </table>		AWG	Lbs.	32	1	30	1.5	28	3	26	10	24	15	22	15	20	19	18	30
AWG	Lbs.																			
32	1																			
30	1.5																			
28	3																			
26	10																			
24	15																			
22	15																			
20	19																			
18	30																			
Chemical Resistance	Salt spray per MIL-STD-202 method 101 Condition B (48 hours)																			
Vibration	Per MIL-STD-202 method 204 Condition C Per MIL-STD-167-1/2 Modified (DL4)																			
Shock	Per MIL-STD-202 method 213 Condition A (50g's)																			
Contact Type	Crimp, wire wrap, printed circuit board, Bus contacts -solder or crimp lug tab																			
Number of Circuits	60-2496																			
Contact Insertion	Hand insertable from rear no insertion tool required																			
Contact Retention	8 lbs. (35.585 newtons) minimum																			
Contact Spacing	.100" (25.4mm) square grid																			
Polarization	By center and/or corner polarizing post kit																			
Approvals	UL94V1 and UL94V0 materials																			

How DL/DLM Hand Actuated Connectors Work

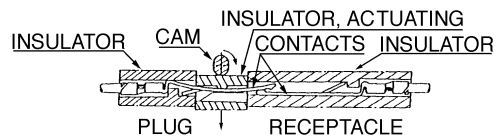
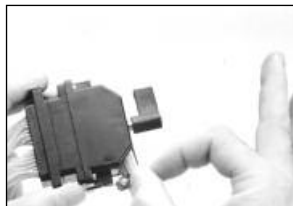
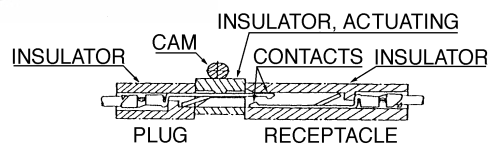
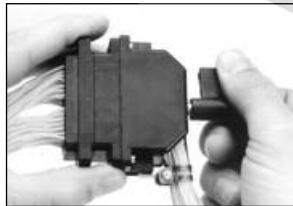
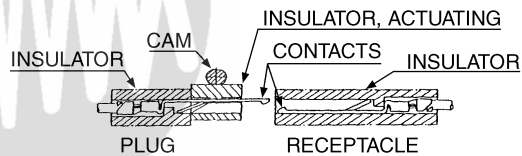
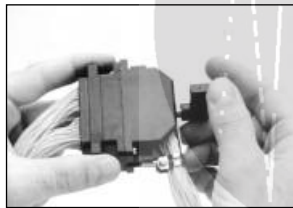

How DLD Drawer Style Connectors Work

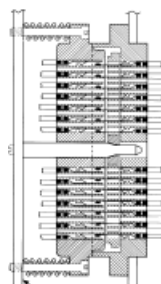
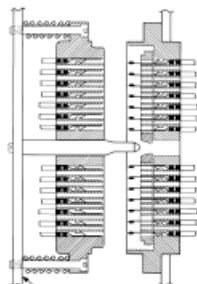

How To Order DL/DLM

Plugs

Number of Contacts	PC Tail .280" (7.11mm) Square .025 (.64mm)				PC Tail Round .280" (7.11mm) dia.020 (.50mm)	
	Non Shielded		Shielded			
	50 μ " Gold	20 μ " Gold	50 μ " Gold	20 μ " Gold	20 μ " Gold	
60	-	Call	DLM3-60PW6A 112138-0000	DLM3-60PW6 112138-0001	DLM3-60PC 127050-0223	
96	DL2-96PW6A 110777-0025	Call	DLM2-96PW6A 112136-0000	DLM2-96PW6 112136-0001	DLM2-96PC 127050-0215	
156	DL1-156PW6A 110535-0030	DL1-156PW6 110535-0026	DLM1-156PW6A 112134-0000	DLM1-156PW6 112134-0001	DLM1-156PC 127050-0207	
260	DL5-260PW6A 111986-0000	Call	DLM5-260PW6A 112086-0000	DLM5-260PW6 112086-0002	DLM5-260PC 127050-0111	
360	Call	Call	DLM6-360PW6A 111995-0000	DLM6-360PW6 111995-0001	DLM6-360PC 127050-0097	
624	DL4-624PW6A 110959-0042	Call	-	-	-	
1248	Call	Call	-	-	-	
2496	Call	Call	-	-	-	

Receptacles

Number of Contacts	PC Tail .280" (7.11mm) Square .025 (.64mm)				PC Tail Round .280" (7.11mm) dia.020 (.50mm)	
	Non Shielded		Shielded			
	50 μ " Gold	20 μ " Gold	50 μ " Gold	20 μ " Gold	20 μ " Gold	
60	DL3-60RW6B 110901-0010	Call	DLM3-60RW6B 112139-0000	-	DLM3-60RC 127050-0227	
96	DL2-96RW6B 110855-0014	Call	DLM2-96RW6B 112137-0000	-	DLM2-96RC 127050-0366	
156	DL1-156RW6B 110536-1007	DL1-156RW6 110536-1009	DLM1-156RW6B 112135-0000	-	DLM1-156RC 127050-0211	
260	DL5-260RW6B 111987-0000	Call	DLM5-260RW6B 112087-0000	-	DLM5-260RC 127050-0112	
360	Call	Call	DLM6-360RW6B 111996-0001	-	DLM6-360RC 127050-0098	
624	DL4-624RW6B 110960-0048	Call	-	-	-	
1248	Call	Call	-	-	-	
2496	Call	Call	-	-	-	

How To Order DL/DLM

PC Wire Wrap/PC Tail .605" (15.37 mm) Square .025 (.64mm)		PC Wire Wrap/Tail Length .125" (3.18mm) Square .025 (.64mm)		For Crimp and Insert Contacts		
Non Shielded		Shielded 50 50µ" Gold	Non Shielded 50 50µ" Gold	Shielded 50 50µ" Gold	Non Shielded	Shielded
50µ" Gold	20µ" Gold					
DL3-60PW4A 110900-0013	DL3-60PW4 110900-0006	DLM3-60PW4A 112138-0001	Call	DLM3-60P w/.125 112138-0002	DL3-60P 110900-0008	DLM3-60P 127050-0220
DL2-96PW4A 110777-0022	DL2-96PW4 110777-0008	DLM2-96PW4A 112136-0001	Call	DLM2-96P w/.125 112136-0002	DL2-96P 110777-0000	DLM2-96P 127050-0212
DL1-156PW4A 110535-0025	DL1-156PW4 110535-0012	DLM1-156PW4A 112134-0001	DL1-156P w/.125 110535-0040	DLM1-156P w/.125 112134-0002	DL1-156P 110535-0000	DLM1-156P 127050-0204
DL5-260PW4A 111986-0003	Call	DLM5-260PW4A 112086-0002	Call	DLM5-260P w/.125 112086-0003	DL5-260P 111986-0014	DLM5-260P 127050-0109
-	Call	DLM6-360PW4A 111995-0001	Call	DLM6-360P w/.125 111995-0007	-	DLM6-360P 127050-0034
DL4-624PW4A 110959-0035	DL4-624PW4 110959-0011	-	Call	-	DL4-624P 110959-0002	-
Call	Call	-	Call	-	DL4-1248P 110959-0003	-
Call	Call	-	Call	-	DL4-2496P 110959-0004	-

PC Wire Wrap/PC Tail .605" (15.37 mm) Square .025 (.64mm)		PC Wire Wrap/Tail Length .125" (3.18mm) Square .025 (.64mm)		For Crimp and Insert Contacts		
Non Shielded		Shielded 50 50µ" Gold	Non Shielded 50 50µ" Gold	Shielded 50 50µ" Gold	Non Shielded	Shielded
50µ" Gold	20µ" Gold					
DL3-60RW4B 110901-0009	DL3-60RW4 110901-0004	DLM3-60RW4B 112139-0001	Call	DLM3-60R w/.125 112139-0002	DL3-60R 086-0032-000	DLM3-60R 127050-0224
DL2-96RW4B 110855-0013	DL2-96RW4 110855-0008	DLM2-96RW4B 112137-0001	Call	DLM2-96R w/.125 112137-0002	DL2-96R 086-0031-000	DLM2-96R 127050-0216
DL1-156RW4B 110536-1006	DL1-156RW4 110536-1003	DL1-156RW4B 112135-0001	DL1-156R w/.125 110536-1011	DLM1-156R w/.125 112135-0002	DL1-156R 086-0030-000	DLM1-156R 127050-0208
DL5-260RW4B 111987-0001	Call	DLM5-260RW4B 112087-0001	Call	DLM5-260R w/.125 112087-0003	DL5-260R 086-4501-000	DLM5-260R 127050-0110
-	Call	DLM6-360RW4B 111996-0000	Call	DLM6-360R w/.125 111996-0005	-	DLM6-360R 127050-0045
DL4-624RW4B 110960-0045	DL4-624RW4 110960-0022	-	Call	-	DL4-624R 110960-0002	-
Call	Call	-	Call	-	DL4-1248R 110960-0003	-
Call	Call	-	Call	-	DL4-2496R 110960-0004	-

DL/DLW/DLM

How to Order DLD

Plugs

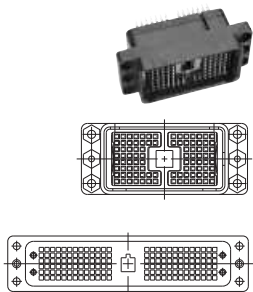

Number of Contacts	PC Tail .280" (7.11mm) Square .025 (.64mm) 50 microinches	PC Wire Wrap /PC Tail .605" (15.37mm) Square .025 (.64mm) 50 microinches	For Crimp and Insert Contacts
96	DLD2-96PW6A 111922-0002	DLD2-96PW4A 111922-0001	DLD2-96P 111922-0000
156	DLD1-156PW6A 111496-0002	DLD1-156PW4A 111496-0001	DLD1-156P 111496-0000

Receptacles

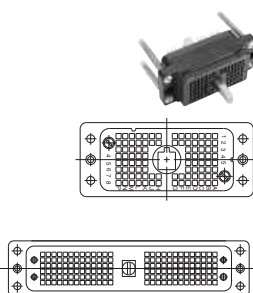

Number of Contacts	PC Tail .280" (7.11mm) Square .025 (.64mm) 50 microinches	PC Wire Wrap /PC Tail .605" (15.37mm) Square .025 (.64mm) 50 microinches	For Crimp and Insert Contacts
96	DLD2-96RW6B 111921-0002	DLD2-96RW4B 111921-0001	DLD2-96R 111921-0000
156	DLD1-156RW6B 111497-0010	DLD1-156RW4B 111497-0009	DLD1-156R 111497-0004

Accessories

Connector Style	Plug Actuating Handles	Plug Protective Covers	Receptacle Protective Covers	Metal Backshell	Max. Cable Size
DL/DLM3-60	204-0016-000	039-0246-000 025-0850-000†	039-0247-000	249-4518-000	.750 (19.05)
DL/DLM2-96		039-0244-000 025-0851-000†	039-0245-000	249-4517-000	
DL/DLM1-156		039-0242-000 025-0852-000†	039-0243-000	249-4520-000	
DL/DLM5-260	204-4501-000	-	-	249-4501-000	.875 (22.23)
DL/DLM6-360	204-4500-000	-	-	249-4515-000	1.102 (28.00)
DL4-624	-	039-0239-000	039-0240-000	-	-
DL4-1248	-	039-0245-000	039-0236-000	-	-

† Low cost plastic

Dimensions are in inches (mm).

See back cover for contact details • www.Peigenesis.com

Specifications subject to change.

PCB Pad Layout

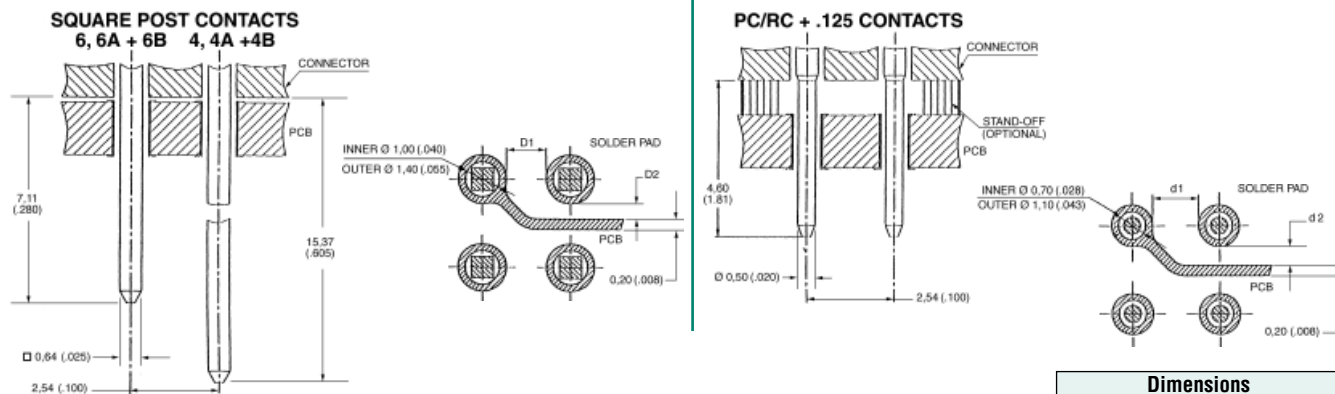

For the PC/RC versions: The contact tail design has been modified from a 0.64 (.025) square pin to a 0.05 (.020) diameter round pin. The change enables a decrease in the diameter of the through holes as well as the solder mounds on PCBs (d1, and d2 can be wider than D1 and D2). This can reduce the crosstalk in RF circuits and enhance the dielectric withstanding voltage in high voltage circuits.

Dimensions	
D1	1.14(.045)
D2	0.47(.018)
d1	1.44(.057)
d2	0.82(.024)

The soldering of contacts into through (THRU) holes on a PC Board has become standard for medical equipment and test equipment for semi-conductors. As a result of the narrow spacing between the solder pad and circuit pattern, crosstalk between signals increases. A solution to this problem is to make the diameter of the contacts and solder lands smaller to provide more space between the lands and the patterns. However, a smaller diameter contact results in higher impedance.

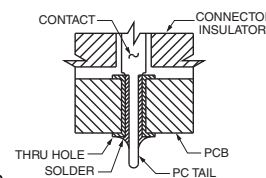

ITT Cannon designed a solution with a smaller diameter contact tail. This design application allows the use of a smaller through-hole diameter.

Accessories

Plastic Backshell	Cable Clamp for second entry in Plastic Backshell	Max Cable Size	Polarizing Posts	
			Corner (Note: post replaces nut)	Center
249-2060-000 249-2237-000 249-2237-001 249-2060-001 ▲	218-0180-000 218-0181-000 218-0200-000 218-0181-000	.560(14.20mm) .625(15.90mm) .875(22.23mm) .625(15.90mm) 45°	320-0021-006 DL 320-4505-000 DLM	-
249-1985-000 249-2238-000 249-2238-001 249-1985-001 ▲	218-0180-000 218-0181-000 218-0200-000 218-0181-000	.560(14.20mm) .625(15.90mm) .875(22.23mm) .625(15.90mm) 45°		320-0021-005
249-1950-000	218-0179-000	.875(22.23mm)	320-0021-006 DL	
-	-	-	320-4502-000	-
-	-	-	320-0021-006	-
-	-	-	-	-
-	-	-	-	-

▲ 45 Degree Cable Entry

Dimensions are in inches (mm).

Contacts

Bump & Flat Contacts

Wire Size AWG	Plating Mating Area Balance of contact	Bump Contacts for Plugs/Receptacles		Flat Contacts for Plugs/Receptacles		Wire Strip Length	Maximum Insulation Diameter	Hand Crimp Tool	Extraction Tool			
		Loose	10,000 Piece Reel*	Loose	10,000 Piece Reel*							
		28-32	50 μ " Gold-Gold Flash	030-2416-003	110238-0482					030-2494-001	110238-0486	.130 (3.30)
	20 μ " Gold-Tin Lead	030-2416-001	110238-0403	-	-							
24-26	50 μ " Gold-Gold Flash	030-2410-003	110238-0480	030-2492-001	110238-0484	.160 (4.06)	.074 (1.88)	112108-0001				
		20 μ " Gold-Tin Lead	030-2410-001	110238-0401	-				-			
20-22	50 μ " Gold-Gold Flash	030-2409-003	110238-0479	030-2491-001	110238-0483				.160 (4.06)	.074 (1.88)	112108-0000	
		20 μ " Gold-Tin Lead	030-2409-001	110238-0400	-							-
18-20	50 μ " Gold-Gold Flash	030-2415-003	110238-0481	030-2493-001	110238-0485	.160 (4.06)	.074 (1.88)	112108-0000				
		20 μ " Gold-Tin Lead	030-2415-001	110238-0402	-				-			

For applications that will have over 100 milliamps bump, contact may be used in both plugs and receptacle housings. Flat contacts provide excellent wiping action, can always be used in receptacle housings, and are required for applications using 100 milliamps or less.

*Call for Autocrimp Tool information.

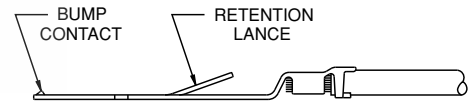

Dimensions are in inches (mm).

High Amperage Buss Contacts

Buss Number of Pairs	Plating Mating area-balance	Part Number	Maximum Current	Extraction Tool
1	20 μ " Gold-Gold Flash	030-7380-001	10 Amp	274-7029-003
2		030-7380-002	20 Amp	274-7029-004
3		030-7380-003	30 Amp	
4		030-7380-004	40 Amp	274-7029-005
5		030-7380-005	50 Amp	274-7029-006
6		030-7380-006	60 Amp	

Note: DL buss contacts will accommodate 18-30 AWG wires for soldering or 1/8" crimp lugs.

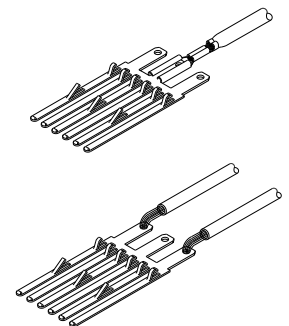

DL/DLM3-60 Dimensions

Plugs

FRONT

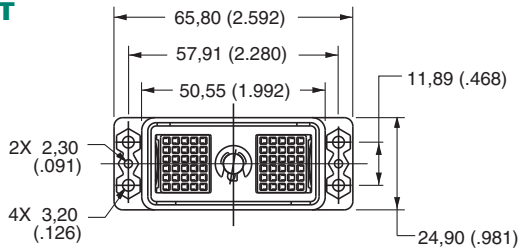

BACK

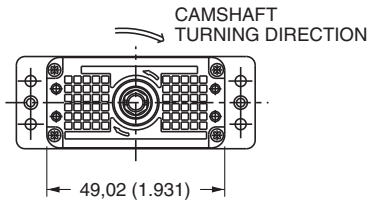

SIDE VIEWS

Contact Style	A
w/ .125	.125" (3.18)
4A, 4B	.605" (15.37)
6A, 6B	.280" (7.11)

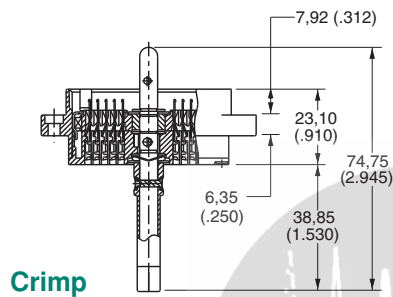

Crimp

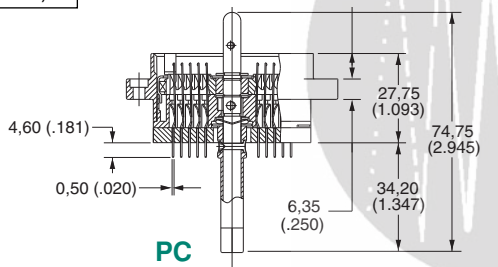

PC

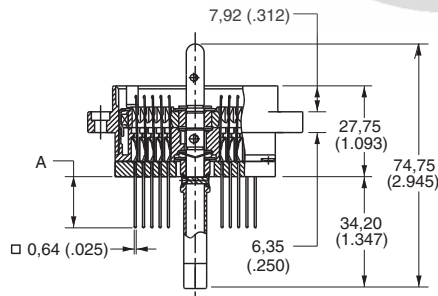

LAYOUT

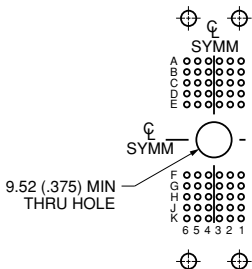

PANEL CUTOUT

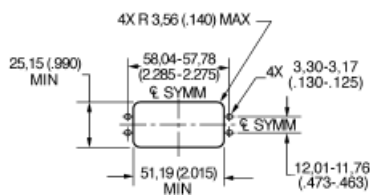

Receptacles

FRONT

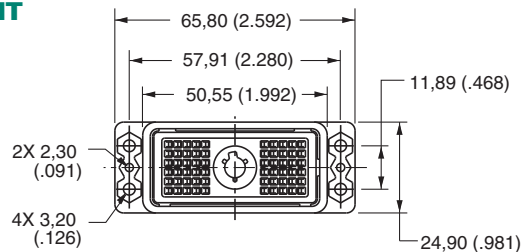

BACK

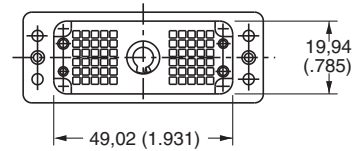

SIDE VIEWS

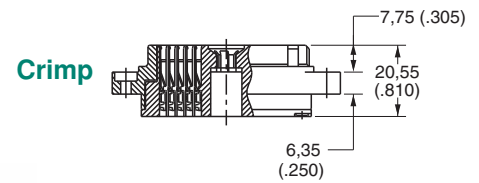

Crimp

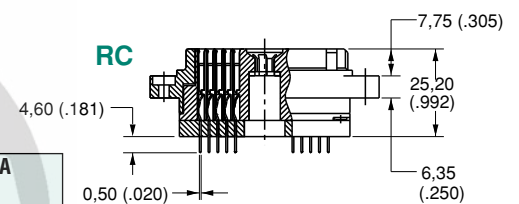

RC

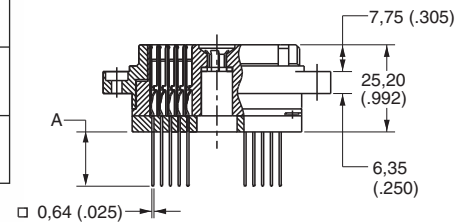

Contact Style	A
w/ .125	.125" (3.18)
4A, 4B	.605" (15.37)
6A, 6B	.280" (7.11)

LAYOUT

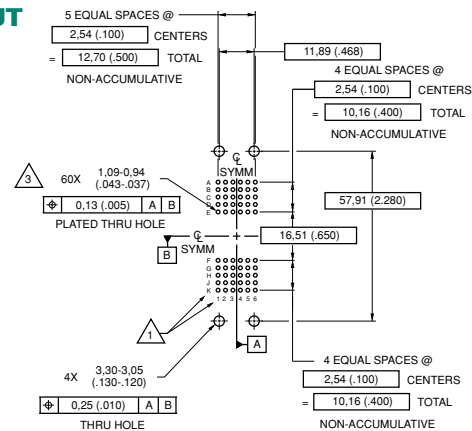

PANEL CUTOUT

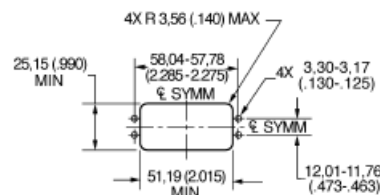

All dimensions are in mm (inches) unless otherwise indicated.

See back cover for contact details • www.PeiGenesis.com

Specifications subject to change.

DL/DLM2-96 Dimensions

Plugs

FRONT

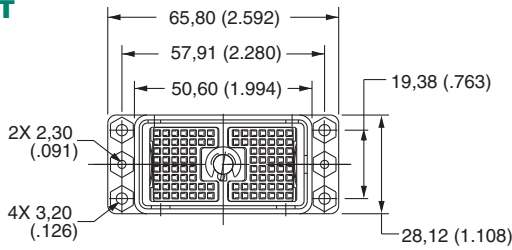

BACK

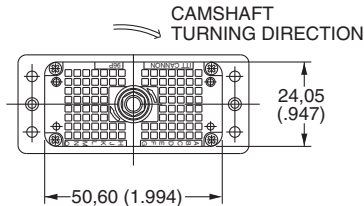

SIDE VIEWS

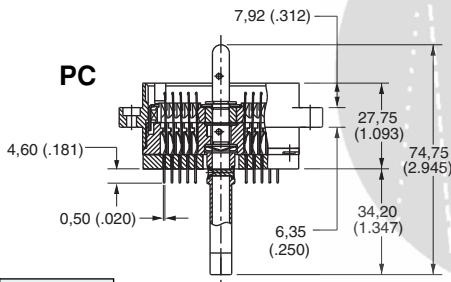
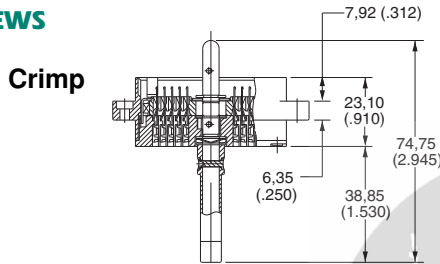

Contact Style	A
w/ .125	.125" (3.18)
4A, 4B	.605" (15.37)
6A, 6B	.280" (7.11)

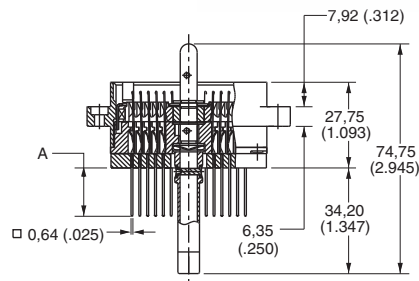

LAYOUT

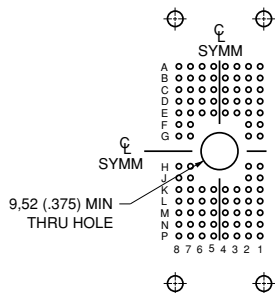

PANEL CUTOUT

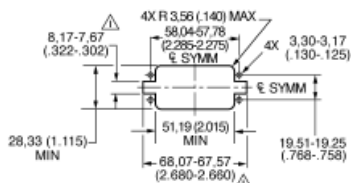

Receptacles

FRONT

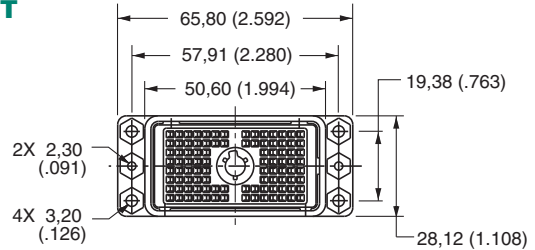

BACK

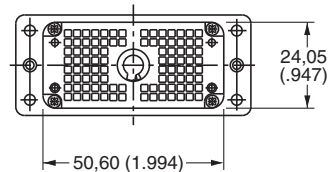

SIDE VIEWS

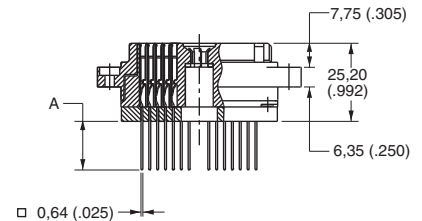
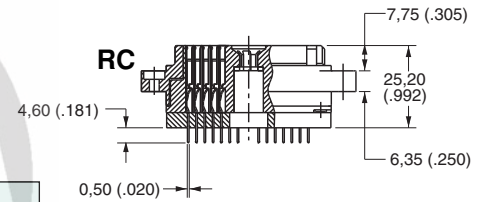
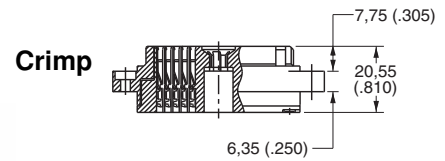

Contact Style	A
w/ .125	.125" (3.18)
4A, 4B	.605" (15.37)
6A, 6B	.280" (7.11)

LAYOUT

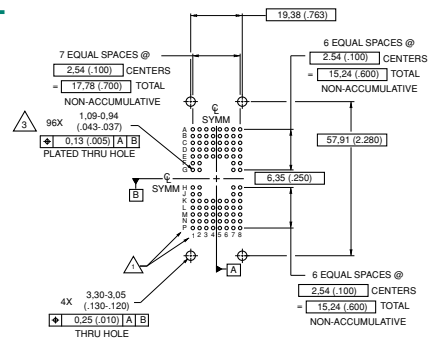

PANEL CUTOUT

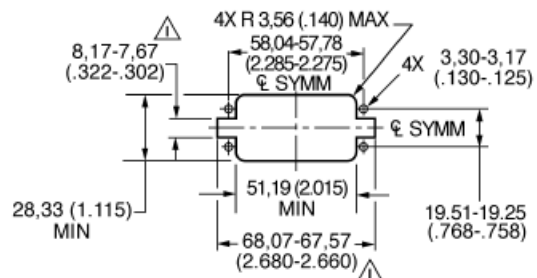

DLD2-96 Dimensions

Plugs

FRONT

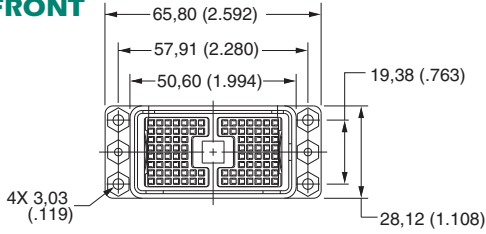

BACK

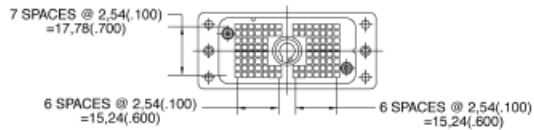

SIDE VIEWS

Crimp

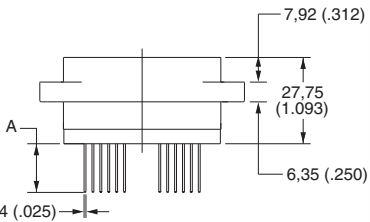
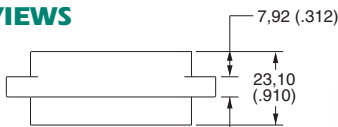

Contact Style	A
w/ .125	.125" (3.18)
4A, 4B	.605" (15.37)
6A, 6B	.280" (7.11)

LAYOUT

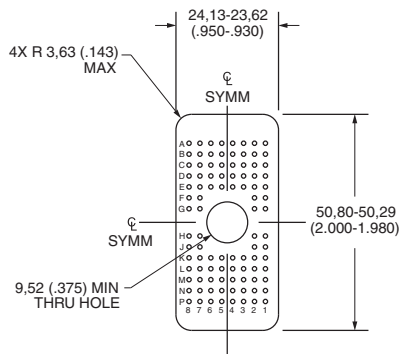

PANEL CUTOUT

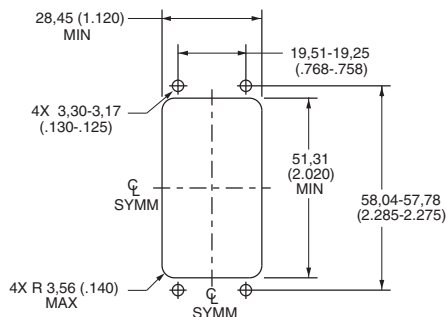

All dimensions are in mm (inches) unless otherwise indicated.

See back cover for contact details • www.Peigenesis.com

Receptacles

FRONT

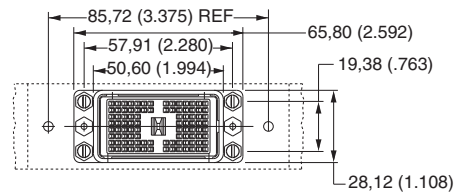

BACK

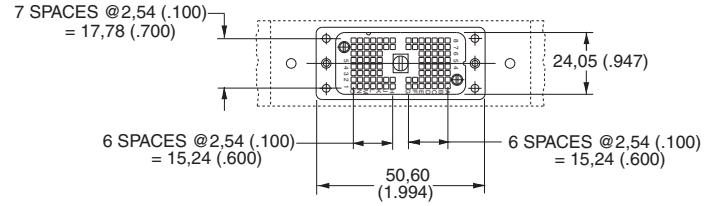

SIDE VIEWS

Crimp

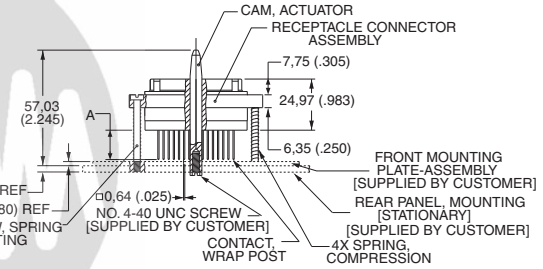
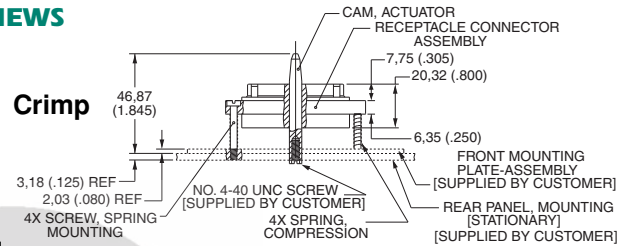

LAYOUT

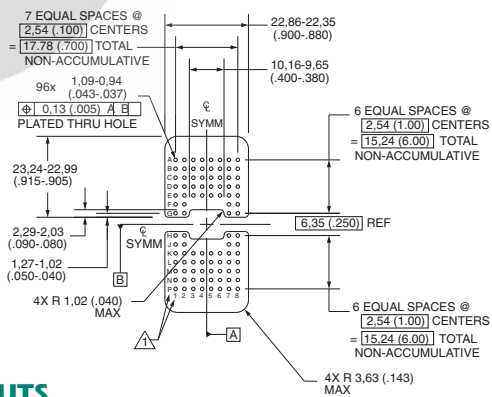

PANEL CUTOUTS

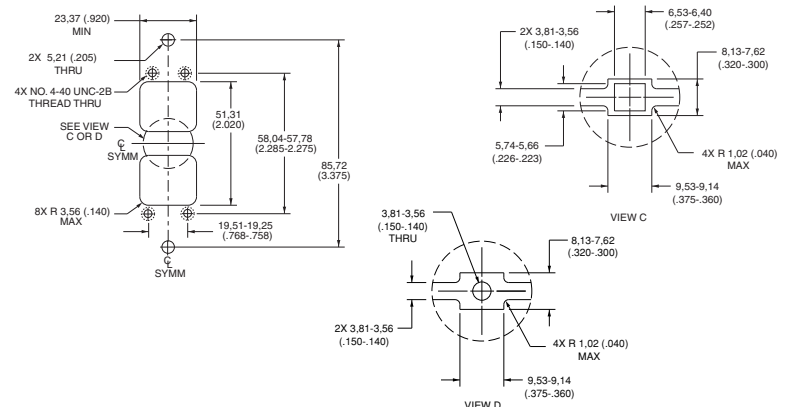

DLD/DLM

Specifications subject to change.

DL/DLM1-156 Dimensions

Plugs

FRONT

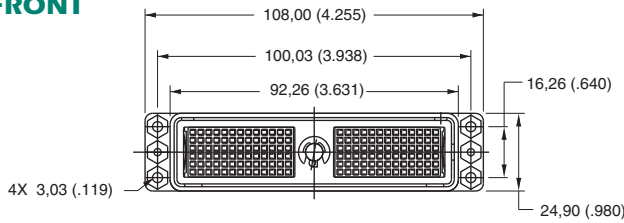

BACK

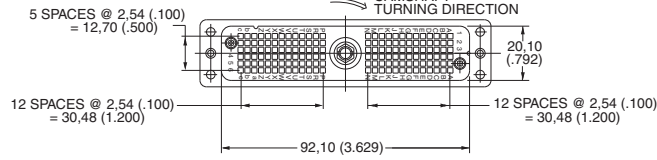

SIDE VIEWS

Crimp

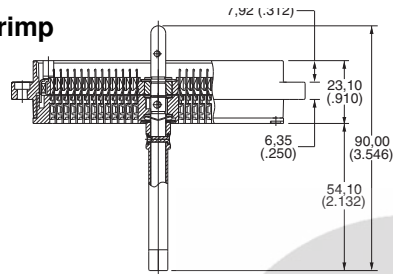

PC

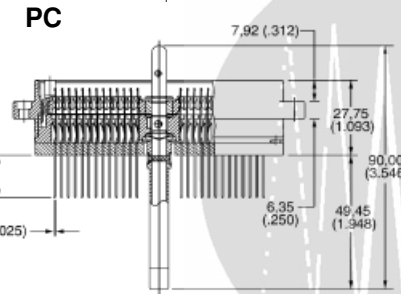

Contact Style	A
w/ .125	.125" (3.18)
4A, 4B	.605" (15.37)
6A, 6B	.280" (7.11)

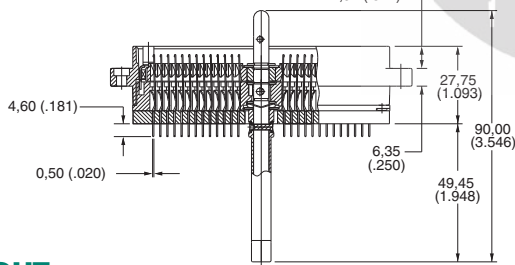

LAYOUT

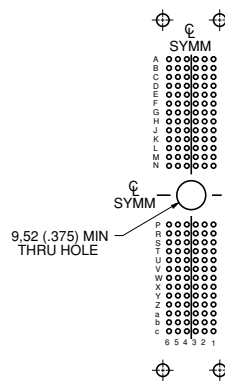

PANEL CUTOUT

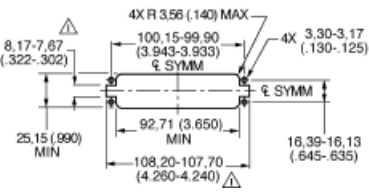

Receptacles

FRONT

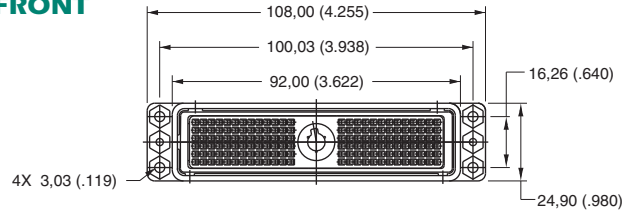

BACK

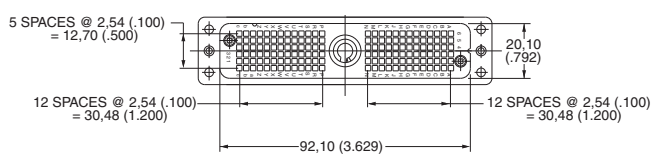

SIDE VIEWS

Crimp

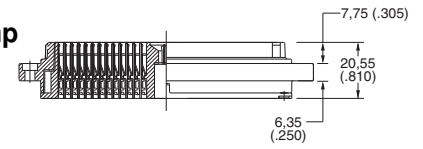

RC

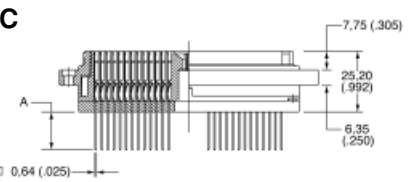

Contact Style	A
w/ .125	.125" (3.18)
4A, 4B	.605" (15.37)
6A, 6B	.280" (7.11)

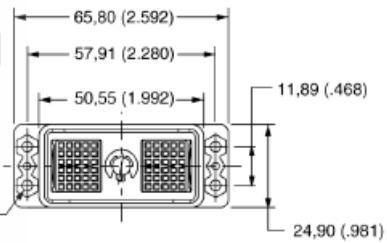

LAYOUT

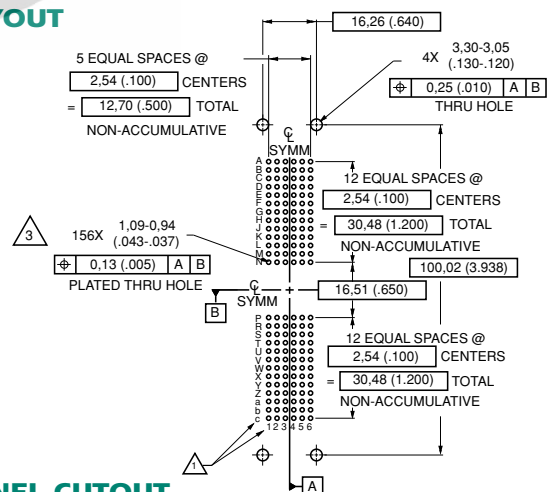

PANEL CUTOUT

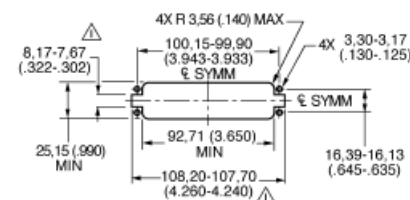

DL/DL/DLM

DLD1-156 Dimensions

Plugs

FRONT

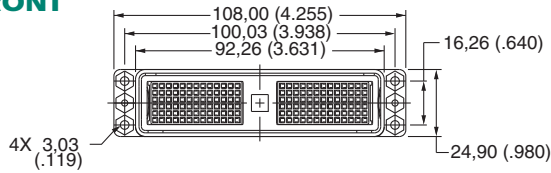

BACK

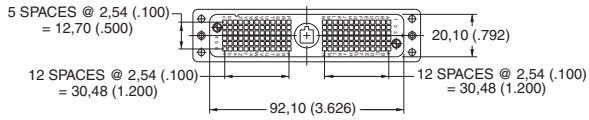

SIDE VIEWS

Crimp

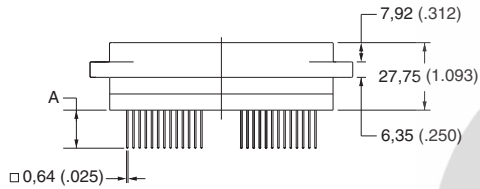
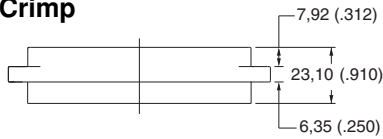

LAYOUT

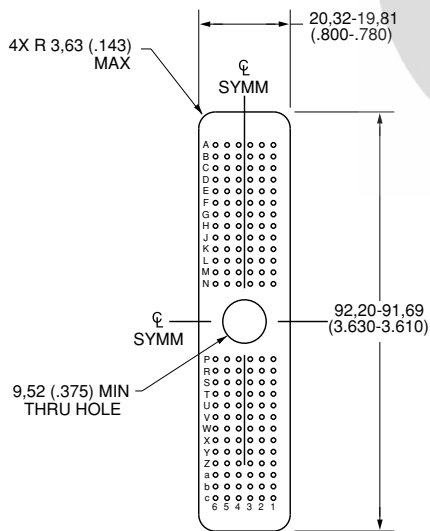

PANEL CUTOUT

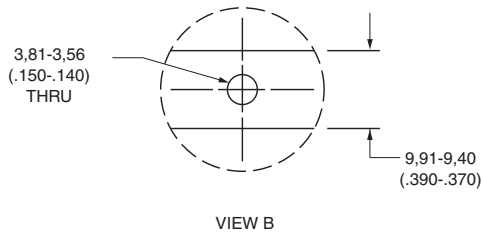

Receptacles

FRONT

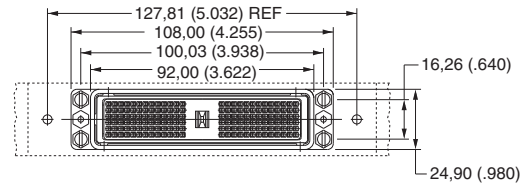

BACK

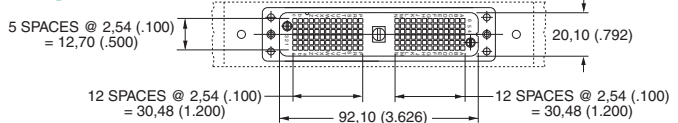

SIDE VIEWS

Crimp

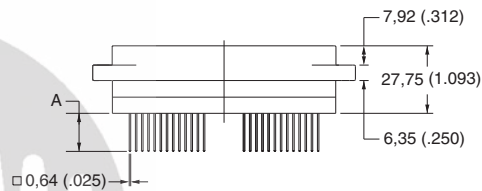
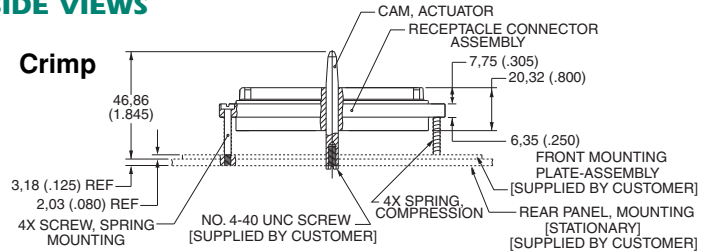

Contact Style	A
w/ .125	.125" (3.18)
4A, 4B	.605" (15.37)
6A, 6B	.280" (7.11)

LAYOUT

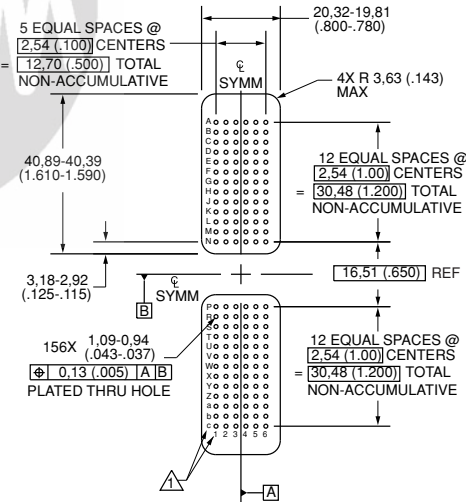

PANEL CUTOUTS

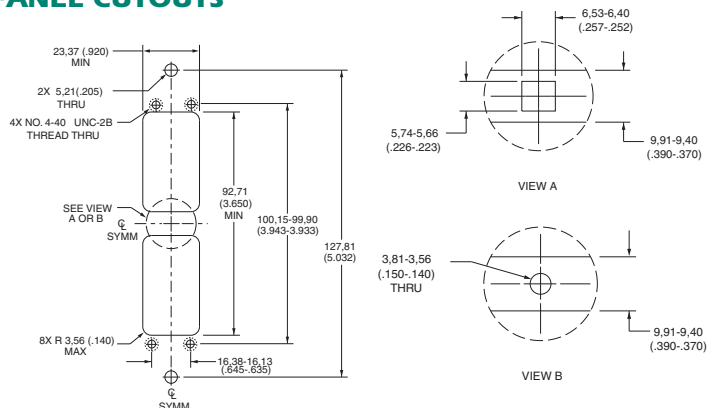

All dimensions are in mm (inches) unless otherwise indicated.

See back cover for contact details • www.PeiGenesis.com

Specifications subject to change.

DL/DLM5-260 Dimensions

Plugs

FRONT

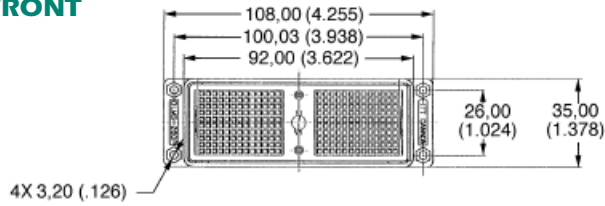

BACK

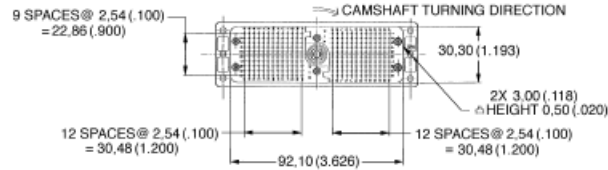

SIDE VIEWS

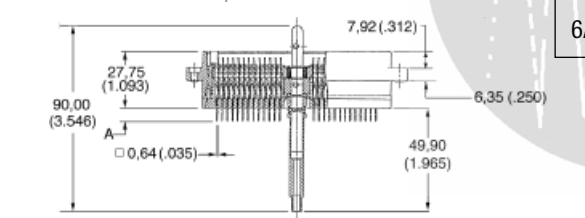
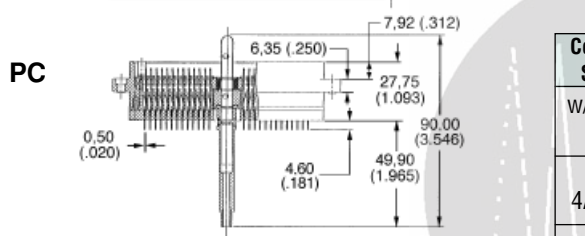
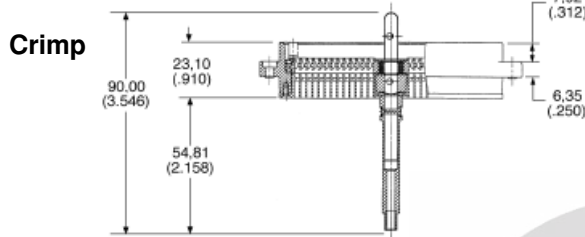

LAYOUT

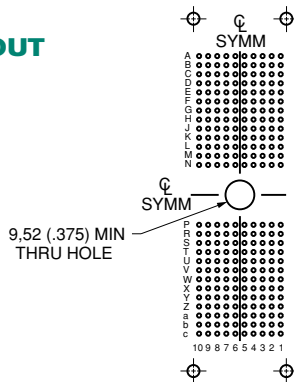

PANEL CUTOUT

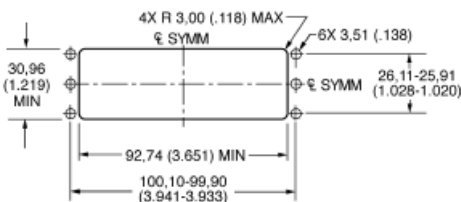

Receptacles

FRONT

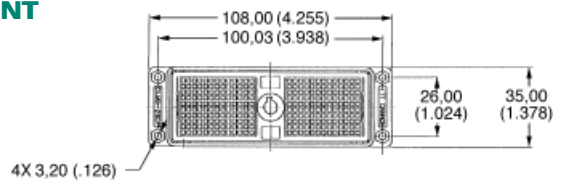

BACK

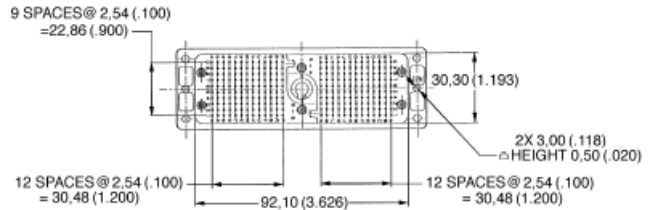

SIDE VIEWS

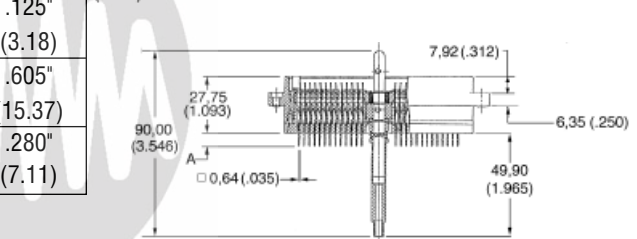
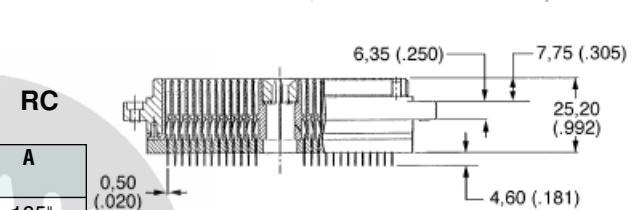
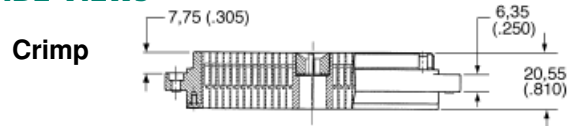

LAYOUT

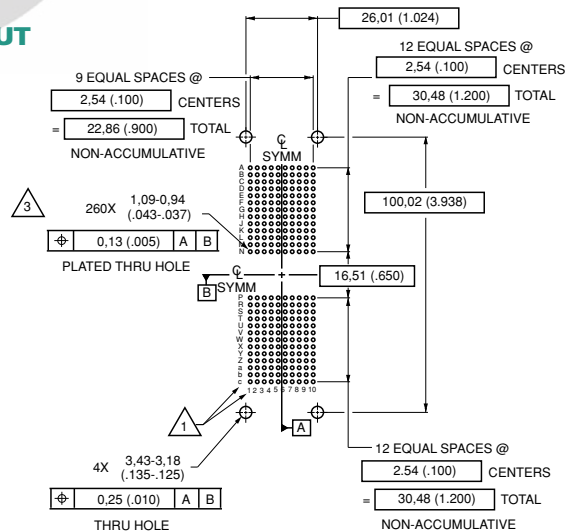

PANEL CUTOUT

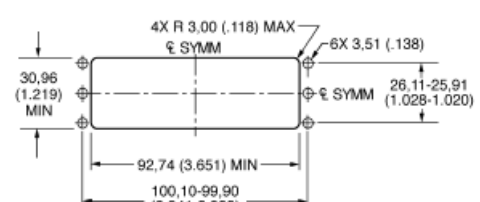

Contact Style	A
w/ .125	.125" (3.18)
4A, 4B	.605" (15.37)
6A, 6B	.280" (7.11)

DLM6-360 Dimensions

Plugs

FRONT

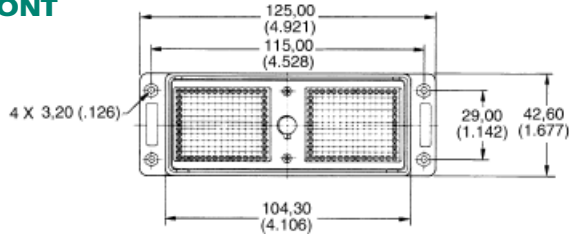

BACK

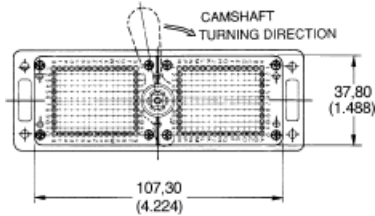

SIDE VIEWS

Crimp

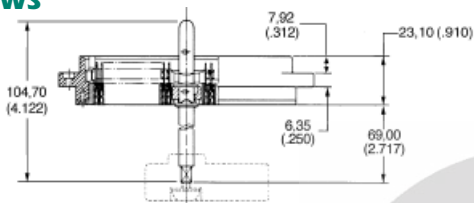

PC

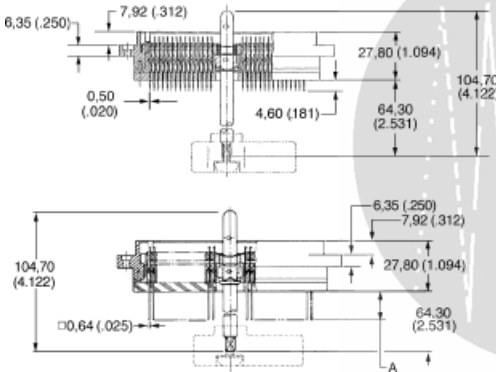

LAYOUT

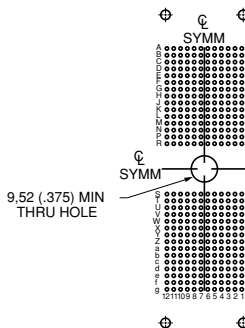

PANEL CUTOUT

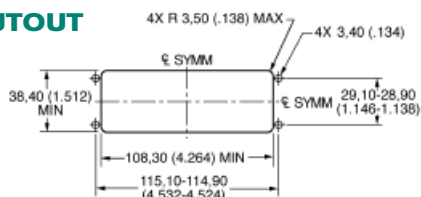

Receptacles

FRONT

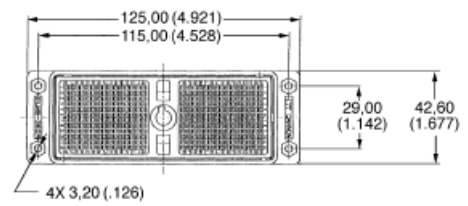

BACK

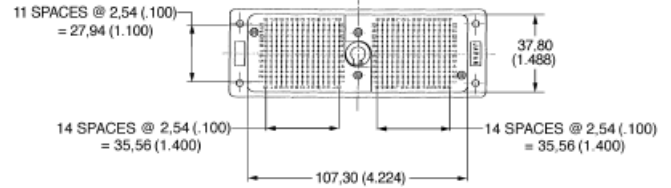

SIDE VIEWS

Crimp

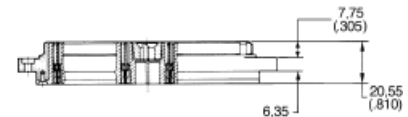

RC

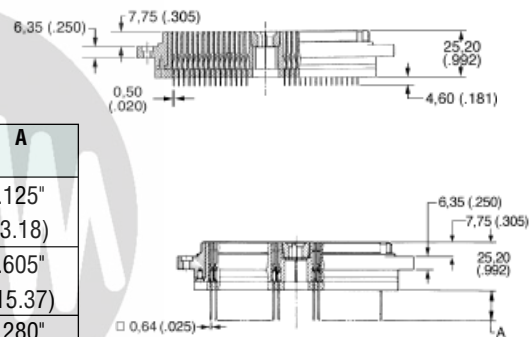

Contact Style	A
w/ .125	.125" (3.18)
4A, 4B	.605" (15.37)
6A, 6B	.280" (7.11)

LAYOUT

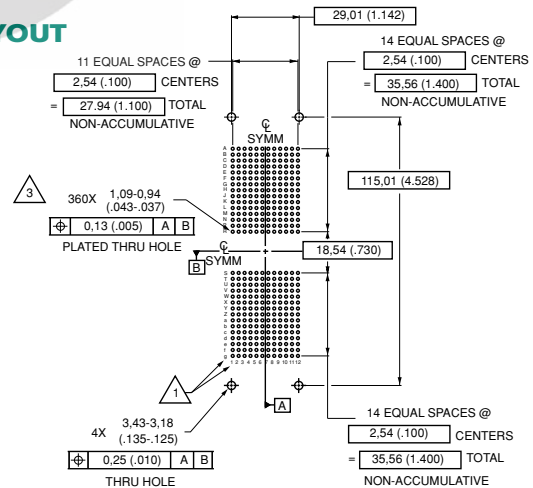

PANEL CUTOUT

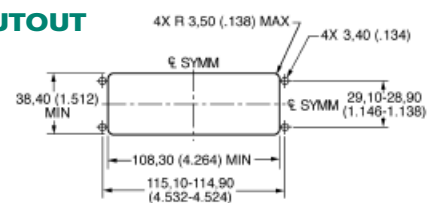

All dimensions are in mm (inches) unless otherwise indicated.

See back cover for contact details • www.PeiGenesis.com

Specifications subject to change.

DLD/DLM/DLM

DL4-624 Dimensions

Plugs

FRONT

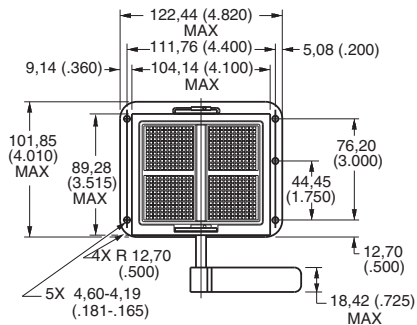

SIDE VIEWS

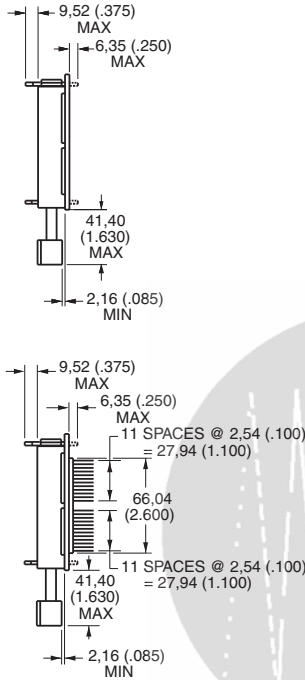

Crimp

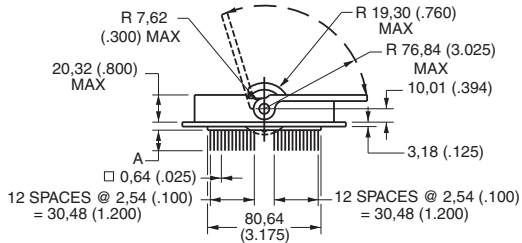
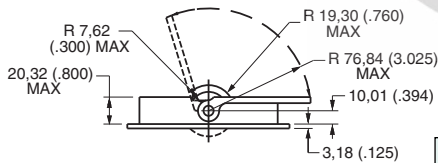

PANEL CUTOUT

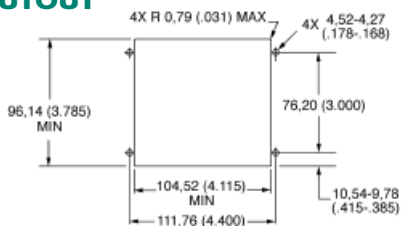

Receptacles

FRONT

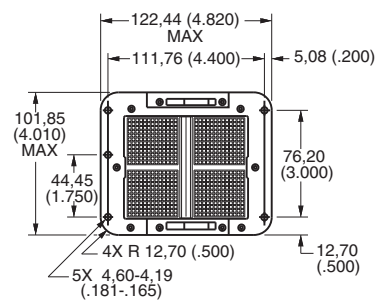

SIDE VIEWS

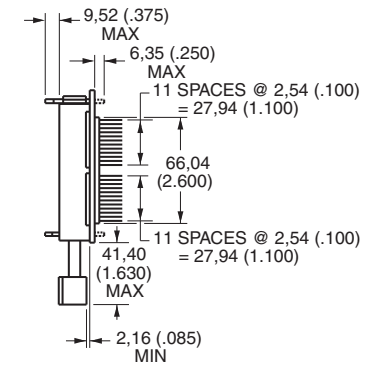
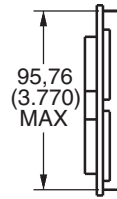

Crimp

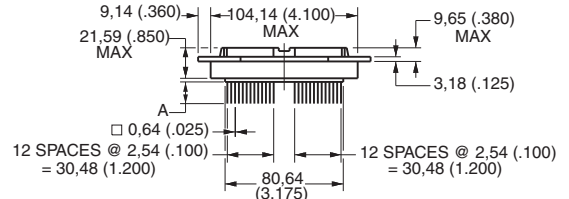
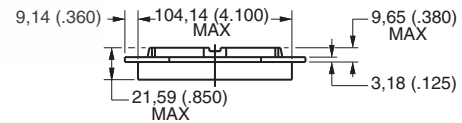

PANEL CUTOUT

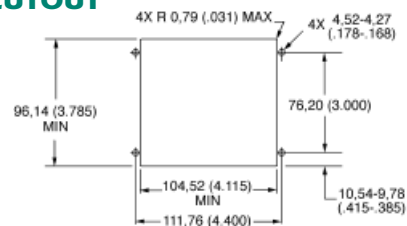

Contact Style	A
w/ .125	.125" (3.18)
4A, 4B	.605" (15.37)
6A, 6B	.280" (7.11)

Accessories

Connector Style	Plastic	Metal
DL/DLM3-60	<p>*CABLE CLAMP IN VERTICAL WIRE EXIT POSITION—EITHER END *CABLE CLAMP IN HORIZONTAL WIRE EXIT POSITION—EITHER END</p> <p>24,13 (.950) MAX 27,94 (1.100) MAX 39,29 (1.547) MAX 36,45 (1.435) MAX 30,05 (1.183) REF 44,04 (1.734) REF 71,04 (2.797) MAX 46,81 (1.843) MAX 52,45 (2.065) MAX 68,83 (2.710) MAX</p>	<p>77,8 (3.06) 36,3 (1.43) 24,5 (.96) 33,0 (1.30) 65,8 (2.59) 28,1 (1.11)</p>
DL/DLM2-96	<p>*CABLE CLAMP IN VERTICAL WIRE EXIT POSITION—EITHER END *CABLE CLAMP IN HORIZONTAL WIRE EXIT POSITION—EITHER END</p> <p>24,13 (.950) MAX 31,75 (1.250) MAX 39,29 (1.547) MAX 36,45 (1.435) MAX 30,05 (1.183) REF 44,04 (1.734) REF 71,04 (2.797) MAX 46,81 (1.843) MAX 52,45 (2.065) MAX 68,83 (2.710) MAX</p>	<p>77,8 (3.06) 36,3 (1.43) 24,5 (.96) 33,0 (1.30) 65,8 (2.59) 28,1 (1.11)</p>
DL/DLM1-156	<p>*CABLE CLAMP IN VERTICAL WIRE EXIT POSITION—EITHER END *CABLE CLAMP IN HORIZONTAL WIRE EXIT POSITION—EITHER END</p> <p>24,13 (.950) MAX 27,89 (1.098) MAX 63,50 (2.500) MAX 57,78 (2.275) MAX 43,94 (1.730) REF 50,44 (1.986) REF 86,36 (3.400) MAX 62,36 (2.455) MAX 68,58 (2.700) MAX 110,74 (4.360) MAX</p>	<p>123,4 (4.86) 36,3 (1.43) 24,5 (.96) 48,6 (1.91) 111,4 (4.38) 28,1 (1.11)</p>
DL/DLM5-260	-	<p>42,0 (1.65) 30,0 (1.18) 49,0 (1.93) 7,6 (.30) 115,8 (4.56) 42,6 (1.68)</p>
DL/DLM6-360	-	<p>42,0 (1.65) 30,0 (1.18) 63,0 (2.48) 125,0 (4.92) 42,6 (1.68)</p>

Dimensions are in mm (inches).

Assembly Instructions for Crimp Contacts

Contact Insertion:

All crimp contacts are inserted by hand. No tooling is required for either the plug or receptacle.

Caution: Do not force contacts into contact cavities. If contact encounters excessive resistance during installation remove and re-insert using a slight up and down motion. This will assure positive cavity alignment. Do not install contact if plug is in the closed or actuated position.

Plug:

Step 1 Prior to inserting contacts, turn the shaft counter-clockwise to its maximum open position.

Step 2 With the retention lance positioned away from the shaft, insert contacts from the rear of the plug.

Receptacle:

Step 1 With the retention lance positioned toward the shaft hole, insert contacts from the rear of the receptacle.

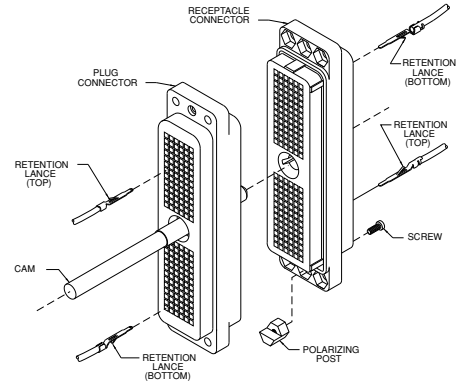

Contact Removal for Crimp Contacts

Tool: CET-DL10



Release retention lance by inserting tip of extraction tool into cavity until it bottoms on insulator shoulder. Gently pull wire in direction of arrow, see illustration, to remove contact from Insulator.

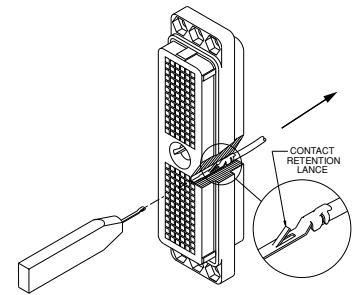

Assembly Instructions for Buss Contacts

Contact Insertion:

All buss contacts are inserted by hand. No tooling is required for either the plug or receptacle.

Caution: Do not force contacts into contact cavities. If contact encounters excessive resistance during installation remove and re-insert using a slight up and down motion. This will assure positive cavity alignment. Do not install contact if plug is in the closed or actuated position.

Plug:

Step 1 Prior to inserting contacts, turn the shaft counter-clockwise to its maximum open position.

Step 2 With the retention lance positioned away from the shaft, insert contacts from the rear of the plug.

Receptacle:

Step 1 With the retention lance positioned toward the shaft hole, insert contacts from the rear of the receptacle.

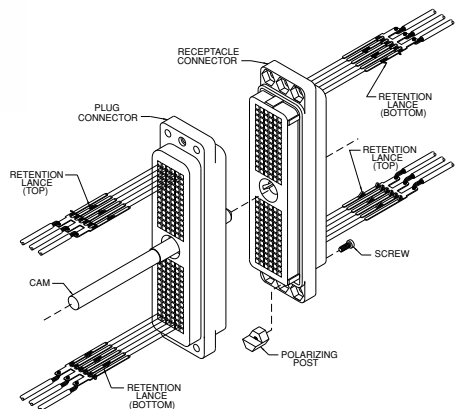

Contact Removal for Buss Contacts

Tool: CET-DL3/4/5/6



Release retention lance by inserting tip of extraction tool into cavity until it bottoms on insulator shoulder. Gently remove buss contact in direction of arrow, see illustration, to remove contact from insulator.

