

Key push button switch

Q-10446

TYPE: **A16-11ZX3**



SPECIFICATIONS

Rating	AC 250V, 3A
Contacts Resistance	10mΩ
Insulation Resistance	1000MΩ
Minimum Load	DC 500V
Dielectric Strengths	AC 1000V / 1 minute
Life Test	10 000 cycles/ minute
Material	Plastic & Metal

Outline Drawing

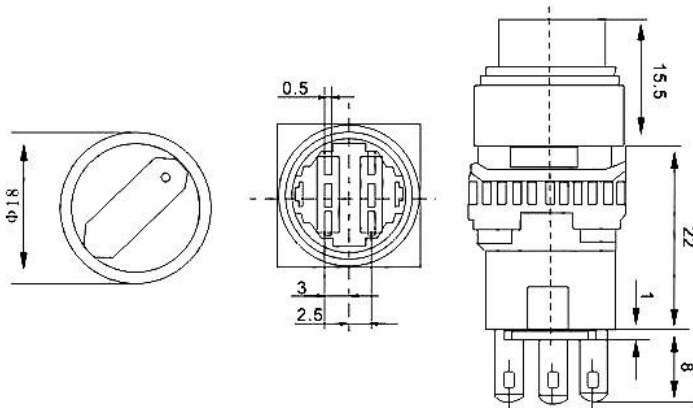

Mounting

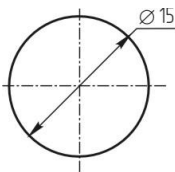

Circuitry

