

Data sheet | Item number: 2000-1403

4-conductor through terminal block; 1 mm²; suitable for Ex e II applications; side and center marking; for DIN-rail 35 x 15 and 35 x 7.5; Push-in CAGE CLAMP®; 1,00 mm²; red

www.wago.com/2000-1403

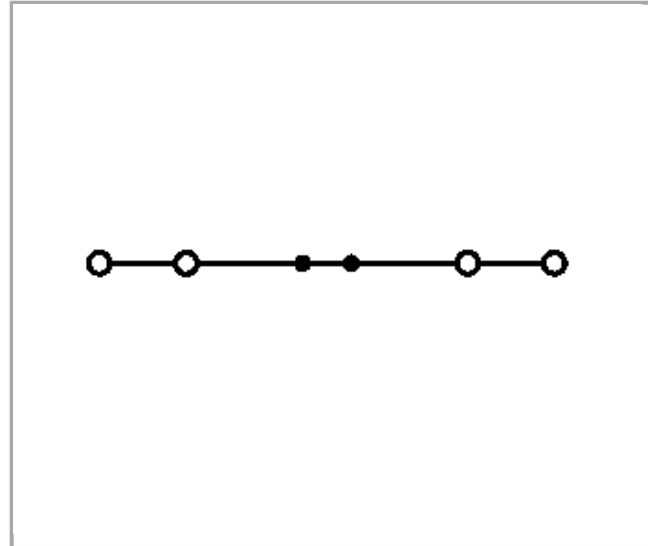
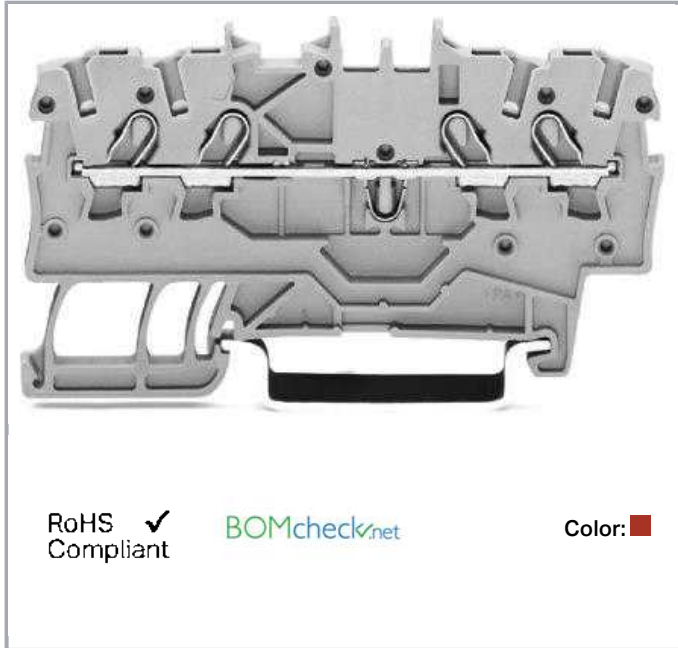

RoHS Compliant

Color:

Data

Electrical data

Ratings per IEC/EN 60664-1

Ratings per	IEC/EN 60947-7-1
Rated voltage (III / 3)	800 V
Rated impulse voltage (III / 3)	8 kV
Rated current	13.5 A
Rated current (2)	17.5 A
Legend (ratings)	(III / 3) ≙ Overvoltage category III / Pollution degree 3

Approvals per UL 1059

Rated voltage UL (Use Group B)	600 V
Rated current UL (Use Group B)	15 A
Rated voltage UL (Use Group C)	600 V
Rated current UL (Use Group C)	15 A

Subject to changes. Please also observe the further product documentation!

WAGO Kontakttechnik GmbH & Co. KG
Hansastr. 27
32423 Minden
Phone: +49571 887-0 | Fax: +49571 887-169
Email: info.de@wago.com | Web: www.wago.com

Do you have any questions about our products?
We are always happy to take your call at +49 (571) 887-44222.

Approvals per	UL 1059
---------------	---------

Approvals per CSA

Rated voltage CSA (Use Group B)	600 V
Rated current CSA (Use Group B)	10 A
Rated voltage CSA (Use Group C)	600 V
Rated current CSA (Use Group C)	10 A

Approvals Ex

Rated voltage EN (Ex e II)	550 V
Rated current (Ex e II)	13 A
Rated current (Ex e II) with jumper	12 A

Connection data

Connection technology	Push-in CAGE CLAMP®
Actuation type	Push-in Open Tool Slot
Connectable conductor materials	Copper
Nominal cross section	1 mm ²
Solid conductor	0,14 ... 1,5 mm ² / 24 ... 16 AWG
Solid conductor, push-in termination	0,5 ... 1,5 mm ² / 20 ... 16 AWG
Fine-stranded conductor	0,14 ... 1,5 mm ² / 24 ... 16 AWG
Fine-stranded conductor with ferrule with plastic collar	0,5 ... 0,75 mm ² / 20 ... 18 AWG
Fine-stranded conductor with ferrule, push-in termination, from	0,5 ... 0,75 mm ² / 20 ... 18 AWG
Strip length	9 ... 11 mm / 0.35 ... 0.43 inch
Total number of connection points	4
Total number of potentials	1
Number of levels	1
Type of wiring	Front-entry wiring
Note (conductor cross-section)	Depending on the conductor characteristic, a conductor with a smaller cross-section can also be inserted via push-in termination.
Number of jumper slots	2

Geometrical Data

Width	3,5 mm / 0.138 inch
Height from upper-edge of DIN-35 rail	32,9 mm / 1.295 inch
Depth	67,9 mm / 2.673 inch

Subject to changes. Please also observe the further product documentation!

WAGO Kontakttechnik GmbH & Co. KG
Hansastr. 27
32423 Minden
Phone: +49571 887-0 | Fax: +49571 887-169
Email: info.de@wago.com | Web: www.wago.com

Do you have any questions about our products?
We are always happy to take your call at +49 (571) 887-44222.

Mechanical data

Design	horizontal type
Type of mounting	DIN-35 rail
Marking level	Center/side marking

Material Data



Color	red
Insulating material	Polyamide 66 (PA 66)
Fire load	0.107 MJ
Weight	5.1 g

Commercial data

Product Group	22 (TOPJOB S)
Packaging type	BOX
Country of origin	CN
GTIN	4045454966942
Customs Tariff No.	85369010000

Approvals / Certificates

Ex-Approvals

Logo	Approval	Additional Approval Text	Certificate name
	AEx Underwriters Laboratories Inc.	UL 60079	E185892
	ATEX Physikalisch Technische Bundesanstalt	EN 60079	PTB 11 ATEX 1041 U (II 2 G Ex e IIC GB / I M 2 Ex e I Mb)

Country specific Approvals

Logo	Approval	Additional Approval Text	Certificate name
	CCA DEKRA Certification B.V.	EN 60947	71- 102841

Subject to changes. Please also observe the further product documentation!







CSA
DEKRA Certification B.V.

C22.2 No. 158

2130762

Ship Approvals

Logo	Approval	Additional Approval Text	Certificate name
	ABS American Bureau of Shipping	EN 60947	20- HG1941090- PDA
	BV Bureau Veritas S.A.	EN 60947	38586/A0 BV
	DNV GL Det Norske Veritas, Germanischer Lloyd	-	TAE00001V2
	LR Lloyds Register	EN 60947	91/20112 (E9)

Counterpart

Compatible products

















Carrier rail

Item no.: 210-112

















Subject to changes. Please also observe the further product documentation!

WAGO Kontakttechnik GmbH & Co. KG
Hansastr. 27
32423 Minden
Phone: +49571 887-0 | Fax: +49571 887-169
Email: info.de@wago.com | Web: www.wago.com













Do you have any questions about our products?
We are always happy to take your call at +49 (571) 887-44222.

	Steel carrier rail; 35 x 7.5 mm; 1 mm thick; 2 m long; slotted; according to EN 60715; "Hole width 25 mm	www.wago.com/210-112
	Item no.: 210-113 Steel carrier rail; 35 x 7.5 mm; 1 mm thick; 2 m long; unslotted; according to EN 60715	www.wago.com/210-113
	Item no.: 210-114 Steel carrier rail; 35 x 15 mm; 1.5 mm thick; 2 m long; unslotted; similar to EN 60715	www.wago.com/210-114
	Item no.: 210-115 Steel carrier rail; 35 x 7.5 mm; 1 mm thick; 2 m long; slotted; according to EN 60715; "Hole width 18 mm	www.wago.com/210-115
	Item no.: 210-118 Steel carrier rail; 35 x 15 mm; 2.3 mm thick; 2 m long; unslotted; according to EN 60715	www.wago.com/210-118
	Item no.: 210-196 Aluminum carrier rail; 35 x 8.2 mm; 1.6 mm thick; 2 m long; unslotted; similar to EN 60715; silver-colored	www.wago.com/210-196
	Item no.: 210-197 Steel carrier rail; 35 x 15 mm; 1.5 mm thick; 2 m long; slotted; similar to EN 60715	www.wago.com/210-197
	Item no.: 210-198 Copper carrier rail; 35 x 15 mm; 2.3 mm thick; 2 m long; unslotted; according to EN 60715; copper-colored	www.wago.com/210-198
Protective Warning Marker		
	Item no.: 2000-115 Protective warning marker; with high-voltage symbol, black; for 5 terminal blocks; yellow	www.wago.com/2000-115
Push-In type wire jumper		
	Item no.: 2009-402 Push-in type wire jumper; insulated; wire length 60 mm; Conductor cross section 0.75 mm ² ; suitable for 2000 and 2020 Series rail-mounted terminal blocks; gray	www.wago.com/2009-402
	Item no.: 2009-404 Push-in type wire jumper; insulated; wire length 110 mm; Conductor cross section 0.75 mm ² ; suitable for 2000 and 2020 Series rail-mounted terminal blocks; gray	www.wago.com/2009-404
	Item no.: 2009-406 Push-in type wire jumper; insulated; wire length 250 mm; Conductor cross section 0.75 mm ² ; suitable for 2000 and 2020 Series rail-mounted terminal blocks; gray	www.wago.com/2009-406
check		
	Item no.: 2000-510 TOPJOB®S L-type test plug module; modular; for jumper contact slot; 1,00 mm ² ; gray	www.wago.com/2000-510
	Item no.: 2000-511 TOPJOB®S L-type test plug module; modular; for jumper contact slot; 1-pole; 1,00 mm ² ; gray	www.wago.com/2000-511
	Item no.: 2000-549 Spacer module; modular; e.g., for bridging commoned terminal blocks; gray	www.wago.com/2000-549
	Item no.: 2000-552 Modular TOPJOB®S connector; modular; for jumper contact slot; 2-pole; 1,00 mm ² ; gray	www.wago.com/2000-552















Subject to changes. Please also observe the further product documentation!

	Item no.: 2000-553 Modular TOPJOB®S connector; modular; for jumper contact slot; 3-pole; 1,00 mm ² ; gray	www.wago.com/2000-553
	Item no.: 2000-554 Modular TOPJOB®S connector; modular; for jumper contact slot; 4-pole; 1,00 mm ² ; gray	www.wago.com/2000-554
	Item no.: 2000-555 Modular TOPJOB®S connector; modular; for jumper contact slot; 5-pole; 1,00 mm ² ; gray	www.wago.com/2000-555
	Item no.: 2000-556 Modular TOPJOB®S connector; modular; for jumper contact slot; 6-pole; 1,00 mm ² ; gray	www.wago.com/2000-556
	Item no.: 2000-557 Modular TOPJOB®S connector; modular; for jumper contact slot; 7-pole; 1,00 mm ² ; gray	www.wago.com/2000-557
	Item no.: 2000-558 Modular TOPJOB®S connector; modular; for jumper contact slot; 8-pole; 1,00 mm ² ; gray	www.wago.com/2000-558
	Item no.: 2000-559 Modular TOPJOB®S connector; modular; for jumper contact slot; 9-pole; 1,00 mm ² ; gray	www.wago.com/2000-559
	Item no.: 2000-560 Modular TOPJOB®S connector; modular; for jumper contact slot; 10-pole; 1,00 mm ² ; gray	www.wago.com/2000-560
	Item no.: 2009-174 Test plug adapter; for 4 mm Ø test plugs; for testing TOPJOB®S rail-mounted terminal blocks; gray	www.wago.com/2009-174
	Item no.: 2009-182 Testing tap; for max. 2.5 mm ² ; tool-free connection for individual test wires 0.08 - 2.5 mm; gray	www.wago.com/2009-182
	Item no.: 210-136 Test plug; 2 mm Ø; with 500 mm cable; red	www.wago.com/210-136
	Item no.: 210-137 Test plug; 2.3 mm Ø; with 500 mm cable; yellow	www.wago.com/210-137
Marking accessories		
	Item no.: 2009-110 Marking strips; on reel; not stretchable; plain; snap-on type; white	www.wago.com/2009-110
	Item no.: 2009-113 WMB-Inline; for Smart Printer; 2300 pieces on roll; plain; snap-on type; white	www.wago.com/2009-113
	Item no.: 2009-113/000-002 WMB-Inline; for Smart Printer; 2300 pieces on roll; plain; snap-on type; yellow	www.wago.com/2009-113/000-002
	Item no.: 2009-113/000-005 WMB-Inline; for Smart Printer; 2300 pieces on roll; plain; snap-on type; red	www.wago.com/2009-113/000-005
	Item no.: 2009-113/000-006 WMB-Inline; for Smart Printer; 2300 pieces on roll; plain; snap-on type; blue	www.wago.com/2009-113/000-006















Subject to changes. Please also observe the further product documentation!

	Item no.: 2009-113/000-007 WMB-Inline; for Smart Printer; 2300 pieces on roll; plain; snap-on type; gray	www.wago.com/2009-113/000-007
	Item no.: 2009-113/000-012 WMB-Inline; for Smart Printer; 2300 pieces on roll; plain; snap-on type; orange	www.wago.com/2009-113/000-012
	Item no.: 2009-113/000-017 WMB-Inline; for Smart Printer; 2300 pieces on roll; plain; snap-on type; light green	www.wago.com/2009-113/000-017
	Item no.: 2009-113/000-023 WMB-Inline; for Smart Printer; 2300 pieces on roll; plain; snap-on type; green	www.wago.com/2009-113/000-023
	Item no.: 2009-113/000-024 WMB-Inline; for Smart Printer; 2300 pieces on roll; plain; snap-on type; violet	www.wago.com/2009-113/000-024
	Item no.: 2009-191 Group marker carrier	www.wago.com/2009-191
	Item no.: 793-3501 WMB marking card; as card; plain; snap-on type; white	www.wago.com/793-3501
End plate		
	Item no.: 2000-1491 End and intermediate plate; 0.7 mm thick; gray	www.wago.com/2000-1491
	Item no.: 2000-1492 End and intermediate plate; 0.7 mm thick; orange	www.wago.com/2000-1492
	Item no.: 209-191 Separator for Ex e/Ex i applications; 3 mm thick; 120 mm wide; orange	www.wago.com/209-191
Jumper		
	Item no.: 2000-402 Push-in type jumper bar; insulated; 2-way; Nominal current 14 A; light gray	www.wago.com/2000-402
	Item no.: 2000-402/000-005 Push-in type jumper bar; insulated; 2-way; Nominal current 14 A; red	www.wago.com/2000-402/000-005
	Item no.: 2000-402/000-006 Push-in type jumper bar; insulated; 2-way; Nominal current 14 A; blue	www.wago.com/2000-402/000-006
	Item no.: 2000-402/000-018 Push-in type jumper bar; insulated; 2-way; Nominal current 14 A; yellow-green	www.wago.com/2000-402/000-018















Subject to changes. Please also observe the further product documentation!

		
	Item no.: 2000-403 Push-in type jumper bar; insulated; 3-way; Nominal current 14 A; light gray	www.wago.com/2000-403
	Item no.: 2000-403/000-005 Push-in type jumper bar; insulated; 3-way; Nominal current 14 A; red	www.wago.com/2000-403/000-005
	Item no.: 2000-403/000-006 Push-in type jumper bar; insulated; 3-way; Nominal current 14 A; blue	www.wago.com/2000-403/000-006
	Item no.: 2000-404 Push-in type jumper bar; insulated; 4-way; Nominal current 14 A; light gray	www.wago.com/2000-404
	Item no.: 2000-404/000-005 Push-in type jumper bar; insulated; 4-way; Nominal current 14 A; red	www.wago.com/2000-404/000-005
	Item no.: 2000-404/000-006 Push-in type jumper bar; insulated; 4-way; Nominal current 14 A; blue	www.wago.com/2000-404/000-006
	Item no.: 2000-405 Push-in type jumper bar; insulated; 5-way; Nominal current 14 A; light gray	www.wago.com/2000-405
	Item no.: 2000-405/000-005 Push-in type jumper bar; insulated; 5-way; Nominal current 14 A; red	www.wago.com/2000-405/000-005
	Item no.: 2000-405/000-006 Push-in type jumper bar; insulated; 5-way; Nominal current 14 A; blue	www.wago.com/2000-405/000-006
	Item no.: 2000-405/011-000 Star point jumper; insulated; 3-way (1-3-5); IN = IN terminal block; light gray	www.wago.com/2000-405/011-000
	Item no.: 2000-406 Push-in type jumper bar; insulated; 6-way; Nominal current 14 A; light gray	www.wago.com/2000-406
	Item no.: 2000-406/000-005 Push-in type jumper bar; insulated; 6-way; Nominal current 14 A; red	www.wago.com/2000-406/000-005
	Item no.: 2000-406/000-006 Push-in type jumper bar; insulated; 6-way; Nominal current 14 A; blue	www.wago.com/2000-406/000-006
	Item no.: 2000-406/020-000 Delta jumper; insulated; 1-2 3-4 5-6; IN = IN terminal block; light gray	www.wago.com/2000-406/020-000

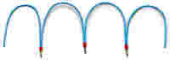
Subject to changes. Please also observe the further product documentation!

	Item no.: 2000-407 Push-in type jumper bar; insulated; 7-way; Nominal current 14 A; light gray	www.wago.com/2000-407
	Item no.: 2000-407/000-005 Push-in type jumper bar; insulated; 7-way; Nominal current 14 A; red	www.wago.com/2000-407/000-005
	Item no.: 2000-407/000-006 Push-in type jumper bar; insulated; 7-way; Nominal current 14 A; blue	www.wago.com/2000-407/000-006
	Item no.: 2000-408 Push-in type jumper bar; insulated; 8-way; Nominal current 14 A; light gray	www.wago.com/2000-408
	Item no.: 2000-408/000-005 Push-in type jumper bar; insulated; 8-way; Nominal current 14 A; red	www.wago.com/2000-408/000-005
	Item no.: 2000-408/000-006 Push-in type jumper bar; insulated; 8-way; Nominal current 14 A; blue	www.wago.com/2000-408/000-006
	Item no.: 2000-409 Push-in type jumper bar; insulated; 9-way; Nominal current 14 A; light gray	www.wago.com/2000-409
	Item no.: 2000-409/000-005 Push-in type jumper bar; insulated; 9-way; Nominal current 14 A; red	www.wago.com/2000-409/000-005
	Item no.: 2000-409/000-006 Push-in type jumper bar; insulated; 9-way; Nominal current 14 A; blue	www.wago.com/2000-409/000-006
	Item no.: 2000-410 Push-in type jumper bar; insulated; 10-way; Nominal current 14 A; light gray	www.wago.com/2000-410
	Item no.: 2000-410/000-005 Push-in type jumper bar; insulated; 10-way; Nominal current 14 A; red	www.wago.com/2000-410/000-005
	Item no.: 2000-410/000-006 Push-in type jumper bar; insulated; 10-way; Nominal current 14 A; blue	www.wago.com/2000-410/000-006
	Item no.: 2000-433 Push-in type jumper bar; insulated; from 1 to 3; Nominal current 14 A; light gray	www.wago.com/2000-433
	Item no.: 2000-433/000-005 Push-in type jumper bar; insulated; from 1 to 3; Nominal current 14 A; red	www.wago.com/2000-433/000-005

Subject to changes. Please also observe the further product documentation!

	Item no.: 2000-433/000-006 Push-in type jumper bar; insulated; from 1 to 3; Nominal current 14 A; blue	www.wago.com/2000-433/000-006
	Item no.: 2000-434 Push-in type jumper bar; insulated; from 1 to 4; Nominal current 14 A; light gray	www.wago.com/2000-434
	Item no.: 2000-435 Push-in type jumper bar; insulated; from 1 to 5; Nominal current 14 A; light gray	www.wago.com/2000-435
	Item no.: 2000-436 Push-in type jumper bar; insulated; from 1 to 6; Nominal current 14 A; light gray	www.wago.com/2000-436
	Item no.: 2000-437 Push-in type jumper bar; insulated; from 1 to 7; Nominal current 14 A; light gray	www.wago.com/2000-437
	Item no.: 2000-438 Push-in type jumper bar; insulated; from 1 to 8; Nominal current 14 A; light gray	www.wago.com/2000-438
	Item no.: 2000-439 Push-in type jumper bar; insulated; from 1 to 9; Nominal current 14 A; light gray	www.wago.com/2000-439
	Item no.: 2000-440 Push-in type jumper bar; insulated; from 1 to 10; Nominal current 14 A; light gray	www.wago.com/2000-440
	Item no.: 210-103 Wire commoning chain; insulated; 50 connections; black	www.wago.com/210-103
	Item no.: 210-123 Wire commoning chain; insulated; 50 connections	www.wago.com/210-123
ferrule		
	Item no.: 216-241 Ferrule; Sleeve for 0.5 mm ² / 20 AWG; insulated; electro-tin plated; electrolytic copper; gastight crimped; acc. to DIN 46228, Part 4/09.90; white	www.wago.com/216-241
	Item no.: 216-242 Ferrule; Sleeve for 0.75 mm ² / 18 AWG; insulated; electro-tin plated; electrolytic copper; gastight crimped; acc. to DIN 46228, Part 4/09.90; gray	www.wago.com/216-242
	Item no.: 216-243 Ferrule; Sleeve for 1 mm ² / AWG 18; insulated; electro-tin plated; electrolytic copper; gastight crimped; acc. to DIN 46228, Part 4/09.90; red	www.wago.com/216-243
tools		
	Item no.: 210-647 Operating tool; Blade: 2.5 x 0.4 mm; with a partially insulated shaft	www.wago.com/210-647
	Item no.: 210-648 Operating tool; Blade: 2.5 x 0.4 mm; with a partially insulated shaft; angled; short	www.wago.com/210-648
	Item no.: 210-719 Operating tool; Blade: 2.5 x 0.4 mm; with a partially insulated shaft	www.wago.com/210-719

Subject to changes. Please also observe the further product documentation!

Downloads Documentation

Bid Text

2000-1403 GAEB docx - Datei	Aug 7, 2018	docx 14.9 kB	Download
--------------------------------	-------------	-----------------	----------

2000-1403 GAEB X81 - Datei	Feb 19, 2019	xml 4.0 kB	Download
-------------------------------	--------------	---------------	----------

Additional Information

Technical explanations	Apr 3, 2019	pdf 2.1 MB	Download
------------------------	-------------	---------------	----------

CAD/CAE-Data

CAD data

2D/3D Models 2000-1403	URL	Download
------------------------	-----	----------

CAE data

EPLAN Data Portal 2000-1403	URL	Download
-----------------------------	-----	----------

WSCAD Universe 2000-1403	URL	Download
--------------------------	-----	----------

Installation Notes

Conductor termination

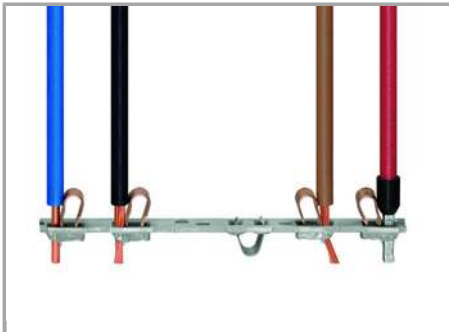

All conductor types at a glance

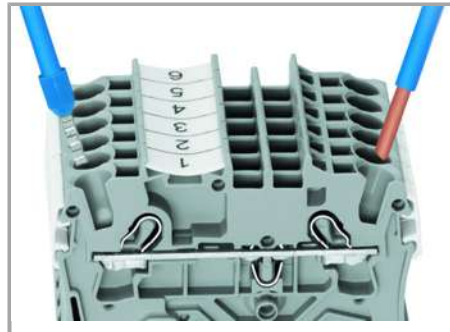

Terminating solid and ferruled conductors via push-in connection.

Subject to changes. Please also observe the further product documentation!

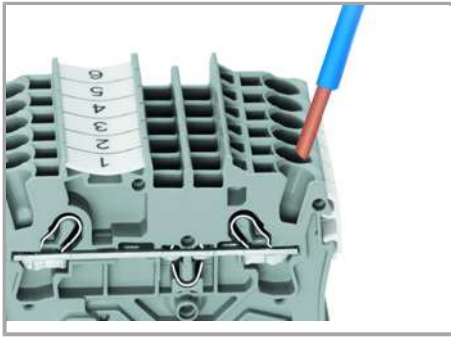

Inserting conductors via push-in termination.

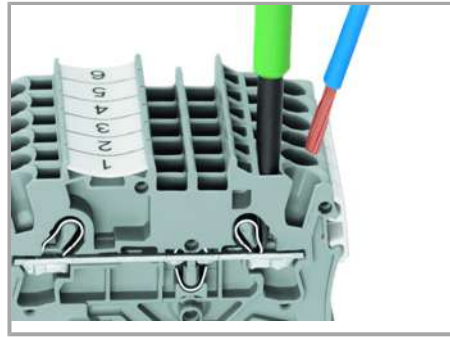

Inserting a conductor via operating tool.

Solid conductors with cross-sections from either one size above, or up to two sizes below, the rated cross-section can be simply pushed in – no tools needed.

Connecting fine-stranded conductors without ferrules, or small cross-sectional conductors that cannot be pushed in, is performed similarly to the original CAGE CLAMP® – just use an operating tool.

The smart feature:

To open the clamp, the operating tool is inserted vertically. The conductor entry is less than 15 degrees for easier wiring.

Commoning

Subject to changes. Please also observe the further product documentation!

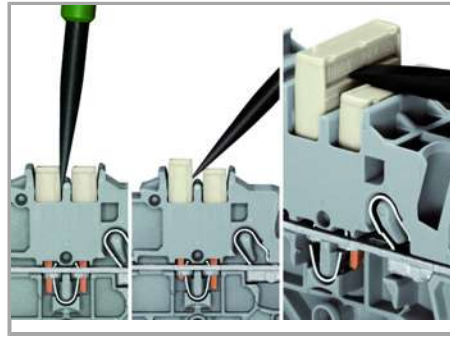
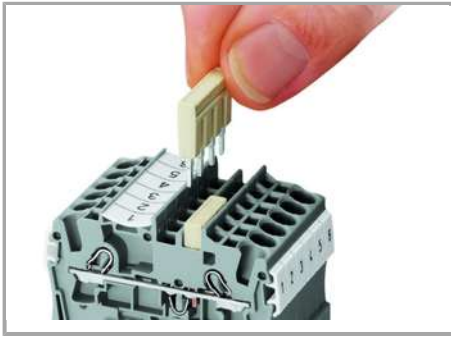

The push-in type jumper bar system is based on the common plug and socket principle. Each terminal block is spring-loaded with a double socket and a resilient CrNi steel spring. The jumper contact material is pure electrolytic copper, which allows for an extremely small design capable of carrying the full-rated current of the terminal block. Ground terminal blocks can also be commoned using the same jumper system. Custom jumpers are created by breaking and removing jumper contacts (2000, 2001, 2002, 2004 Series).

Removing a push-in type jumper bar.

Insert the operating tool between the jumper and and partition wall of the dual jumper slots, then lift up the jumper.

Place the operating tool in the center of jumpers up to five contacts (see above), or alternately on both sides for jumpers with more than five contacts.

Commoning

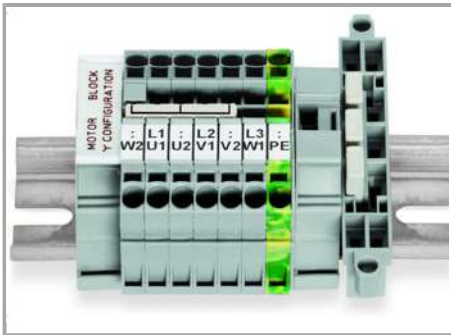

This star point jumper has been specially developed to create a "star point" and is used on motor terminal boards equipped with TOPJOB® S rail-mount terminal blocks.



This delta jumper has been specially developed to create a delta configuration and is used on motor terminal boards equipped with TOPJOB® S rail-mount terminal blocks.



Push down the wire jumper (2009-402) until fully inserted. Lift the jumper with an operating tool for rewiring.

Testing

Subject to changes. Please also observe the further product documentation!



The modular TOPJOB® S connectors also connect conductors of the same size as the terminal blocks being used.



TOPJOB® S Connectors with a 2 mm Ø test socket for testing voltage via 2-pole voltage tester

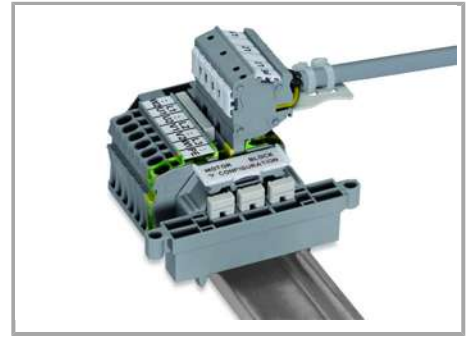

Rail-mount terminal block assembly for electric motor wiring



Test plug adapter (2009-174, CAT II) for 4 mm Ø plugs – compatible with 2000 to 2016 Series

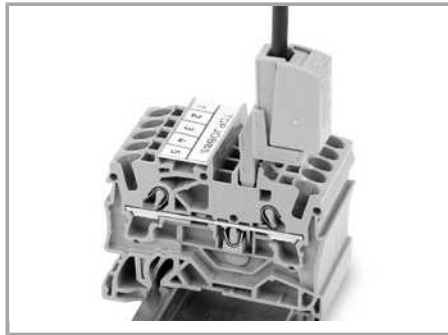

Testing tap (2009-182) for tool-free connection of test cables up to 2.5 mm² (12 AWG) – compatible with 2000 to 2016 Series

Marking

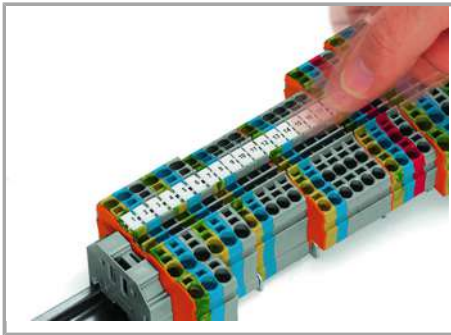

Snapping WMB Inline markers into marker slots.

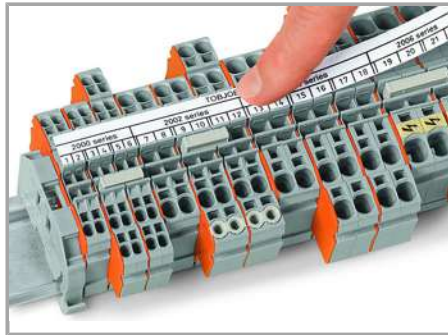

Subject to changes. Please also observe the further product documentation!

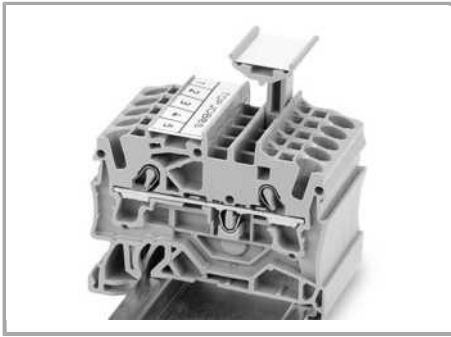

TOPJOB® S 2009-193 Group Marker Carrier (equipped with a marking strip) for all 2001 to 2016 Series TOPJOB® S Rail-Mount Terminal Blocks

Do not use on an end plate!

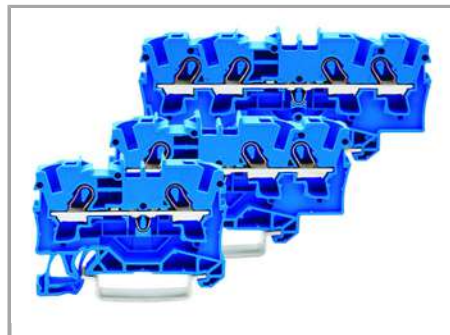

Through terminal blocks with a blue insulated housing are suitable for Ex i applications.



All through and ground conductor terminal blocks are suitable for Ex e II applications.

Subject to changes. Please also observe the further product documentation!

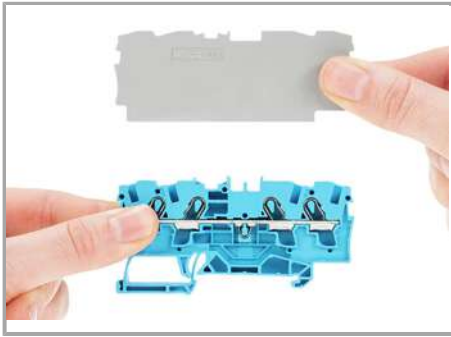

Separator for Ex e/Ex applications

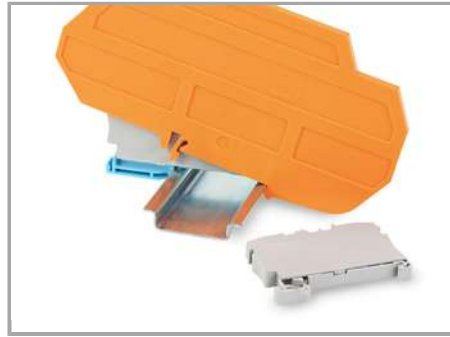

Ex e II/Ex i terminal strip

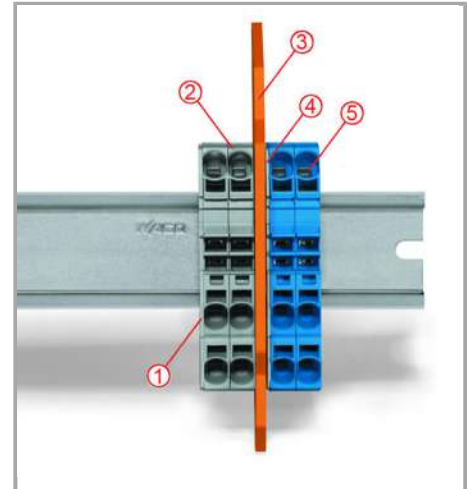

Separator located between Ex e II and Ex i terminal strip

An end plate must be applied to the terminal block located directly behind an Ex e/Ex i separator plate.

Notice:

The movable feet of terminal blocks and separator plates must face the same direction.

End plate

Ex e II terminal blocks

Separator for Ex e/Ex i applications

End plate

Ex i terminal blocks

According to EN 50020, a minimum distance of 50 mm must be kept between live parts of Ex e and Ex i circuits. The use of Ex e/Ex i separators is a space-saving solution when Ex e and Ex i terminal blocks are mounted on a common carrier rail.

Product family

TOPJOB® S

Subject to changes. Please also observe the further product documentation!



TOPJOB® S: In various industrial applications and modern building installations, WAGO's wide and versatile range of rail-mount terminal blocks provides more than just reliable electrical connections.

[Show all products from the family](#)

Subject to changes. Please also observe the further product documentation!

WAGO Kontakttechnik GmbH & Co. KG
Hansastr. 27
32423 Minden
Phone: +49571 887-0 | Fax: +49571 887-169
Email: info.de@wago.com | Web: www.wago.com

Do you have any questions about our products?
We are always happy to take your call at +49 (571) 887-44222.