

easy / easy compact / easy split
electronic digital thermostats with defrost control

CAREL



ENG User manual

**LEGGI E CONSERVA
QUESTE ISTRUZIONI**
**READ AND SAVE
THESE INSTRUCTIONS**

  **NO POWER
& SIGNAL
CABLES
TOGETHER**
READ CAREFULLY IN THE TEXT!

Integrated Control Solutions & Energy Savings

WARNINGS



CAREL bases the development of its products on decades of experience in HVAC, on the continuous investments in technological innovations to products, procedures and strict quality processes with in-circuit and functional testing on 100% of its products, and on the most innovative production technology available on the market. CAREL and its subsidiaries nonetheless cannot guarantee that all the aspects of the product and the software included with the product respond to the requirements of the final application, despite the product being developed according to start-of-the-art techniques. The customer (manufacturer, developer or installer of the final equipment) accepts all liability and risk relating to the configuration of the product in order to reach the expected results in relation to the specific final installation and/or equipment. CAREL may, based on specific agreements, act as a consultant for the positive commissioning of the final unit/application, however in no case does it accept liability for the correct operation of the final equipment/system.

The CAREL product is a state-of-the-art device, whose operation is specified in the technical documentation supplied with the product or can be downloaded, even prior to purchase, from the website www.carel.com.

Each CAREL product, in relation to its advanced level of technology, requires setup/configuration/programming/commissioning to be able to operate in the best possible way for the specific application. The failure to complete such operations, which are required/indicated in the user manual, may cause the final product to malfunction; CAREL accepts no liability in such cases.

Only qualified personnel may install or carry out technical service on the product.

The customer must only use the product in the manner described in the documentation relating to the product.

In addition to observing any further warnings described in this manual, the following warnings must be heeded for all CAREL products

- prevent the electronic circuits from getting wet. Rain, humidity and all types of liquids or condensate contain corrosive minerals that may damage the electronic circuits. In any case, the product should be used or stored in environments that comply with the temperature and humidity limits specified in the manual.
- do not install the device in particularly hot environments. Too high temperatures may reduce the life of electronic devices, damage them and deform or melt the plastic parts. In any case, the product should be used or stored in environments that comply with the temperature and humidity limits specified in the manual.
- do not attempt to open the device in any way other than described in the manual.
- do not drop, hit or shake the device, as the internal circuits and mechanisms may be irreparably damaged.
- do not use corrosive chemicals, solvents or aggressive detergents to clean the device.
- do not use the product for applications other than those specified in the technical manual.

All of the above suggestions likewise apply to the controllers, serial boards, programming keys or any other accessory in the CAREL product portfolio.

CAREL adopts a policy of continual development. Consequently, CAREL reserves the right to make changes and improvements to any product described in this document without prior warning.

The technical specifications shown in the manual may be changed without prior warning.

The liability of CAREL in relation to its products is specified in the CAREL general contract conditions, available on the website www.carel.com and/or by specific agreements with customers; specifically, to the extent where allowed by applicable legislation, in no case will CAREL, its employees or subsidiaries be liable for any lost earnings or sales, losses of data and information, costs of replacement goods or services, damage to things or people, downtime or any direct, indirect, incidental, actual, punitive, exemplary, special or consequential damage of any kind whatsoever, whether contractual, extra-contractual or due to negligence, or any other liabilities deriving from the installation, use or impossibility to use the product, even if CAREL or its subsidiaries are warned of the possibility of such damage.

WARNINGS



Separate as much as possible the probe and digital input signal cables from the cables carrying inductive loads and power cables to avoid possible electromagnetic disturbance.

Never run power cables (including the electrical panel wiring) and signal cables in the same conduits.

DISPOSAL



The product is made up of metal parts and plastic parts. In reference to European Union directive 2002/96/EC issued on 27 January 2003 and the related national legislation, please note that:

1. WEEE cannot be disposed of as municipal waste and such waste must be collected and disposed of separately;
2. the public or private waste collection systems defined by local legislation must be used. In addition, the equipment can be returned to the distributor at the end of its working life when buying new equipment;
3. the equipment may contain hazardous substances: the improper use or incorrect disposal of such may have negative effects on human health and on the environment;
4. the symbol (crossed-out wheeled bin) shown on the product or on the packaging and on the instruction sheet indicates that the equipment has been introduced onto the market after 13 August 2005 and that it must be disposed of separately;
5. in the event of illegal disposal of electrical and electronic waste, the penalties are specified by local waste disposal legislation.

Content

1. INTRODUCTION	7
1.1 Main characteristics	7
1.2 Models	7
1.3 Main differences between easy, easy compact and easy split	9
1.4 NTC and PTC probes	9
1.5 Accessories.....	9
1.6 Definitions.....	9
2. ASSEMBLY AND INSTALLATION	10
2.1 Assembly	10
2.2 Electrical connections	11
2.3 Wiring diagram for multiple units	13
3. USER INTERFACE AND START UP	14
3.1 easy	14
3.2 easy compact	14
3.3 easy split	15
3.4 Preliminary configurations	15
3.5 Functions available from the keypad.....	15
4. FUNCTIONS AND PARAMETERS	17
4.1 Temperature probe settings.....	17
4.2 Temperature display.....	17
4.3 Temperature control	18
4.4 Duty Setting	18
4.5 Continuous cycle	19
4.6 Compressor protection	19
4.7 Defrost	20
4.8 Alarm parameters	22
4.9 Door open/closed management.....	25
4.10 Evaporator fan management parameters.....	27
4.11 Clock and time band parameters.....	28
4.12 Rapid parameter set selection (EZY).....	29
4.13 Other settings	29
5. TABLES OF ALARMS AND PARAMETERS	31
5.1 Table of alarms and signals.....	31
5.2 Description of the main signals and alarms.....	31
5.3 Data error	32
5.4 Modifying the parameters.....	32
5.5 Setting the default parameters.....	32
5.6 Table of easy parameters.....	33
5.7 Table of easy compact parameters.....	34
5.8 Table of easy split parameters	35
5.9 Table of EZY parameter sets	36
5.10 Troubleshooting.....	38
6. TECHNICAL SPECIFICATIONS	39
6.1 easy technical specifications	39
6.2 easy compact technical specifications.....	39
6.3 easy split technical specifications	40
6.4 Electromagnetic compatibility.....	41

1. INTRODUCTION

easy, easy compact and easy split are electronic microprocessor controllers with LED display, developed for the management of refrigerating units, display cabinets and showcases. They exploit the experience and the success of the previous PJ32 range, with the objective of offering a product that is simpler and more economical. The structure of the parameters has been enhanced with new functions for more

dynamic and effective management of the temperature control and defrost.

easy compact the smallest, most economical easy model, with one relay only, and a simplified display.

easy split model with separate terminal and power board.

1.1 Main characteristics

The following table lists the main features of the easy, easy compact and easy split controllers.

Features	Models		
	easy	easy compact	easy split
Ergonomic polycarbonate keypad with three buttons	✓	✓	✓
Keypad protection to prevent tampering	✓	✓	✓
Access to the configuration parameters by password	✓	✓	✓
Digit display	-199...999	-99...99	-199...999
Decimal point	✓	✓	✓
Display in °C or °F	✓	✓	✓
LED display			
Defrost (*)			
- by stopping the compressor	✓	✓	✓
- heater	✓	-	✓
- hot gas	✓	-	✓
- heater with temperature control	✓	-	✓
Duty setting function	✓	✓	✓
Continuous cycle function	✓	✓	✓
Relay outputs (*)			
Up to two analogue inputs for NTC or PTC probes (*)	✓	✓	-
Up to two analogue inputs for NTC/NTC-HT probes	-	-	✓
Multifunction analogue or digital input (*)	✓	-	✓
In the models with at least 2 probes: display second/third probe (*)	✓	✓	✓
Input for CAREL IROPZKEY** programming key (*)	✓	✓	✓
Input for external CAREL IROPZ485 connector (RS485 network) (*)	✓	✓	✓
Buzzer (audible alarm signals) (*)	✓	-	✓
Fixed or removable terminals	✓	✓	-
Fastening from rear or front	✓	✓	✓
Easy Set (rapid instrument configuration selection)	✓	✓	✓

Table 1.a

(*) Check that this is available on the model in question.



Important: each of the features should be checked for the model in question.

1.2 Models

The easy and easy compact controllers differ as regards operation, and the number inputs and outputs. easy split models feature a separate terminal and power board.

easy models:

PJEZS (0, 1, 6, 7)*; PJEZ(X, Y)*; PJEZC* controllers and PJEZM(0, 1, 6, 7)* thermometer only

easy compact models:

PJEZS(N, P)* controller and PJEZM(N,P)* thermometer only

easy split models:

PJEZ*8**** controllers with one relay used for the light output.

Models and features

S models (PJEZS*)

The ideal solution for the management of static refrigeration units (that is, without fan on the evaporator), operating at normal temperature (above 0 °C). This model, in fact, performs the functions of thermometer, displaying the temperature of the unit, and electronic thermostat, activating the compressor (or the solenoid valve in the case of multiplexed units) so as to maintain the required temperature. In addition, it features compressor protection algorithms and automatic defrost function by shutting down the compressor.

X and Y models (PJEZX*, PJEZY*)

These are designed for the management of static units operating at low temperature (that is, below 0°C), which require active defrost using electric heaters or the injection of hot gas. The PJEZ(Y,X)*, in fact, as well as working as a thermometer and a thermostat (like the PJEZS), also manages the defrost actuator. The frequency and duration of the defrost can be set. The end defrost can occur according to the temperature reached (connecting a probe to the evaporator) or by time. In addition these models feature two probe inputs, for the control probe (room), the defrost probe, and a digital input (this can also be configured as a probe). There are two outputs, for controlling the actuator (compressor \ominus) and the defrost \otimes . Models PJEZY and PJEZX differ in that:

- PJEZY has relays that are electrically connected together;
- PJEZX has independent relays.

C models (PJEZC*)

The most complete solution for low temperature ventilated units, with three relays for complete control of the compressor, fan and defrost functions. The three relays are included in the very compact case in the versions with 230 V or 115 V power transformer, without compromising the performance or reliability of the product.

M models (PJEZM*)

Solution for simply measuring the temperature.

Summary table of the functions associated with the models

function	see par.	easy						easy compact				easy split		
		mod. C	mod. X	mod. Y	mod.S		mod.M		mod.S		mod.M		mod. S	mod. C
					2 probes + multifun. input	1 probe	2 probes + multifun. input	1 probe	2 prbs	1 probe	2 prbs	1 probe		
temperature display	4.2	✓	✓	✓	✓	✓	✓	✓	✓	✓	✓	✓	✓	✓
temperature measurement in °C/°F	4.2	✓	✓	✓	✓	✓	✓	*	✓	✓	✓	*	✓	✓
parameter access using password	5.4	✓	✓	✓	✓	✓	✓	*	✓	✓	✓	*	✓	✓
set point modification	3.5	✓	✓	✓	✓	✓	✓	*	✓	✓	✓	*	✓	✓
night-time set point management	4.3	✓	✓	✓	✓	-	✓	-	-	-	-	-	✓	✓
enable/disable direct probe 2 alarm	4.2	-	-	-	-	-	✓	-	-	-	✓	-	-	-
temperature probe calibration	4.1	✓	✓	✓	✓	✓	✓	*	✓	✓	✓	*	✓	✓
temperature control in DIRECT mode	4.3	✓	✓	✓	✓	✓	-	-	✓	✓	-	-	✓	✓
temperature control in REVERSE mode	4.3	✓	✓	✓	✓	✓	-	-	✓	✓	-	-	✓	✓
compressor protectors	4.6	✓	✓	✓	✓	✓	-	-	✓	✓	-	-	✓	✓
duty setting	4.4	✓	✓	✓	✓	✓	-	-	✓	✓	-	-	✓	✓
continuous cycle	4.5	✓	✓	✓	✓	✓	-	-	✓	✓	-	-	✓	✓
defrost	4.7	✓	✓	✓	✓	✓	-	-	✓	✓	-	-	✓	✓
high/low temperature alarm	4.8	✓	✓	✓	✓	✓	✓	*	✓	✓	✓	*	✓	✓
dirty condenser alarm	4.8	✓	✓	✓	✓	✓	-	✓	-	✓	-	-	✓	✓
evaporator fan management	4.10	✓	-	-	-	-	-	-	-	-	-	-	-	✓
ON/OFF	3.5	✓	✓	✓	✓	✓	✓	*	✓	✓	✓	*	✓	✓
AUX output configuration	4.13	✓	✓	✓	✓	✓	✓	*	✓	✓	✓	*	✓	✓
enable/disable keypad	4.13	✓	✓	✓	✓	✓	✓	*	✓	✓	✓	*	✓	✓
enable/disable buzzer	4.13	✓	✓	✓	✓	✓	✓	*	-	-	-	-	✓	✓
modified parameter detection	4.13	✓	✓	✓	✓	✓	✓	*	✓	✓	✓	*	✓	✓
rapid parameter set selection	4.12	✓	✓	✓	✓	✓	-	-	✓	✓	-	-	✓	✓
clock and time band management	4.11	✓	✓	✓	-	-	-	-	-	-	-	-	✓	✓
door switch with light management	4.8	-	-	-	-	-	-	-	-	-	-	-	✓	✓
disable high temperature alarm when starting	5.1	-	-	-	-	-	-	-	-	-	-	-	✓	✓
second compressor output in parallel	4.13	-	-	-	-	-	-	-	-	-	-	-	✓	✓
second comp. output with two step control with or without rotation	4.13	-	-	-	-	-	-	-	-	-	-	-	✓	✓
fan management with comp. off	4.10	-	-	-	-	-	-	-	-	-	-	-	-	✓
night-time operation with light management	4.11	-	-	-	-	-	-	-	-	-	-	-	✓	✓

Table 1.b

* available but cannot be set from the keypad nor the programming key.

1.3 Main differences between easy, easy compact and easy split

Unlike the easy and easy compact models, the easy split models feature a separate terminal and power board. There are also other differences, such as the auxiliary multifunction relay for managing the light output or a second compressor, and new software functions. The table below highlights the differences and indicates the page showing the related explanation.

topic	easy, easy compact	easy split	easy split parameter	page
type of probes connectable (selectable by parameter, easy split only)	NTC, PTC	NTC, NTC-HT	/P	9
dedicated relay for the light output	NO	YES	H1=4	29
light on/off from the keypad	defrost only	YES	H1=4	16
probe display rate function	NO	YES	/3	17
curtain switch (night-time operation) with light management	NO	YES	A4=4	24
light not managed/ managed with door switch and evaporator fan off	NO	YES	A4=7, 10	25
light not managed/ managed with door switch and evaporator fan and compressor off	NO	YES	A4=8, 11	25
door open/closed management	NO	YES	Ado	25
second compressor output in parallel with dedicated relay	NO	YES	H1=5	29
second compressor output with two step control with or without rotation	NO	YES	H1=7/6	29
second compressor delay	NO	YES	c11	19
fan management with compressor off	NO	YES	F2=2, F4, F5	27
night-time operation with light management	NO	YES	A4=4, H1=4	24
year, month, day of month setting	NO	YES	YEr, MOm, dMO	28
disable high temperature alarm when starting	NO	YES	-	31
maintenance request signal (SrC)	NO	YES	HMP, HMd, HMm	30

Table 1.c

1.4 NTC and PTC probes

All easy and easy compact models use PTC and NTC probes conforming to the CAREL standard, with resistance values of 985Ω at 25°C for the PTC, and 10 kΩ for the NTC. The type of probe installable depends on the model (order code). The easy split models, on the other hand, only use NTC and high temperature NTC probes (50 kΩ at 25°C), selected by parameter. Below are some codes of the more common CAREL.

code	description	operating range	index of protection
NTC***HP00	NTC probe, 6x15 mm bulb, plastic	-50T50°C	IP67
NTC***HT00	High temp. NTC probe, 5x20 bulb mm, polyester	0T120 °C (max 150 °C for 3000 h)	IP55
NTC***WP00	NTC probe, 6x40 mm bulb, metal	-50T100°C	IP67
PTC***W000	PTC probe, 6x40 mm bulb, metal, 1.5 m long	-50T100°C	IP67

Table 1.d

1.5 Accessories

- CAREL IROPZKEY* programming key (for duplicating the parameters);
- CAREL IROPZ485S0 RS485 converter (for the RS485 supervisory network).
- CAREL USB/RS485 converter CVSTDUMOR0 to interface a RS485 network to a personal computer via the USB port;
- VPM, program downloadable from <http://ksa.carel.com>. This tool, running on a computer, can be used to commission the controller, program the parameters and update the firmware;
- COM TOOL, program downloadable from <http://ksa.carel.com>. This tool can be used to program the controller from any PC, save the different configurations in files that can be recalled during final programming, create custom sets of parameters for rapid programming and configure the different users with password protected access profiles. Connection to the PC requires the USB/RS485 converter code CVSTDUMOR0;

- connection cable between terminal and power board (easy split only). Available in different lengths (PEOPZC1500=1.5 m, PEOPZC3000=3.0 m, PEOPZC5000=5.0 m).

1.6 Definitions

Continuous cycle: function that runs the compressor for the set time.

Defrost: function that controls the defrost of the evaporator.

Duty setting: safety function that in the event of control probe faults starts the compressor at set time intervals.

easy: trademark of the PJEZ(S, X, Y, C, M)* thermostats.

easy compact: more compact and economical version of the easy. Available in models PJEZ(S, M)*.

easy split: version with separate terminal and power board. Versions available with (PJEZ*8R***) or without (PJEZ*8I***) RTC, and the power board can be supplied with (PJEZ*8**5*) or without (PJEZ*8**4*) plastic case.

2. ASSEMBLY AND INSTALLATION

2.1 Assembly



Warnings:

Avoid installing the boards in environments with the following characteristics:

- relative humidity greater than 90% or where there is condensation;
- strong vibrations or knocks;
- exposure to continuous water sprays;
- exposure to aggressive and polluting atmospheres (e.g.: sulphur and ammonia fumes, saline mist, smoke) so as to avoid corrosion and/or oxidation;
- strong magnetic and/or radio frequency interference (there avoid installing the units near transmitting antennae);
- near transmitting antennae and to the elements in general;
- large and rapid fluctuations in the ambient temperature;
- environments where explosives or mixes of flammable gases are present;
- exposure to dust (formation of corrosive patina with possible oxidation and reduction of insulation).

To install easy, easy compact and easy split: make an opening in the panel based on the drilling template, 71x29 mm.

Panel installation using 2 rear brackets (Figs. 2.a and 2.b)

- insert the instrument in the opening (phase 1);
- secure the instrument by sliding the brackets in the guides on the instrument until compressing them against the panel (phase 2);

easy

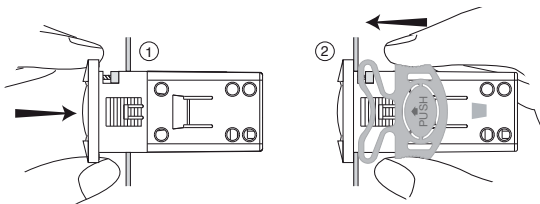

Fig. 2.a

easy compact, easy split

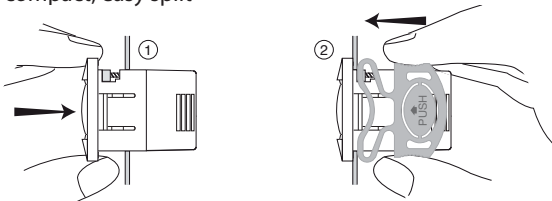

Fig. 2.b

Removing from the panel with brackets

- release the instrument by pressing both brackets where marked "push" and sliding it back on the guides.

Panel installation from the front using screws (Fig. 2.c)

- the thickness of the fastening panel must not exceed 3 mm;
- remove the front frame and make sure that the two catches are in place (these must not protrude from the outline of the drilling template). If necessary, unscrew the two screws. Do not unscrew excessively, the screws must not be detached from the front panel (phase 1);
- insert the instrument in the opening in the panel and hold it in position by the centre of the front panel (phase 1);
- using the screwdriver, tighten the bottom screw 90°, the catch must come out of its slot and click onto the panel, then tighten until the front panel is secure. Do not over-tighten, when the front panel is secured blocks simply make another 1/2 turn to compress the gasket; If the catch does not click onto the panel, unscrew the screw, applying pressure at

the same time with the screwdriver so that the catch moves back. Do not unscrew too much, the head of the screw must not be raised from the surface of the front panel (phase 2);

- repeat the same operation for the top screw (phase 2);
- apply the front frame (phase 3).

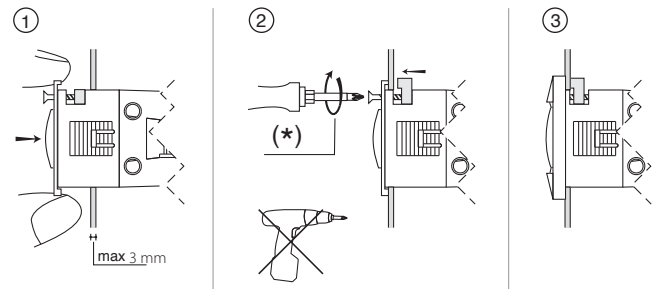

Fig. 2.c

(*) do not over-tighten the screws.

Dismantling using the screws from the front

- unclip the front frame;
- unscrew the bottom screw, at the moment the front panel detaches from the panel keep pressure on the screw and unscrew a further 90° to make the catch go back into its slot;
- repeat for the top screw;
- remove the instrument from panel, keeping it horizontal

easy split: power board dimensions and assembly

Assembly is performed using plastic spacers or plastic turrets. The power board is supplied upon fitted in a standard case for panel mounting, dimensions 190x140x70.

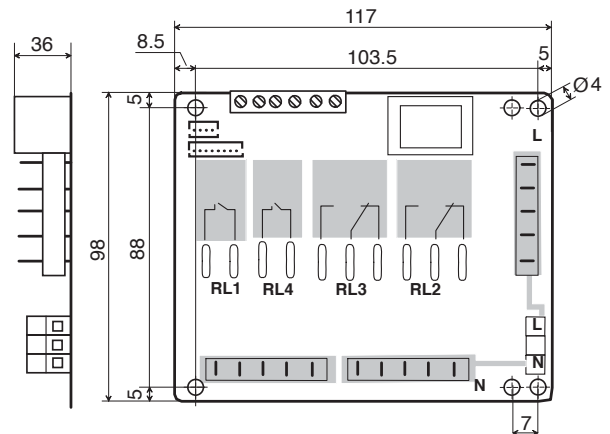

Fig. 2.d



Warnings:

- the connection cables must guarantee insulation at least up to 90 °C;
- spade terminals with max. operating temperature at least 100°C
- if the board is installed in an electrical panel with metal cabinet, allow at least 10 mm distance between the cabinet and any point on the board (rear, edges and assembly holes);
- the probe and digital input connections must be less than 10 m long, adopt suitable measures to separate the cables for compliance with immunity standards;
- suitably fasten the output connection cables to avoid contact with extra low voltage components.

2.2 Electrical connections

Warnings:

- the electrical connections must only be completed by a qualified electrician;
- a power supply other than the type specified may seriously damage the system;
- on easy split models supplied with plastic case, given the high maximum power supply current (16 A), the unit may heat up: in this case, make sure the maximum temperature allowed is not exceeded. See the table of technical specifications;
- separate as much as possible the probes and digital input signal cables from the cables carrying inductive loads and power cables to avoid possible electromagnetic disturbance. Never lay power cables (including the electrical cables) and probe signal cables in the same conduits. Do not install the probe cables in the immediate vicinity of power devices (contactors, circuit breakers or similar);
- reduce the path of the probe and sensor cables as much as possible, and avoid spiral paths that enclose power devices. The probes must be connected using shielded cables (minimum cross-section of each wire: 0.5 mm²);
- avoid direct contact with internal electronic components;
- connection errors (and connections other than those indicated in this manual) may involve danger to the safety of the users and cause faults on the instruments and the components connected;
- fit the unit with all the electromechanical safety devices required to guarantee correct operation and the complete safety of the user.

Information:

- the probes can be installed up to a maximum distance of 30 m from the controller (10 m for easy split). To extend the distance of the probes, use cables with a minimum cross-section of 1 mm², shielded where possible. In this case, the shield must be connected to the common of the probe. Do not earth the other end of the shield (the sensor end);
- only use IP67 probes as end defrost probes; place the probes with the vertical bulb upwards, so as to assist the drainage of any condensate. The thermistor temperature probes (NTC or PTC) have no polarity, so the order of connection of the ends is not important;
- use cable ends suitable for the corresponding terminals. Loosen each screw and insert the cable ends, then tighten the screws. When the operation is completed, slightly tug the cables to check they are sufficiently tight.

The connections of the inputs and outputs, depending on the models, may be made:

- using traditional screw terminals;
- using plug-in terminals with screw cable connection blocks;
- using plug-in terminals with crimped cable connection blocks.
- using plug-in terminals, which significantly simplify the connection of the instrument both during installation and maintenance. This also avoids connection errors, as there are three connection blocks with a different number of pins.

Connect the inputs and the outputs following the diagram shown on the instrument label.

For the 12 Vac versions:

- if the power supply available is mains, a safety transformer is required to ensure double insulation between the power supply and the very low voltage electronics. If required, a fuse must be installed in series with the primary (32 mA for code TRA12VDE00). The transformer-instrument connection must be as short as possible;
- if the power supply available is already low voltage, but not 12 Vac, a suitable adapting transformer must be used: double insulation between the primary and secondary and definition for surge on the primary to the appropriate level (2000 V for applications in industrial environments).
- as double insulation cannot be guaranteed between the power supply connectors and the relay outputs, only use loads powered at safety extra low voltage (effective rating up to 42 V).

The voltage supplied to these terminals (see the wiring diagrams) must correspond, within the specified tolerances, to the value shown on the instrument connection label. The insulation of the instrument, for versions with mains power supply (230 Vac and 115 Vac), is reinforced. The versions with 12 Vac/Vdc power supply, on the other hand, do not feature such insulation.

For easy split:

Refer to the following wiring diagram;

- power supply L, N, PE: use cables with a suitable cross-section for the load (2.5 mm² for current ratings up to 16 A and 4 mm² for current ratings up to 24 A);
- load connection: terminate with 6.3 mm female spade contacts, cable cross-section 2.5 mm² for current ratings up to 16 A;
- use:
 - cables with max. operating temperature at least 90 °C
 - spade terminals with max. operating temperature at least 100 °C
- internal jumpers for power supply to loads as per the previous point;
- probe and digital input connections with 0.5 to 1.5 mm² cables;
- terminal connection using specified cables.

easy wiring diagrams

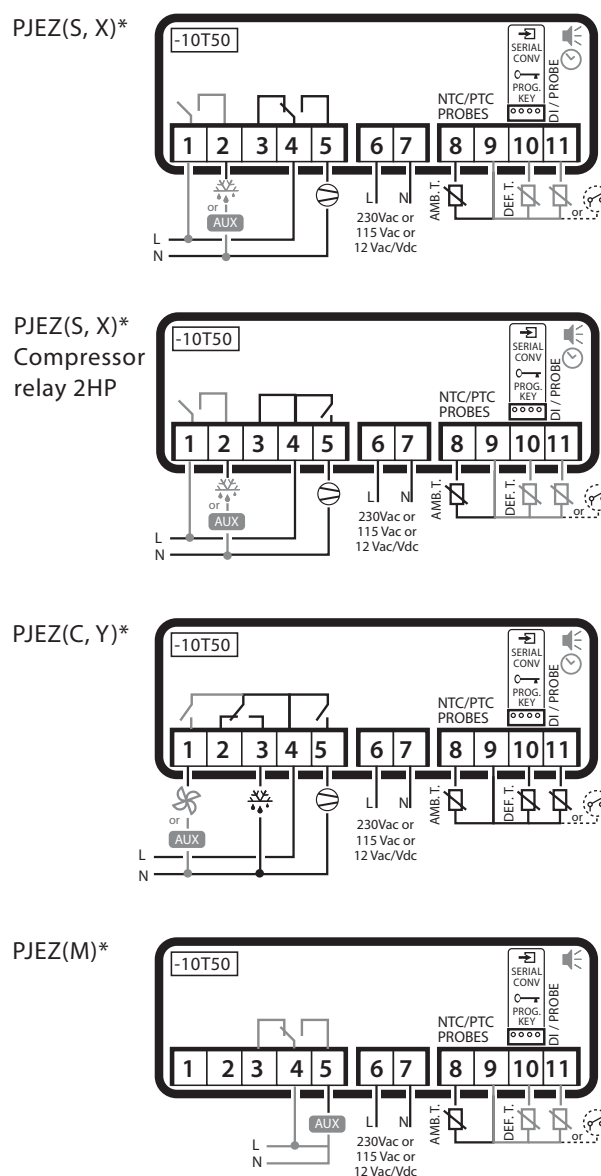
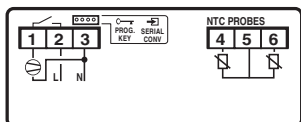

Fig. 2.e

easy compact wiring diagrams

PJEZS**0**
PJEZS**1**



PJEZS***E**

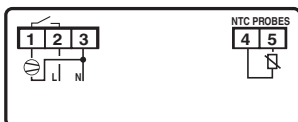

PJEZM*N*0**
PJEZM*N*1**

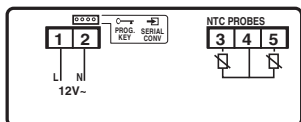

PJEZM*N*E**

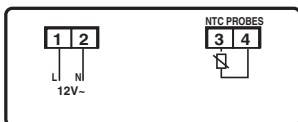

PJEZM*P*0**
PJEZM*P*1**

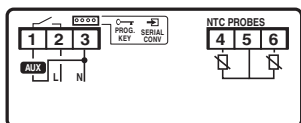

PJEZM*P*E**

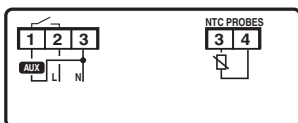

Fig. 2.f

easy split wiring diagram

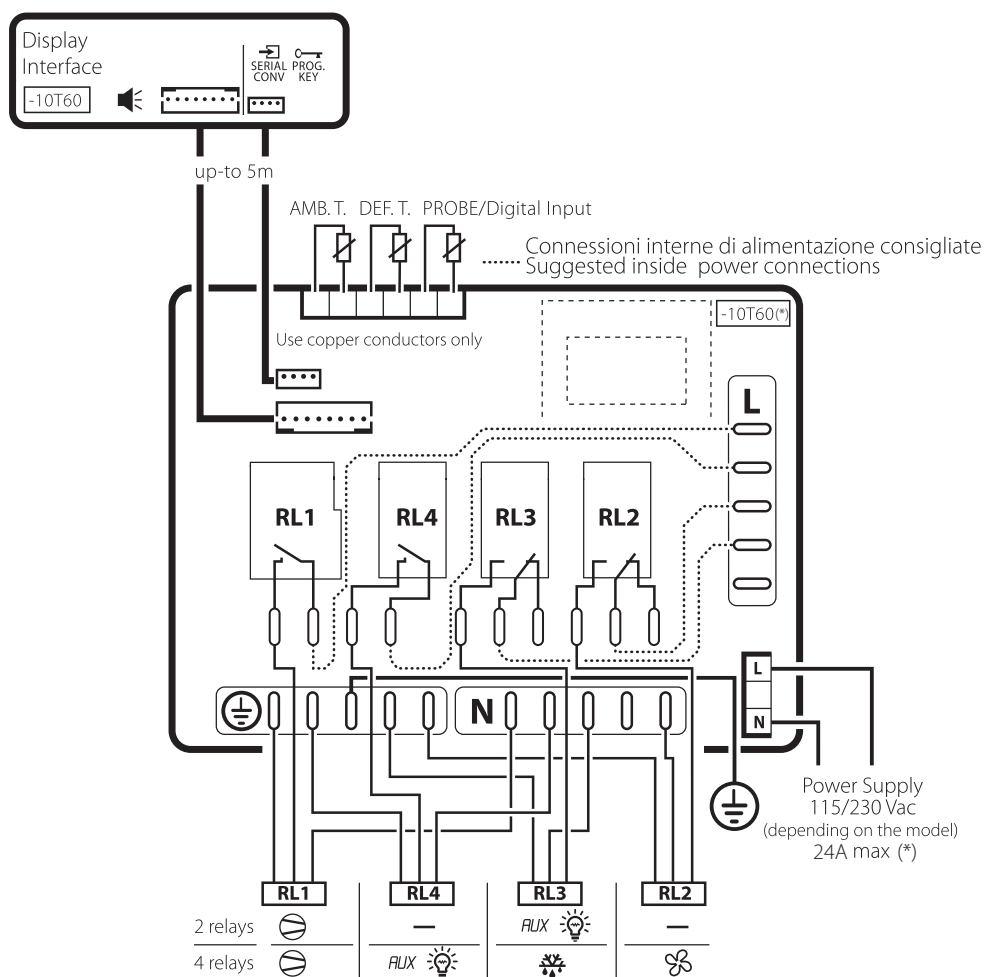

Fig. 2.g

(*) For codes PJEZ*8**5* the temperature range is -10T50 °C and the maximum current is 16 A. See the table of technical specifications.

----- = recommended internal power supply connections.

2.3 Wiring diagram for multiple units

The RS485 converter (IROPZ485S0) is used to connect the easy, easy compact and easy split instruments to the supervisor network, allowing complete control and monitoring of the easy units connected.

The system allows up to 207 units to be connected together, with a maximum length of 1000 m. The connection requires the standard accessories (RS485-USB converter, CAREL code CVSTDUMOR0) and two 120 Ω terminal resistors.

Connect the RS485 converter to the easy, easy compact or easy split using a four-wire cable and make the connections as shown in the figure. The line should be started and ended with a 120 Ω 1/4 W resistor. For the allocation of the serial address see parameter H0. The recommended connection cable is a twisted pair with shield and cross-section from 0.5 to 1.5 mm² (AW6 22-24).

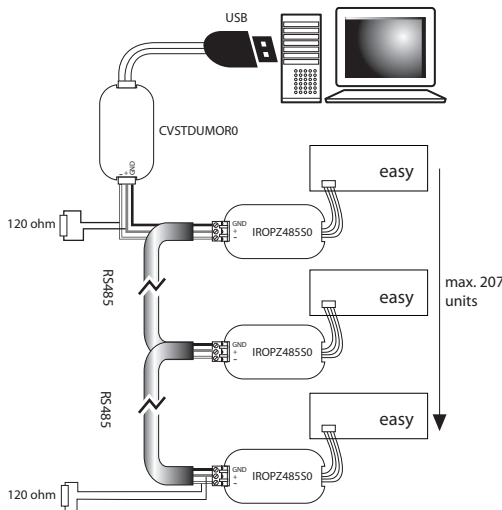

Fig. 2.h

easy split:

The serial connection for the easy split models with 4 relays depends on the setting of parameter H7, as the management of the fourth relay (RL4) and serial communication are mutually exclusive.

The factory setting is H7=1, which means the fourth relay is enabled. To enable connection to the supervisor network:

1. power down the controller;
2. disconnect the 4-wire cable from the rear of the display;
3. connect the display to converter code IROPZ485S0 and this to the RS485 network;
4. power up the controller and set H7=0 and the network address for parameter H0.

To restore the fourth relay output (RL4):

1. power down the controller;
2. disconnect converter code IROPZ485S0 from the rear of the display;
3. connect the 4-wire cable from the power board to the display;
4. power up the controller and set H7=1.

⚠ Warnings:

- the RS485 converter (IROPZ485S0) is sensitive to electrostatic discharges, and therefore must be handled with extreme care;
- check the technical documents on the CAREL IROPZ485S0 option for the description of the connection methods so as to avoid damaging the instrument;
- suitably fasten the converter so as to avoid disconnections;
- perform the wiring with the power supply disconnected;
- keep the IROPZ485S0 serial option cables separate from the power wires (relay outputs and power supply).

3. USER INTERFACE AND START UP

3.1 easy

Display

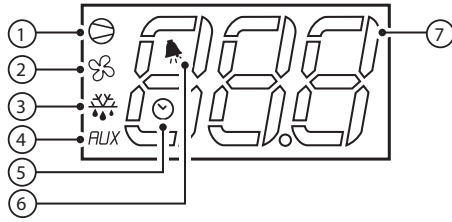

Fig. 3.a

but. no.	function	normal operation			start up
		ON	OFF	flash	
1	compressor	on	off	call	ON
2	fan	on	off	call	ON
3	defrost	on	off	call	ON
4	auxiliary output (AUX)	output active	output not active	-	ON
5	clock (RTC)	RTC available, enabled (tEN=1) and at least one time band has been set	RTC not available or not enabled (tEN=0) or no time band set	-	ON (if the clock is fitted)
6	alarm	alarm in progress	no alarm in progress	-	ON
7	digits	three digits with decimal point and range -199 to 999. See parameters /4, /5, /6 for the type of probe displayed, values in °C/°F and decimal point			

Table 3.a

Keypad (models C, S, X, Y)

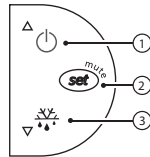

Fig. 3.b

but. no.	normal operation		start up	
	pressing the button alone	pressing with other buttons		
1	more than 3 s: switch ON/OFF	pressed together with 3 activates / deactivates the continuous cycle	-	
2	- 1 s: displays/sets the set point - more than 3 s: accesses the parameter setting menu (enter password 22) - mutes the audible alarm (buzzer)	-	for 1 s RESET current EZY set	pressed together (2 and 3) activate parameter reset procedure
3	more than 3 s: activates / deactivates the defrost	pressed together with 1 activates / deactivates the continuous cycle	for 1 s displays firmware version	

Table 3.b

3.2 easy compact

Display

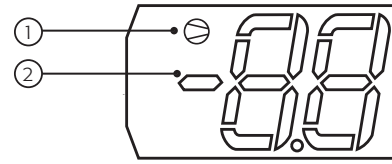

Fig. 3.c

but. no.	function	normal operation			start up
		ON	OFF	flash	
1	compressor	on	off	call	ON
2	digits	two digits with sign and decimal point, -99 to 99(*). See parameters /4, /5, /6 for the type of probe displayed, values in °C/°F and decimal point			

Table 3.c

(*) The parameters that feature three digit values can be set from the supervisor. In this case, the display will show "--".

Keypad (model S)

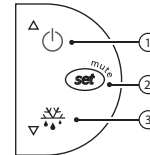

Fig. 3.d

but. no.	normal operation		start up	
	pressing the button alone	pressing with other buttons		
1	more than 3 s: switch ON/OFF	pressed together with 3 activates / deactivates the continuous cycle	-	
2	- 1 s: displays/sets the set point - more than 3 s: accesses the parameter setting menu (enter password 22) - mutes the audible alarm (buzzer)	-	for 1 s RESET current EY set	pressed together (2 and 3) activate parameter reset procedure
3	more than 3 s: activates / deactivates the defrost	pressed together with 1 activates / deactivates the continuous cycle	for 1 s displays firmware version	

Table 3.d

Keypad functions for easy and easy compact M models (models with keypad only)

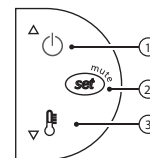

Fig. 3.e

but. no.	normal operation		start up	
	pressing the button alone			
1	more than 3 s: switch ON/OFF		-	
2	- 1 s: displays/sets the set point - more than 3 s: accesses the parameter setting menu (enter password 22) - mutes the audible alarm (buzzer)		-	pressed together activate parameter reset procedure
3	rapid selection of probe displayed		for 1 s displays firmware version	

Table 3.e

3.3 easy split

Display

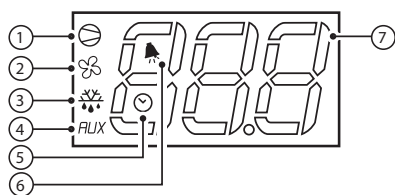

Fig. 3.f

but. no.	function	normal operation			start up
		ON	OFF	flash	
1	compressor 1/2	on	off	call	ON
2	fan	on	off	call	ON
3	defrost	on	off	call	ON
4	auxiliary output (AUX) - light	output active	output not active	-	ON
5	clock (RTC)	RTC available, enabled (tEN=1) and at least one time band has been set	RTC not available or not enabled (tEN=0) or no time band set	-	ON (if the clock is fitted)
6	alarm	alarm in progress	no alarm in progress	-	ON
7	digits	three digits with decimal point and range -199 to 999. See parameters /4, /5, /6 for the type of probe displayed, values in °C/°F and decimal point			

Table 3.e

Keypad

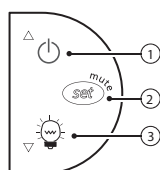

Fig. 3.g

but. no.	normal operation		start up
	pressing the button alone	pressing with other buttons	
1	more than 3 s: switch ON/OFF light (H1=4) or defrost	pressed together with 3 activates / deactivates the continuous cycle or defrost (see par. H6)	-
2	- 1 s: displays/sets the set point - more than 3 s: accesses the parameter setting menu (enter password 22) - mutes the audible alarm (buzzer)	-	for 1 s RESET current EZY set pressed together (2 and 3) activate parameter reset procedure
3	more than 3 s: activates / deactivates light (H1=4) or defrost	pressed together with 1 activates / deactivates the continuous cycle or defrost (see par. H6)	for 1 s displays firmware version

Table 3.g

3.4 Preliminary configurations

Once the electrical connections have been completed, simply power-up the controller to make it operative.

CAREL then recommends to check that the display does not show any alarm signals (see par. "5.1 Table of alarms and signals" on page 31), then set the time and date (in the models fitted with RTC, see par. "4.11 Clock and time band parameters" page. 28), and finally set the parameters as desired. The main parameters are as follows:

Control parameters

st	set point
rd	set point differential
/P (only easy split)	select type of probe

Defrost parameters

d0	type of defrost
dl	interval between two defrosts
dt	end defrost temperature
dP	maximum defrost duration

Alarm parameters

Ad	temperature alarm delay
AL	low temperature alarm threshold/deviation
AH	high temperature alarm threshold/deviation
A0	alarm and fan temperature differential

Table 3.h



Note: The procedure for modifying the parameters is described in par. "5.4 Modifying the parameters" page 32.

3.5 Functions available from the keypad

On and off

Switching the instrument ON: press UP for more than 3 s (when pressing the button, the display shows ON).

Switching the instrument OFF: press UP for more than 3 s. The display shows the message "OFF", alternating with the temperature measured by the set probe.

In off status, the following functions are disabled (if featured by the model):

- compressor control / duty setting / continuous cycle;
- defrost;
- fan control;
- alarms: 'LO', 'HI', 'IA', 'cht', 'CHT';
- door switch:
 - easy, easy compact: A4=7/8;
 - easy split: A4=7/8/10/11;
- buzzer (when available).

While the following are enabled:

- temperature display, alternating with the message "OFF";
- parameter display and setting;
- alarms: "E0", "E1", "E2";
- the internal timer relating to parameter 'dl' is updated. If 'dl' expires in OFF status, a defrost is performed when restarting;
- auxiliary relay management, only in the following configurations:
 - H1= = 1/2 ("E0" alarm only);
 - H1= 3, A4= 6;
 - H1=4 (easy split only).



Note: when exiting OFF status, the following settings are set to zero (that is, are not saved prior to OFF): evaporator fan alarm hysteresis and management (A0), temperature control hysteresis (rd), cht pre-alarm hysteresis (AE). In addition, the delays are set to zero for the display of the temperature alarms (Ad, d8, c6), dripping (dd) and post-dripping (Fd).

**Warnings:**

- when first connected, easy is already on and ready to be used;
- the instrument can be switched on from a supervisor PC and via an external contact (setting A4= 5). The latter has priority over the other modes.

Set point setting (desired temperature value)

The easy, easy compact and easy split devices control the desired temperature (set point) inside the cabinet or cold room directly and dynamically.

To view and modify the set point:

- press SET for 1 s, the set value will start flashing;
- increase or decrease the value using UP or DOWN;
- press SET to confirm the new value.



Important: the PJEZM* models fitted with keypad simply monitor the deviation from the set point and where necessary signal an alarm. On these models, the set point can only be modified using parameter "St".

Manual defrost

Not available on the easy thermometer (M) and easy compact models.

Press DOWN for more than 3 s (activated only if the temperature conditions are right, for easy split only if the light output is not set, H1≠4). Alternatively, on easy split models, if the light output is set (H1=4), the defrost can be activated by pressing UP and DOWN together, when H6=1).

Continuous cycle

Not available on the easy thermometer (M) and easy compact models.

Press UP+DOWN for more than 3 s (activated only if the temperature conditions are right and for easy split only when H6=0).

The continuous cycle is used to maintain refrigeration active in the cabinet or cold room, regardless of the temperature inside the unit. This may be useful for rapidly bringing the temperature below the set point value.

Light (easy split only)

As already mentioned, when a light output is configured (H1=4), the DOWN button switches the light on/off, otherwise it starts/stops the defrost.

Rapid display of the temperature read by the other probes (only available for easy and easy compact thermometer models - M)

Press the DOWN button to scroll the temperatures read by the probes. Each time the DOWN button is pressed, the display will show the name of the probe Pr1, Pr2 or Pr3 (only on the models with 3 inputs and with multifunction input configured as a probe) and after 1 s the temperature measured by the selected probe will be displayed.

To display the other probes, press DOWN again.

To return to the normal display, wait 3 s without pressing any buttons (exit by timeout).

4. FUNCTIONS AND PARAMETERS

This chapter describes all the functions of the easy, easy compact and easy split. See Table 1.b for the compatibility of the functions with the model used.

! Important: the easy compact models only display two digits. In the range below -99 and above 99, the terminal will display "-". The parameter codes with 3 digits are converted as follows:

easy, easy split	easy compact
/C1	-C1
/C2	-C2
EZY	EY

Table 4.a

While the messages become:

easy, easy split	easy compact
OFF	OF
dEF	dF
Pr1	P1
Pr2	P2
SEt	St

Table 4.b

4.1 Temperature probe settings

Depending on the models, the easy and easy compact controllers feature one or two analogue inputs. The easy controllers, in addition, also feature a multifunction input (analogue or digital). All easy split models have two analogue inputs and one multifunction input (analogue or digital). After installation, the values measured by the temperature probes can be corrected and stabilised using the following parameters.

/2: probe measurement stability

Coefficient used to stabilise the temperature measured by the probes. /2 acts as a "filter" on the minimum variations in the temperature measurement, and at the same time calculates the average of the readings.

- low values assigned to /2 allow a prompt response of the sensor to temperature variations (the reading becomes more sensitive to disturbance);
- high values slow down the response, but guarantee greater immunity to disturbance (more stable and more precise reading).

/3: probe display rate (easy split only)

This parameter is used to set the rate at which the temperature display is updated. The temperature shown on the display tends to follow rapid deviations away from the set point very slowly, and vice-versa, moves very quickly in the event where the temperature displayed is approaching the set point. If the control temperature exceeds the high or low temperature thresholds and an AL or AH alarm is activated, the filtering is immediately bypassed and the temperature displayed is the temperature effectively measured, until all the alarms are reset. The action of parameter '/3' only affects the temperature displayed, and not the temperature used for the control functions. The update rate decreases as the value of the parameter increases, from 1 to 15.

Value	Parameter /3
	0 = disabled
	1 = fast update
	...
	15 = slow update

Table 4.c

Example: In the case of bottle coolers, typically used in supermarkets, when the doors are opened frequently, due to the greater thermal inertia of the liquids compared to the air, and the fact that the probe is positioned in the air and not directly on the products, the instrument measures a temperature that is higher than effective temperature of the soft drinks, thus displaying a quite "unrealistic" temperature. Setting parameter '/3' to a value other than 0, any abrupt variations in temperature are "filtered" on the display, showing a temperature trend that is "closer" to the actual trend of the product temperature.

/C1/C2/C3: probe 1, 2, 3 offset

These parameters are used to correct the temperature measured by the probes (/C1 probe 1, /C2 probe 2 and /C3 probe 3), with an offset in tenths of a degree. The value assigned to this parameter is in fact added to (/C1/C2/C3>0) or subtracted from (/C1/C2/C3<0) the temperature measured by the related probe.

! Important: parameter /C3 is not available on the easy compact models.

/P: select type of probe (easy split only)

Used to select the type of probe used for the measurements:

- /P=0 standard NTC: -50T90°C;
- /P=1 high temperature NTC: -40T150°C.

4.2 Temperature display

The temperature displayed, the unit of measure and the decimal resolution can be set according to the following parameters: /4, /5 and /6.

/4: select probe displayed

Used to choose whether to display the temperature read by the control probe (Probe 1), Probe 2 or the status of the multifunction input (analogue or digital).

- Digital input =0: contact closed.
- Digital input =1: contact open.

Parameter /4 selects the probe shown on the display, all the other display and control modes remain unchanged.

! Important: the easy compact models can display up to 2 probes.

/5: select °C/°F

Defines the unit of measure used for temperature control.

- /5=0 to work in °C
- /5=1 to work in °F.

! Warning:

- when changing from one unit of measure to the other, all the values of the temperature parameters are modified to the new unit of measure.
- The max and min limits of the absolute temperature parameters are the same for both °C that °F. The range of temperatures allowed is therefore different between °C and °F:

/6: disable decimal point

Used to enable or disable the temperature display with the resolution to the tenths of a degree between -20 and + 20 (easy and easy split) or -10 and +10 (easy compact).

- /6= 0 temperature displayed to the tenth of a degree;
- /6=1 temperature displayed without the tenths of a degree.

Note: the decimal point is only disabled in relation to the reading shown on the display (the calculations performed by the controller remain unchanged).

/7: enable probe 2 alarm (M models only)

In the thermometer models (M), fitted with two probes, setting /7= 1 enables the alarm relating to the second probe (E1).

4.3 Temperature control

The following parameters are used to control the temperature: St, r1, r2, r3, r4 and rd.

St: set point, r1 minimum value and r2 maximum value of the set point

Parameter St determines the desired temperature to be maintained inside the cabinet or cold room (set point). Parameters r1 (minimum value) and r2 (maximum) set the range of temperatures for setting the set point.

Note: the set point can be set by pressing the SET button (see par. "Setting the set point (desired temperature value)" page 16).

r3: select direct/reverse operation

Defines the operating mode of the device:

- r3=0: direct with defrost. Used to request the activation of the compressor when the temperature measured by probe 1 rises above the set point. This mode also includes defrost (also called "cooling" mode, see Fig. 4.a)
- r3=1: direct without defrost (Fig. 4.a)
- r3=2: reverse without defrost (Fig. 4.a). Used to request the activation of the compressor when the temperature measured by probe 1 falls below the set point. This mode does NOT include defrost (also called "heating" mode, see Fig. 4.a).

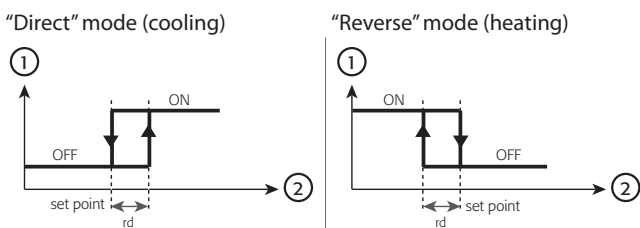

Fig. 4.a

Key:
 1. compressor request;
 2. probe 1

Important: the operating mode can also be set by external contact connected to the multifunction digital input (parameter A4=9). In this case, the contact controls operation (direct/reverse) with priority over parameter r3.

r4: night-time set point delta

Value that automatically increases the set point temperature during the night-time operation time bands.

- r4=0: night-time set point= St
- r4>0: night-time set point= St + r4

Important:

1. to enable night-time operation, not only does r4 need to be set >0, but the digital input must also be enabled and configured (see parameter A4=4 curtain switch/night-time operation) or a night-time time band enables (see par. "4.11 Clock and time band parameters" page 28);
2. night-time operation does not necessarily mean at night, but rather the time bands in which the value of the set point is modified. This usually corresponds to the period in which the refrigerated cabinet is not used (shop closed) and when the curtain is down.

rd Control differential

Value that is added to (or subtracted from, in 'reverse' mode) the temperature set point.

- rd= low values:
 - more precise temperature control;
 - high compressor On/Off switching frequency in the event of minimum temperature deviations (with the risk of causing damage).
- rd= high values:
 - less precise temperature control;
 - low compressor On/Off switching frequency in the event of minimum temperature deviations.

Important: the compressor can also be safeguarded using the parameters that limit the number of activations/hour and the minimum off time (see par. "4.6 Compressor protection" page 19).

4.4 Duty Setting

Safety function that ensures the operation of the compressor even in the event of a control probe fault. If alarm E0 occurs, duty setting ensures the operation of the compressor until the fault is resolved. The compressor, not being able to be activated according to temperature, works cyclically with an ON time equal to the value assigned to parameter c4 (in minutes) and a fixed OFF time of 15 minutes, see Fig. 4.b.

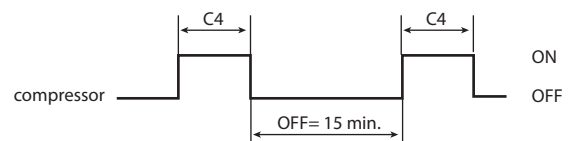

Fig. 4.b

c4: compressor on time with duty setting

c4= 0	in the event of an ambient probe fault, the compressor will be always off
c4= 100 (c4=99 for easy compact)	the compressor will remain always on; and the 15 minute off time is not considered.
0<c4<100 (0<c4<99 for easy compact)	at the moment a probe error (E0) is detected, the duty setting cycle starts from the current status of the compressor (that is, the status of the compressor is maintained) and the time already elapsed is ignored. The compressor times set by parameters c1, c2, c3 are all always observed.

Table 4.d

Duty setting and defrost

If the control probe error occurs when the controller is in defrost mode, the function is not stopped but rather is completed as required; in addition, the defrost can still be performed when called. During the defrost, the duty setting timer is not stopped but rather keeps counting the ON and OFF times.

Duty setting and continuous cycle

If the continuous cycle is operating, the controller instantly exits this status and activates duty setting (also for safety reasons, given that during the continuous cycle the low temperature alarm is disabled). To re-activate continuous cycle operation, the ambient probe fault must be resolved. If the probe error is no longer present, the unit returns to normal operation. The compressor again takes on the logic of the control, respecting the times c1, c2, c3.

4.5 Continuous cycle

The continuous cycle is used to maintain refrigeration continuously active, regardless of the temperature inside the unit. The function is used to rapidly lower the product temperature, even below the set point, for example after filling the cabinets. In this phase, the temperature may fall below the set point. To activate or deactivate the continuous cycle from the keypad, see paragraph 3.5, the display shows "cc" and the  icon flashes (2 flashes, pause).

cc: continuous cycle duration

This represents the time in hours that the compressor operates continuously for so as to lower the temperature, even below the set point. If cc=0 the continuous cycle is not activated. The controller exits the continuous cycle procedure after the time set for parameter "cc" has expired, or when reaching the minimum temperature (see the minimum temperature alarm, parameter AL).

c6: temperature alarm bypass after continuous cycle

This is the time in hours during which all the temperature alarms are deactivated after a continuous cycle. If the temperature of the refrigerated unit, after the continuous cycle, lowers due to inertia below the minimum temperature threshold (set point-AL), the activation of the low temperature alarm is delayed for the time c6. In any case, the continuous cycle is deactivated at the temperature (set point-AL).

4.6 Compressor protection

The easy, easy compact and easy split controllers are fitted with an automatic compressor protection system to avoid continual starts or stops of the unit. The protection is based on the times in minutes set for parameters c0; c1; c2; c3:

c0 compressor and fan start delay on power-up

When the controller is powered-up, this delays the start of the compressor and the evaporator fan (see Fig. 4.c).

c1 minimum time between consecutive compressor starts

Delay between two consecutive starts of the compressor (see Fig. 4.d).

 **Note:**

- if the maximum number of starts/hour allowed is 10, simply set c1=6 to ensure this limit is observed.
- as well as c1, also remember that parameter "dd" (dripping time) stops the compressor and the evaporator fan after a defrost..

c2/c3 minimum compressor off/on time

These determine the minimum off time (c2) and on time (c3) for the compressor. The compressor will not be controlled until times c2 and c3 have elapsed (see Figs. 4.e and 4.f).

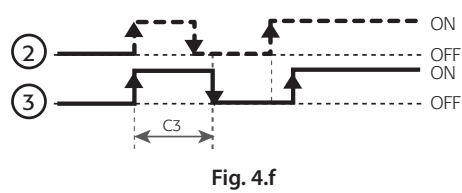
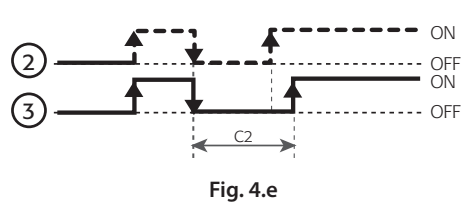
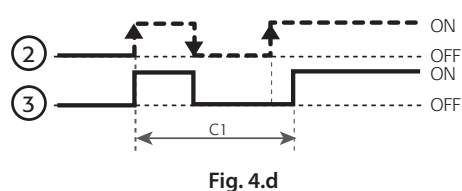
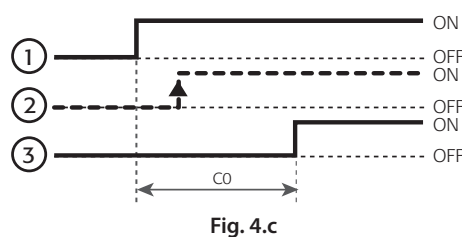

Key to Figs 4.c...4.f

- 1 instrument power-up;
- 2 compressor call;
- 3 compressor

c11: second compressor delay (easy split only)

This parameter determines the delay in the activation of the second compressor compared to the main compressor. The parameter has no effect on the deactivation of the compressor.

 **Important:** select the auxiliary output as the second compressor output in parallel (H1 = 5), second compressor with two step control, without rotation (H1 = 6) or second compressor with two step control, with rotation (H1=7).

4.7 Defrost

For the correct and safe use of the easy, easy compact and easy split controllers, it is essential to program defrost cycles.

Type of defrost (parameter d0):

The defrost may be performed by stopping the compressor, heater or hot gas.

In addition, it can be managed:

- by temperature: using the defrost probe located on the evaporator. In any case, the defrost will end after a maximum settable safety duration. The end defrost for maximum duration alarm "Ed" (parameter A8) can be disabled.
- by time: when there is no defrost probe.
- by time with temperature control (heater only); for a programmable time: the defrost output is only activated when the temperature is below the end defrost threshold, guaranteeing energy saving and defrosting of the evaporator even in more extreme situations (see Fig. 4.g).

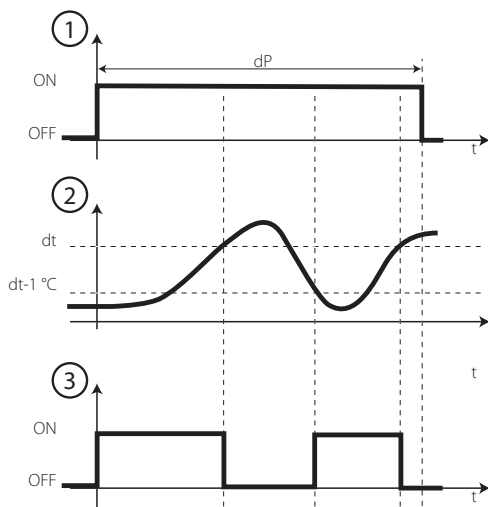

Fig. 4.g

Key

- 1 defrost call;
- 2 defrost temperature probe;
- 3 defrost heater.

d0	type of defrost	type of end defrost
0	heater	by temperature
1	hot gas	
2	heater	by time
3	hot gas	
4	heater with temperature control	

Table 4.e

Important: on the easy and easy compact models and the easy models without defrost relay, defrost can only be performed by stopping the compressor. In these cases, the defrost may be managed by time (recommended d0=2) or temperature (if the defrost probe is present, recommended d0=0).

How to start the defrost:

- from the keypad pressing the DOWN button for 3 s (manual defrost) (for easy split H1 must be ≠4. If H1=4 the UP and DOWN buttons can be pressed together, when H6=1);
- by digital input (in the models where fitted, setting parameter A4=3);
- from the supervisor;
- setting the time bands (if RTC available /enabled);
- at the end of the interval between two defrosts (parameter dl>0);
- when switching the instrument on (parameter d4=1).

Important: the easy compact models, not having the RTC nor the digital input, cannot be set with defrost time bands and cannot be connected to an external contact for defrost management.

The defrost may be called, but not activated, in the following cases:

- continuous cycle;
- dripping (dd>0);
- post-dripping (Fd>0);
- compressor protectors;
- off status;
- disabling from digital input(A4=2);
- setting the time delay (d5>0) for the defrost function when the instrument is switched on (d4=1);
- direct control mode only without defrost (r3=1) or reverse (r3=2) (in this case the defrost is not called);
- defrost by temperature (d0=0, 1) and temperature measured by the defrost probe above the end defrost set point (dt).

The defrost ends correctly:

- at the end of the pre-set time (see parameter "dP");
 - once having reached the set temperature (dt).
- When the defrost ends correctly, the dripping (equal to the time set for parameter dd) and post-dripping (parameter Fd) phases start.

The defrost ends early:

- from the keypad, pressing the DOWN button for 3 s (manual end defrost, for easy split H1 must be ≠4 or pressing UP+DOWN together 3 s when H6=1);
- due to an immediate external alarm "IA";
- due to a dirty condenser alarm "CHt";
- by setting direct mode only without defrost (r3=1) or reverse (r3=2);
- switching off;
- when requested from the supervisor;
- from digital input (see parameter A4=2) (the defrost call remains pending).

In these cases, the early end of the defrost is not followed by dripping and post-dripping.

Important:

- the defrost is only available in direct mode, that is, when parameters r3=0 or A4=9 (the latter has priority over r3);
- using parameter d0, and according to the model available, type of defrost to be activated can be selected;
- the defrost has priority over normal temperature control; it may also have priority over the compressor protectors (see parameter d9);
- during the defrost, the temperature display can be frozen (see parameter d6);
- the continuous cycle has priority over the defrost

Parameters for configuring the defrost

dl: interval between defrosts

The defrost is performed periodically at a frequency of every "dl" (in hours or minutes, see parameter dC). The interval starts counting from the start of the current defrost. If the time is equal to 0 (dl=0), the defrost is not performed, except when activated from the keypad, by digital input, from the supervisor or by time band. During defrosts the temperature alarms are inhibited.

dt: end defrost temperature set point/defrost temperature threshold with temp. control

For the models fitted with end defrost probe, this parameter allows an evaporator temperature to be set at which the defrost is stopped (the evaporator temperature is measured by the defrost probe). The end defrost temperature differential is fixed at 1° C (defrost with temperature control, d0= 4).

If at the start of a defrost cycle with the controlled output by temperature (d0=0, 1) the temperature measured by the probe is greater than the value set for "dt", the defrost is not performed.

In the event of defrost probe failure, the controller performs a timed defrost with a duration equal to the value set for "dP". The same is true if the end defrost set point can not be reached, the defrost is stopped after a maximum time equal to the value of dP, and the error Ed is displayed (if enabled by A8) and stays on until a correct defrost cycle is performed.

dP: maximum defrost duration

Determines the maximum duration of the defrost (in minutes or seconds, see parameter dC). When defrost by time is set (d0= 2/3/4) dP represents the effective duration of the defrost.

d4: defrost when switching the instrument on

Starts a defrost when switching the instrument on (d4= 1). This has priority over the activation of the compressor and the continuous cycle.

Running a defrost when switching the instrument on may be useful in special situations (e.g. frequent power failures).

Case 1: the system is subject to frequent power failures

In the event of power failures the instrument's internal clock, which calculates the interval between two defrosts, starting from zero, is reset. If the frequency of the power failure were, in an extreme case, greater than the defrost frequency (e.g. a power failure every 8 hours against a defrost every 10 hours), the controller would never perform a defrost. In this type of situation it is better to activate the defrost when the unit is turned on (d4=1), above all if the defrost is controlled by temperature (probe on the evaporator), so unnecessary defrosts are avoided or at least reduced in duration.

Case 2: Systems with many refrigeration units

In this situation, if the defrost on power-up is activated (d4= 1) after a power failure all the units will start a defrost. This may cause overloads. To avoid this, parameter "d5" can be exploited, which allows a delay to be set before the defrost starts, a delay which obviously must be different for each unit.

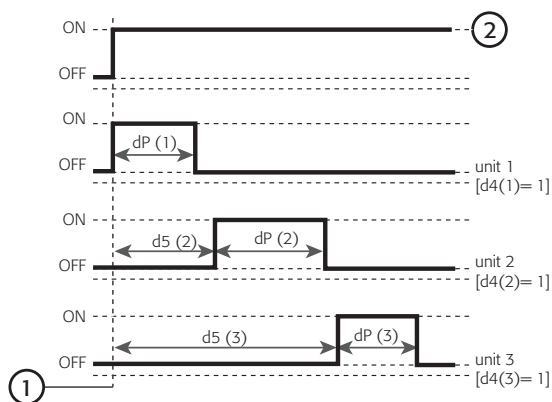

Fig. 4.h

Key:
1 power-up 2 voltage

d5: defrost delay on power-up or when enabled by digital input

Represents the time which must elapse between when the controller is turned on and the start of the defrost.

The digital input can be used to start a defrost from external contact (see parameter A4=3); d5 represents the delay between when the defrost is enabled, or called, and when it effectively starts. The defrost from digital input can be exploited to perform defrosts in real time when is the RTC option is not fitted. Simply connect a timer to the multifunction digital input. The defrost will be activated when the timer contact is closed. In the case where more than unit is connected to the same timer, it is recommended to set parameter d5 to delay the defrosts to a different time for each unit. Furthermore, to avoid unnecessary defrosts controlled by the instrument's internal clock, it is suggested to set parameter dl=0 (only manual defrosts from the keypad or multifunction contact) or to set dl to a value which is greater than the maximum set interval.

A4	Meaning	d5
3	start defrost on closing	delay between call and effective start

Table 4.f

d6: freeze control temperature display during defrost

This function locks the display of the ambient temperature during the defrost cycle at the last value read before the current defrost (d6= 1).

d6= 0 display the message "dF" alternating with the temperature measured by the control probe;

d6= 1 freeze the display on the last temperature measured before the defrost.

The display normally returns when the measurement first reaches the set point or, in any case, after the set alarm bypass time after defrost (parameter d8).

The freeze mode is also valid for the display of the second and third probe, if enabled (parameter /4).

dd: dripping time

This parameter forces the compressor and the evaporator fans off after a defrost, in order to allow the evaporator to drip.

The value of this parameter indicates the number of minutes the compressor and fan are off. If dd = 0 no dripping is set, therefore at end defrost the compressor starts immediately.

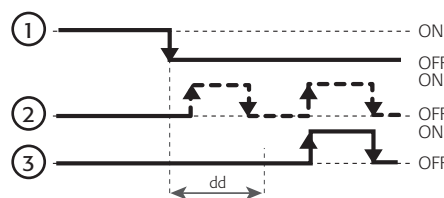

Fig. 4.i

Key:
1 defrost;
2 start compressor call;
3 compressor.

d8: alarm bypass time after defrost

The parameter has two effects:
1. it delays the temperature alarm signal after a defrost;
2. it delays the temperature alarm signal after opening the door. In this case, it is only active when A7=0.

d9: defrost priority over compressor protectors

Cancels the compressor protection times (c0, c1, c2, c3) at the start of the defrost. The possible values are:

d9= 0 protection times observed;
d9= 1 protection times ignored; the defrost has higher priority and the compressor times are not observed.

It is useful, for example, with hot gas defrost to avoid delaying the defrost in the case where the compressor has just stopped and there is a minimum time between two starts. Remember, however, that in this case the maximum number of activations per hour of the compressor may not be respected.

d/: defrost probe reading

Used to display the value measured by the defrost probe on the instruments where this is fitted.

dC: time base

Used to modify the unit of measure used to count the times for parameters dl (defrost interval) and dP (defrost duration). The following values are available:

dC	dl	dP
0	hours	minutes
1	minutes	seconds

Table 4.g

The parameter dC=1 can be useful to:

- test the operation of the defrost function with reduced times;
- manage air driers. The defrost cycle thus becomes the condensate drain cycle, which must occur at close intervals (minutes) and for very brief durations (seconds).

! Important: this parameter should not be used (dC= 1) if the defrost requires the activation of the compressor (hot gas) and when d9=1, as otherwise the compressor may be damaged due to a number high of consecutive starts.

4.8 Alarm parameters

The alarms can be set as regards the threshold, type and activation delays.

When an alarm occurs, the unit may stop normal operation and warn that the alarm situation has occurred, based on the type of alarm.

A0: alarm and fan temperature differential

This represents the differential used to activate the high and low temperature alarms ("AH", "AL") and for the management of the fan.

In the event of an alarm, as seen in the figure, the value of "A0" determines the actual activation of the temperature alarms.

The value of "A0" (negative or positive) defines the nature of alarms "AL" and "AH" (absolute or relative, respectively), in detail:

- A0 ≤ 0 AL and AH expressed as absolutes
- A0 > 0 AL and AH expressed relative to the set point (St or St + r4 in night-time operation)

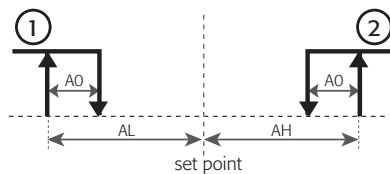

Fig. 4.j

- Key:**
- 1 low temperature alarm;
 - 2 high temperature alarm.

AL: absolute or relative temperature for low temperature alarm

Determines the activation threshold of the low temperature alarm.

AL	Low temperature alarm (normal) if...	Low temperature alarm (night-time) if...	Alarm disabled if...
absolute	temp. probe 1 ≤ AL	temp. probe 1 ≤ AL	AL = -50
relative	temp. probe 1 ≤ St - AL	temp. probe 1 ≤ St + r4 - AL	AL = 0

Table 4.h

AH: absolute or relative temperature for high temperature alarm

Determines the activation threshold of the high temperature alarm.

AH	High temperature alarm (normal) if...	High temperature alarm (night-time) if...	Alarm disabled if...
absolute	temp. probe 1 ≥ AH	temp. probe 1 ≥ AH	AH = 150
relative	Temp. probe 1 ≥ St + AH	temp. probe 1 ≥ St + r4 + AH	AH = 0

Table 4.i

Note: the low and high temperature alarms are automatically reset - this means that if the temperature returns within the allowed range, the alarm signal is automatically cancelled. During a high or low temperature alarm, the message "HI" or "LO", respectively, flashes on the display alternating with the temperature; if fitted, the buzzer is activated.

Ad: temperature alarm delay

Indicates after how many minutes the temperature alarm is signalled from when it is detected. If the temperature, after the delay Ad, is within the allowed limits, the alarm is not signalled. Setting a delay to signal of the temperature alarms may help eliminate false alarms due to interference on the probe signal or situations lasting a short time (for example, opening the cold room door briefly). The temperature alarm delay has no effect on two special functions: defrost and continuous cycle. To delay any temperature alarms after these functions, parameter d8 for defrost and c6 for continuous cycle must be modified. Remember that during defrost and continuous cycle no temperature alarms are generated.

Def.: Ad=0 (instant temperature alarm).

A4: 3rd input configuration (easy compact)

The multifunction input is only available on the easy models with three inputs; is not available on the easy compact models.

This parameter is used to set the functions of the input.

easy, easy compact

A4	Meaning
0	Input not active
1	External alarm: instant (A7= 0) or delayed (A7>0) Input open= alarm Input closed= ok
2	Enable defrost Input open= disabled Input closed= enabled
3	Start defrost when closing MODEL M: select probe displayed Input open= probe 1 Input closed= probe 2
4	Curtain switch or night-time operation Input open= normal set point Input closed= night-time set point [r4]
5	Remote ON - OFF Input open= OFF Input closed= ON
6	Direct operation of AUX output when H1= 3 Input open= AUX de-energised Input closed= AUX energised
7	Door switch with evaporator fans off 'dor' alarm: - instant (A7= 0) or delayed (A7>0) - operation of AUX output (H1= 3) Input open= door open Input closed= door closed
8	Door switch with evaporator fans and compressor off 'dor' alarm: - instant (A7= 0) or delayed (A7>0) - operation of AUX output (H1= 3) Input open= door open Input closed= door closed
9	Direct / reverse operating mode IF r3 = 0 input open= direct + defrost input closed= reverse IF r3 = 1 / 2 input open= direct input closed= reverse
10	Probe for dirty condenser alarm
11	Product probe

Table 4.j

CAREL

A4=0 multifunction input disabled

The multifunction input is not activated and cannot be used as a digital or analogue input.

A4=1 external alarm

contact open= alarm detected
contact closed= normal operation.

When A4=1 easy can be connected to an external contact for immediately signalling alarms. The alarm signal can be delayed by setting parameter A7.

The activation of the alarm brings about a message on the display (see par. "5.1 Table of alarms and signals" on page 31), activates the buzzer (if featured), and stops the compressor due to external alarm (immediate if A7=0), while the fan continues operating according to parameters F0, F1, F2, F3, Fd.

If the external alarm is detected during a defrost or a continuous cycle, the controller stops these (without completing dripping and post-dripping for defrosts). When the alarm ceases, the unit resumes normal operation, and then:

- the continuous cycle (cc) can be performed again;
- defrosts can be performed;
- the compressor will start after the time set for parameter c2 (minimum compressor off time).

A4=2 Enable defrost

contact open= not enabled
contact closed= enabled.

When A4=2 easy can be connected to an external contact for enabling the defrost; this will then be activated only if the contact is closed and after the delay set for parameter d5.

If the contact is closed when a defrost in progress, the defrost is immediately stopped and the unit resumes normal operation (without performing the dripping or post-dripping phases). The  LED starts flashing indicating that the defrost call is still pending, awaiting enabling (closing of the contact), when the defrost restarts (the timer dP is set to zero).

A4=3 Start defrost on closing

The defrost call is generated when the digital input switches from open to closed.

When A4=3 easy can be connected to an external contact for starting the defrost when the contact closes. Setting dI=0 (no interval between two defrosts) and without any time bands enabled, closing the external contact will immediately start the defrost.

This function is useful for running timed defrosts without the RTC on board (used to set the defrost time bands). To do this, simply connect a mechanical or electronic timer to the digital input and set A4=3 to guarantee the defrost cycles.

A series of units can be connected to the same timer. In this case, to prevent all the defrosts from starting at the same time, set parameter d5 to different times for each unit connected (see Fig. 4.k).

In models PJEZM* this is used to select the probe whose value is displayed by the instrument:

contact open= probe 1
contact closed= probe 2.

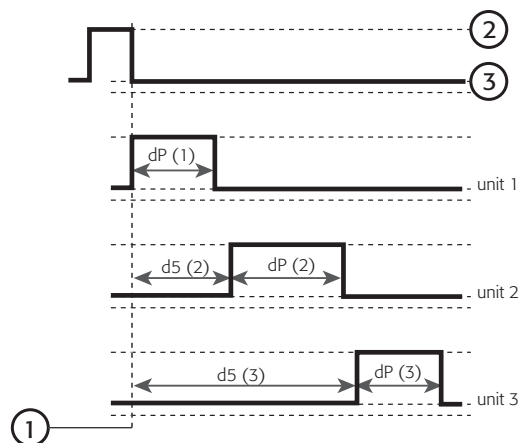

Fig. 4.k

Key:

- 1 defrost call;
2 open;
3 closed.

A4=4 Curtain switch and night-time operation

contact open= curtain raised, normal operation
contact closed= curtain lowered and night-time operation

When A4=4 easy can be connected to an external contact for managing the opening and the closing of the curtain on the refrigerated cabinet and activating night-time operation.



Important:

3. when the contact is closed the temperature set point becomes the night-time setting and consequently the value of "st" is increased ("direct" mode) or decreased ("reverse" mode) by the value of r4;
4. night-time operation does not necessarily mean at night, but rather the time bands in which the value of the set point is modified. This usually corresponds to the period in which the refrigerated cabinet is not used (shop closed) and when the curtain is down.

Contact	Operation	Operating mode	Set point
open	normal	direct / reverse	St
closed	night-time	direct	St + r4
		reverse	St - r4

Table 4.k

A4=5 Remote ON – OFF

contact open= controller off
contact closed= controller on.

When A4=5 easy can be connected to an external contact for switching instrument on/off. ON-OFF from external contact has priority over the keypad and the supervisor.

See par. "3.5 Functions available from the keypad" page 15 for further details on the functions of the instrument when OFF.

A4=6 Direct operation of AUX output with H1=3

contact open= AUX output not active
contact closed= AUX output active

When A4=6 easy can be connected to an external contact for controlling the auxiliary output (H1=3 auxiliary output linked to the digital input).

A4=7 Door switch with evaporator fans off

contact open= door open
contact closed= door closed

This is used to signal the door open alarm and stop the evaporator fan. See paragraph 4.9 "Door open/closed management".

A4=8 Door switch with evaporator fan and compressor off
 contact open= door open
 contact closed= door closed

See A4=7 with the addition of shutting down the compressor during the pre-alarm (A7 or d8). Enabling the digital input A4=8 has priority over the compressor protection parameters (c0, c1, c2, c3). See paragraph 4.9 "Door open/closed management".

A4=9 Direct/reverse operating mode
 contact open= direct operation
 contact closed= reverse operation

Parameter A4=9 has priority over parameter r3; only r3= 0 specifies the activation of the defrost control.

r3	contact	result
0	open	Direct operation with defrost control
	closed	Reverse operation
1	open	Direct operation
	closed	Reverse operation
2	open	Direct operation
	closed	Reverse operation

Table 4.I

A4=10 Probe for dirty condenser alarm

Multifunction analogue alarm input and dirty condenser pre-alarm, using the third probe.

To enable this function, set:

1. third probe;
2. parameter Ac: temperature set point above which easy signals the dirty condenser alarm;
3. parameter AE: temperature differential that, together with Ac, determines the dirty condenser pre-alarm;
4. parameter Acd: dirty condenser alarm signal delay;
5. parameter A4=10: enable the probe and dirty condenser alarm.

"cht" dirty condenser pre-alarm:

- indicates that the limit between Ac and AE has been exceeded (deriving from the calculation: $Ac-AE/2$, see Fig. 4.I);
- easy continues normal operation;
- automatic reset (if the temperature measured by probe 3 falls below $Ac-AE$);
- "cht" is shown on the display, alternating with the current temperature.

"CHt" dirty condenser alarm:

- indicates that the temperature set point Ac has been exceeded (see Fig. 4.I);
- the delay time Acd has elapsed;
- easy stops all functions;
- the buzzer sounds (to mute this, press SET or to disable deactivate set H4=1);
- "CHt" is shown on the display, alternating with "cht" and the current temperature.

! Important: the "CHt" alarm (see par. "5.1 Table of alarms and signals" on page 31) can only be reset manually, or alternatively by switching the controller off, pressing UP for 3 s or powering down (on power-up, if the temperature is still above the "Ac", the alarm will go off again).

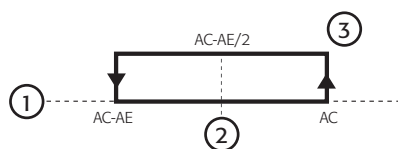

Fig. 4.I

Key:

- 1 condensing temperature;
- 2 "cht" pre-alarm, display only (automatic reset);
- 3 "CHt" alarm and refrigeration "OFF" (manual reset).

A4= 11: Product probe

3rd input (terminal 11) configured as product probe

The input is used in analogue mode for probe 3 (product).

Below is a summary table of the relation between parameter A4 and the actuators:

	outputs			
	alarm	AUX	FAN	COMP
A4= 1	"IA"	-	-	✓
A4= 6	-	✓	-	-
A4= 7	"dor"	✓	✓	-
A4= 8	"dor"	✓	✓	✓

Table 4.m

A4: 3rd input configuration (easy split)

This paragraph highlights the differences in the setting of parameter A4 for easy, easy compact and easy split.

easy split

A4	Meaning
0	Input not active
1	Instant (A7= 0) or delayed (A7 >0) external alarm Input open= alarm Input closed= ok
2	Enable defrost Input open= disabled Input closed= enabled
3	Start defrost when closing FOR MODEL M: select probe displayed Input open=probe 1 Input closed=probe 2
4	Curtain switch or night-time operation Input open= normal set point and light on (H1=4) Input closed= night-time set point [r4] and light off (H1=4)
5	Remote ON-OFF Input open= OFF Input closed= ON
6	Direct operation of AUX output when H1=3 Input open= AUX de-energised Input closed= AUX energised
7	Door switch with fan off and light not managed (see parameter Ado) "dor" alarm: - instant (A7= 0) or delayed (A7 >0) - operation of AUX output (H1= 3) Input open = door open Input closed = door closed
8	Door switch with fan and compressor off and light not managed (see parameter Ado) "dor" alarm : - instant (A7= 0) or delayed (A7 >0) - operation of AUX output (H1= 3) Input open = door open Input closed = door closed
9	Direct / reverse operating mode IF r3= 0 input open= direct + defrost input closed= reverse IF r3= 1/2 input open= direct input closed= reverse
10	Door switch with evaporator fan off and light managed (see parameter Ado)
11	Door switch with evaporator fan and compressor off and light managed (see parameter Ado)
12	Select EASY SET from digital input
13	Probe for dirty condenser alarm
14	Product probe

Table 4.o

A4=0, 1, 2, 3; see A4=0, 1, 2, 3 for easy, easy compact in previous paragraph.

A4=4 Curtain switch and night-time operation

See the previous paragraph. In easy split models if the light output is configured (H1=4) in normal operation the light is on and in night-time operation it is off.

A4=5,6 see A4=5, 6 for easy, easy compact in previous paragraph.

A4=7 Door switch with evaporator fan off and light not managed
See A4=7 for easy, easy compact in previous paragraph. In easy split models with light output configured (H1=4), the status of the light output remains unchanged. See paragraph 4.9 "Door open/closed management".

A4=8 Door switch with evap. fan and comp. off and light not managed.
See A4=8 for easy, easy compact in previous paragraph. In easy split models with light output configured (H1=4), the status of the light output remains unchanged. See paragraph 4.9 "Door open/closed management".

A4=9: See A4=9 for easy, easy compact in previous paragraph.

A4=10: Door switch with evaporator fan off and light managed
See paragraph 4.9 "Door open/closed management".

A4=11: Door switch with evaporator fan and comp. off and light managed
See paragraph 4.9 "Door open/closed management".

A4=12: Select EASY SET from digital input
Used to select the set of control parameters control according to the status of the digital input.
Digital input open = easy set 1
Digital input closed = easy set 2
The easy set from digital input has higher priority than parameter EZY; this means that any attempt to change the easy set using parameter EZY is ignored if A4 = 12.

A4 = 13: Probe for dirty condenser alarm
See A4=10 for easy, easy compact in previous paragraph.

A4 = 14: Product probe
See A4=11 for easy, easy compact in previous paragraph.

Summary table of relationship between parameter A4 and the actuators:

	output				
	alarm	light	AUX	FAN	COMP
A4=1	"IA"	-	-	-	✓
A4=6	-	-	✓	-	-
A4=7	"dor"	-	✓	✓	-
A4=8	"dor"	-	✓	✓	✓
A4=10	-	✓	✓	✓	-
A4=11	-	✓	✓	✓	✓

Tab. 4.p

Other alarm parameters

A7: digital input alarm delay
Sets the delay (in minutes) for detecting the external alarm when A4= 1, 7 or 8. For easy split A4 must be =1,7,8,10,11.

A8: enable alarm "Ed" (end defrost by timeout)
The alarm 'Ed' signals the end defrost due to the "maximum defrost time" (dP) being reached. This can be disabled, by setting A8=0.
The signal "Ed" disappears when the next defrost is called.

Ac: Dirty condenser alarm set point
Sets the temperature set point above which the dirty condenser alarm "CHt" is signalled (see parameter A4=10 for easy, easy compact and A4=13 for easy split).

AE: Dirty condenser alarm differential temperature
Sets the temperature value for determining the dirty condenser pre-alarm "cht" interval (see parameter A4=10 for easy, easy compact and A4=13 for easy split).

Acc: dirty condenser alarm delay
Sets the delay in minutes before activating the dirty condenser alarm "CHt" (see parameter A4=10 for easy, easy compact and A4=13 for easy split).

4.9 Door open/closed management

- Procedure for setting the digital input:
1. make sure that the cold room door is fitted with a contact for signalling when the door is opened and closed;
 2. establish the time required (parameters: A7 time in minutes or d8 in hours ≠0) to enable the pre-alarm on the display and to stop the evaporator fan;
 3. enable the digital input A4=7, 8. For easy split A4 must be =7,8,10,11.

When the door is opened, the controller will start counting the pre-alarm time if A7 or d8 are other than zero. If, on the other hand, A7=0 and d8=0 the alarm will be activated immediately and the display will show "dor" alternating with the temperature reading. The alarm can only be reset when the door is closed, or alternatively when switching off the controller by pressing UP for 3 s (on power-up, if the door is still open, the pre-alarm time will start counting again).

 **Important:** setting A7=0 and d8=0 ignores the pre-alarm times, the display will show "dor" alternating with the temperature and the fan will not stop.

- Special cases:
- continuous cycle: performed normally, however the evaporator fan is stopped based on the times set for A7;
 - defrost: performed normally and the activation of the fan is controlled using parameter F3 (evaporator fan status during defrost). If F3=1 the digital input will only signal the opening of the door, without having any effect on the fan.

Easy and easy compact

- During the pre-alarm (A7 or d8≠0):
- the fan is stopped;
 - the LEDs and temperature display flash (excluding the compressor LED, if on);
 - the high temperature alarms are disabled.

- During the "dor" alarm (at the end of the pre-alarm A7 or d8):
- the fan resumes normal operation;
 - the display will show "dor" alternating with the temperature;
 - the high temperature alarms are enabled;
 - the buzzer sounds (to mute this, press SET or to disable set H4=1);
 - if the auxiliary AUX output is "linked" to the digital input (H1=3) the auxiliary relay will be activated.

Example: Setting A4=7 and A7=10 on a cold room with door contact, when the door is opened, the LED and the temperature will flash on the display for 10 minutes (excluding the compressor LED) and the fan will stop. After 10 minutes, if the door is still open, the fan will resume normal operation and the display will show the "dor" signal alternating with the temperature value displayed.

Easy split

In easy split models the algorithm for managing the door depends on the type of unit selected, according to parameter Ado, and the setting of parameter A4.

Ado = 0: display case

Opening the door:

When opening the door, if parameter A7 or d8 ≠ 0, the controller goes into pre-alarm status:

- the temperature displayed and the alarm icon (bell) flash;
- the high temperature alarm is disabled;
- if A4=7, 10 the fan is stopped;
- if A4=8, 11 the fan and the compressor are stopped;
- if A4=10, 11 and if the light output is configured (H1=4), the light is on.

If the door remains open for a time greater than A7, the controller goes into alarm status:

- the temperature displayed flashes alternating with 'dor';
- the buzzer is activated;
- the light remains on if an output is configured as the light output (H1=4);
- the high temperature alarm is enabled, after the delay Ad;
- the auxiliary relay is activated if H1 = 3;
- the fan is ON;
- if A4=8, 11 the compressor is restarted, observing any protection times ('c' parameters);

Closing the door:

The controller resumes normal operation:

- the fans and the compressor are started if called (observing any protection times – 'c' parameters)
- the light is switched off if an output is configured as the light output (H1= 4);
- the auxiliary relay is deactivated if H1 = 3;
- the buzzer is deactivated;
- the temperature stops flashing and the alarm icon (bell) goes off;
- the high temperature alarm is enabled after the delay Ad.

Ado = 1: cold room

Assuming the user enters the cold room, closing the door behind him, and then exits the room, closing the door a second time. If the user enters the cold room and then leaves immediately, closing the door, the controller waits until the door is opened a second time and if this does not occur within a certain time (A7 or d8), normal operation resumes.

Opening the door the first time:

When opening the door, if parameters A7 and d8 are ≠ 0, the controller goes into pre-alarm status:

- the temperature displayed and the alarm icon (bell) flash;
- the high temperature alarm is disabled;
- if A4=7, 10 the fan is stopped;
- if A4=8, 11 the fan and the compressor are stopped;
- if A4=10, 11 and if the light output is configured (H1=4), the light is activated;

If the door remains open for a time greater than A7, the controller goes into alarm status:

- the fans and compressor are started if called; when restarting the compressor the protection times are observed ('c' parameters);
- the light remains on if an output is configured as the light output (H1= 4);
- the auxiliary relay is energised if H1 = 3;
- the temperature displayed flashes alternating with 'dor';
- the buzzer is activated;
- the high temperature alarm is enabled after the delay Ad.

Closing the door the first time:

the controller maintains the previous status:

- the fans and/or compressor (see parameter 'A4') remain off;
- the light is kept on if an output is configured as the light output (H1 = 4);
- the temperature and the alarm icon (bell) flash;
- the high temperature alarms remains disabled.

If, after first closing, the door remains closed for a time greater than A7, the controller resumes normal operation:

- the fans and/or compressors are switched on if called; when the compressor restarts the protection times must be observed ('c' parameters)
- the light remains on if an output is configured as the light output (H1 = 4);
- the high temperature alarm is enabled after the delay Ad;
- the temperature stops flashing and the alarm icon (bell) goes off.



Note: assuming the user has already left the cold room, and in that case will be able to turn off the light from the outside by pressing the DOWN button, or alternatively is still working inside.

If, after first closing, the light is switched off manually (the user is outside the cold room), the controller resumes normal operation without waiting for the door to open a second time:

- the fans and/or compressors are switched on if called; when the compressor restarts the protection times must be observed ('c' parameters);
- the high temperature alarm is enabled after the delay Ad;
- the temperature stops flashing and the alarm icon (bell) goes off.

Opening the door the second time: status unchanged.

Closing the door the second time:

- the fans and/or compressors are switched on if called; when the compressor restarts the protection times must be observed ('c' parameters)
- the high temperature alarm is enabled after the delay Ad;
- the light is off if an output is configured as the light output (H1= 4).

4.10 Evaporator fan management parameters

The fan is activated based on the parameter settings and the status of the controller.

The evaporator fan control temperature is measured by probe 2, (connector 10).

To know which output is associated with the fan, see the wiring diagram for the "easy" model used (see par. "2.2 Electrical connections" page 11).

Important: these parameters are not available in the compact models.

In normal operation, the evaporator fan can be managed as follows:

- always on (F0= 0);
- on according to the evaporator temperature (F0= 1; F1);
- off when the compressor is off (F2= 1);
- activated in cyclical on/off mode (when the compressor is off - easy split only).

During defrost, the status of the evaporator fan is determined by parameter F3:

- controlled according to F0 (F3= 0);
- off (F3= 1).

The fan remains off:

- during the dripping period, if parameter dd≠0;
- during the post-dripping period, if parameter Fd≠0;
- for a time equal to c0 after instrument power-on, if parameter c0≠0.

F0: enable evaporator fan control

F0= 0 the fan is on;

F0= 1 the fan is controlled based on a set point (see parameter F1). If the evaporator probe is faulty, the fan operates.

F1: evaporator fan control set point

The controller starts the fans only when the temperature of the evaporator is below the value F1-A0. F1 is the real temperature value and not the deviation from the set point. Once off, the fans start again when the difference between the probe reading and the set point is equal to +A0, where A0 is the fan controller differential.

When F0= 1:

- evaporator temperature < F1 - A0, the fan is ON;
- evaporator temperature > F1, the fan is off.

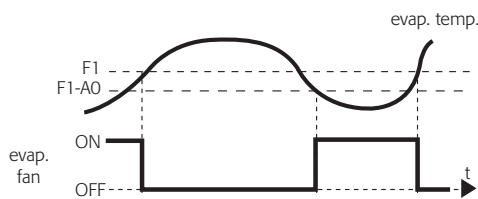

Fig. 4.m

F2: stop evaporator fans if compressor stops

F2= 0 the fan operates according to F0 even when the compressor is off;

F2= 1 the fan is off when the compressor is off;

F2=2 (easy split only): the fan is managed in cyclical on/off mode. The on and off times can be configured by parameters F4 and F5 respectively. The on and off sequence after control is deactivated starts with the ON phase, so as to exploit the fact that the evaporator is still cold.

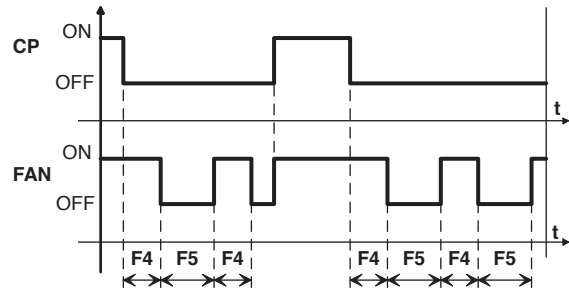

Fig. 4.n

Key

F4	Fan ON time	t	time
F5	Fan OFF time	FAN	fans
CP	Compressor		

F3: evaporator fan status during defrost

F3= 0 the fan is on during the defrost;

F3= 1 the fan is off during the defrost.

Fd: post-dripping time

The fans, after the defrost, can stay off for a further period (in minutes) beyond dd, defined by the value of Fd. This is useful to allow the evaporator to return to operating temperature after defrost, thus avoiding blowing "warm" air into the refrigerated environment.

If management by fan controller is selected, no time needs to be set for Fd as the controller starts the fans again when the evaporator has reached the correct temperature. If the fan controller is active (F0 = 1), setting to Fd a value ≠ 0, the fans remain off for a time equal to the value of Fd regardless of the evaporator temperature.

F4: fan ON time (with F2 = 2) (easy split only)

This parameter only has meaning when F2 = 2.

It defines the time expressed in minutes within the period (F4 + F5) during which the fans are on without being called.

F5: fan OFF time (with F2 = 2) (easy split only)

This parameter only has meaning when F2 = 2.

It defines the time expressed in minutes within the period (F4 + F5) during which the fans are off without being called.

4.11 Clock and time band parameters

The RTC (Real Time Clock), not available on the easy compact models, is used to manage the defrost function, curtain switch/night-time operation and AUX output in real time. The user can enable/disable the clock and set the current time using dedicated parameters.

In particular, up to 4 time bands can be set for managing the defrosts, one band for managing night-time operation and one for activating the AUX output.

The clock alarm fault "EtC" is activated only if the clock is effectively used, that is, has been enabled, the time has been set and there is at least one valid time band.

Setting the clock:

1. press the SET button for more than 3 s (if there are active alarms, first mute the buzzer) the display shows the parameter code "PS" (password);
2. press the SET button to access the password setting and use the UP and DOWN buttons to scroll the numbers until displaying "22" (password to access the configuration parameters);
3. press the SET button to confirm the password;
4. use the UP and DOWN buttons to scroll the names of the parameters until reaching the parameter tEn;
5. press SET to display the value associated with the parameter;
6. use the UP and DOWN buttons until reaching the value 1 for enabling the clock;
7. press SET to temporarily save the new value and display the parameter again;
8. repeat the operation to set the values of the parameters dAY (day of the week), hr (hours), Min (minutes). For easy split, also set YEr, Mon, dMo;
9. at the end of the operations, press the SET button for more than 3 seconds to permanently save the selected values and exit.

Setting the time bands:

Perform the operations from point 1 to point 7 above, then:

- select the parameter relating to the required band (e.g. d1d= DEFROST TIME BAND 1 DAY setting);
- press SET to display the status of the parameter;
- use the UP and DOWN buttons until reaching the desired value;
- press SET to temporarily save the new value and return to the previous display;
- repeat the operation to set the values of the parameters d1h (TIME BAND 1 HOUR setting), d1m (TIME BAND 1 MINUTES setting)
- at the end of the operations, press the SET button for more than 3 seconds to permanently save the selected values and exit.

RTC clock parameters

tEn	enable RTC (tEn=1 RTC enabled)
YEr	(easy split only): current year;
Mon	(easy split only): current month;
dMo	(easy split only): day of the month;
dAY:	current day of the week (1...7= Monday to Sunday);
hr	current hour (24 h)
Min	current minutes

Example: to set the current time and date to 15.07 on Thursday 3 May 2007, set:

tEn=1,
YEr=07, Mon=05, dMo=03 (easy split only)
dAY=4, hr=15, Min=7

The controller will save the time and the day of the week, month and year (on easy and easy compact controllers the month and year are ignored).



Note: the instrument does not manage automatic changeover to daylight saving.

Parameters for setting up to 4 defrost time bands

d1d...d4d	Defrost event day setting d1d...d4d=0 no defrost event d1d...d4d=1...7 Monday to Sunday d1d...d4d=8 from Monday to Friday d1d...d4d=9 from Monday to Saturday d1d...d4d=10 Saturday & Sunday d1d...d4d=11 every day
d1h...d4h	Defrost event hour setting (24h)
d1M...d4M	Defrost event minutes setting

Example: To program a defrost call (d1d) every Saturday & Sunday at 19.31, set: d1d=10 (days) d1h=19 (hours), d1M=31 (min).



Important: the defrost event only involves a defrost call. Whether the defrost is effectively run and the duration of the cycle depend on the status of the controller when the call is activated.

Parameters for setting the night-time set point time band

nOd	Night-time set point time band day setting nOd= 0 no event set nOd= 1...7 Monday to Sunday nOd= 8 from Monday to Friday nOd= 9 from Monday to Saturday nOd= 10 Saturday & Sunday nOd=11 every day
nOh	Night-time band set point start hours
nOM	Night-time band set point start minutes
nFd	Night-time band set point end day
nFh	Night-time band set point end hours
nFM	Night-time band set point end minutes

In easy split models, entering night time band involves the automatic modification of the set point and the light output (if H1=4)

Example: To program the night-time set point (nOd) every day from 12.31 to 13.29, set: nOd=11 (days), nOh=12 (start hours), nOM=31 (start minutes), nFh=13 (end hours) and nFM=29 (end minutes).

During night-time operation, the set point is varied: night-time set point = st +r4 (in direct mode), night-time set point = st -r4 (in reverse mode). Where featured, the protective curtain also closes the cabinet (A4=4).

Parameters for setting the AUX output activation time band

AOd	AUX output activation time band day setting AOd= 0 no event set AOd= 1...7 Monday to Sunday AOd= 8 from Monday to Friday AOd= 9 from Monday to Saturday AOd= 10 Saturday & Sunday AOd= 11 every day
AOh	AUX output activation time band start hours
AOM	AUX output activation time band start minutes
AFd	AUX output deactivation time band end day
AFh	AUX output activation time band end hours
AFM	AUX output activation time band end minutes

Example: To program the activation of the AUX output every day from 12.31 at 13.29, set: AOd=11 (days), AOH=12 (start hours), AOM=31 (start minutes), AFh=13 (end hours) and AFM=29 (end minutes).



Important: the activation the AUX output activation time band is linked to parameters H1=3 and A4≠6/7/8 and for easy split A4≠10,11.

4.12 Rapid parameter set selection (EZY)

The easy, easy compact and easy split controllers feature the EZY parameter (on the compact models, this is called EY), which is used to quickly choose a list of parameters, with corresponding values, for the control of the refrigeration system.

By setting parameter EZY=1, 2, 3, 4, one of the 4 lists made up of a maximum of 25 parameters (for the lists see par. "5.9 Table of EZY parameter sets" page 36). The values in the chosen list overwrite the corresponding operating parameters.

Note:

- to restore the selected rapid parameter set at any time, turn the controller off and on again, while holding SET. The display shows "CE" to indicate that the selected rapid set (EZY= 1, 2, 3, 4) has again overwritten the operating parameters, thus restoring the original set of parameters;
- to restore all the parameters and return to the original default values (factory settings), turn the controller off and on again while holding DOWN and SET, until the display shows "CF". Use this procedure with extreme care, as it may compromise the fundamental control settings;
- EZY=0 brings no change;
- on the thermometer models (PJEZM*), the EZY parameter (EY for the easy compact models) is not featured.

4.13 Other settings

The operation of the device is completed by a series of additional functions, such as the assignment of a supervisor serial network address, the configuration of the AUX relay, the enabling of the keypad and the buzzer.

H0: serial address

Assigns the instrument an identification address for connecting to a supervisory or telemaintenance system (def. H0=1).

H1: AUX output configuration

Establishes the operating logic of the auxiliary relay; in particular defines whether it is used as an alarm output or as an auxiliary output linked to the digital input. On easy split models there are also the light and second compressor outputs, with or without rotation.

- H1=0 no function associated with the output
- H1=1 alarm output: norm. energised (relay de-energised with alarm)
- H1=2 alarm output: norm. de-energised (relay energised with alarm)
- H1=3 AUX output related to Dig. in.
 - easy, easy compact : A4 = [6/7/8];
 - easy split: A4 = [6/7/8/10/11];
 - Dig. in. OPEN = AUX de-energised
 - Dig. in. CLOSED = AUX energised + LED "AUX" display"
- H1=4 light output (easy split only): the light can be switched on pressing the corresponding button from the keypad or when opening the door if the door switch is activated with light management (see parameter Ado)
- H1=5 second compressor output in parallel (easy split only): the output is activated a few seconds after the activation of the first compressor (delay = c11). The second compressor observes the protection times c0, c1, c2, c3 for the first compressor;
- H1=6 second compressor output with two step control without rotation (easy split only): the second compressor is called when the temperature measured by the room probe deviates by more than half the differential (rd/2) from the set point;

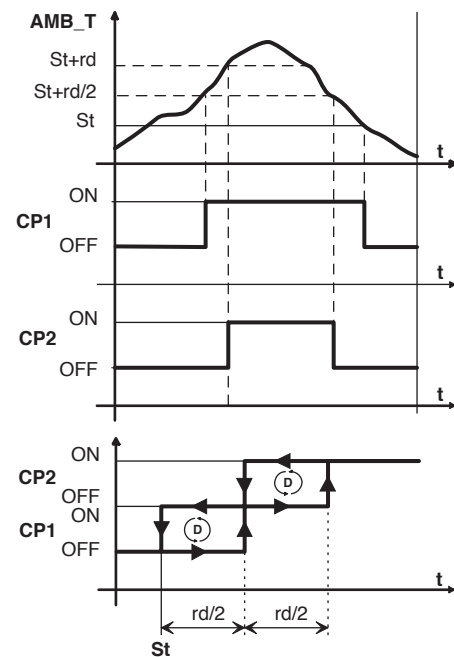

Fig. 4.o

AMB_T	Control probe	CP2	Compressor 2
CP1	Compressor 1	rd	Differential
t	time	St	Set point

H1=7 second compressor output with two step control with rotation (easy split only). The roles of main and secondary compressor alternate following each shutdown, so that when next started (stopped) the output not involved in the previous start (stop). will be activated (deactivated). Both the compressors must observe the protection times c0, c1, c2 and c3.

Examples of operation:

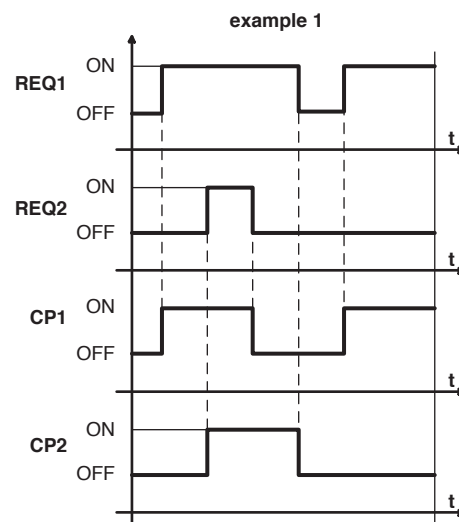

Fig. 4.p

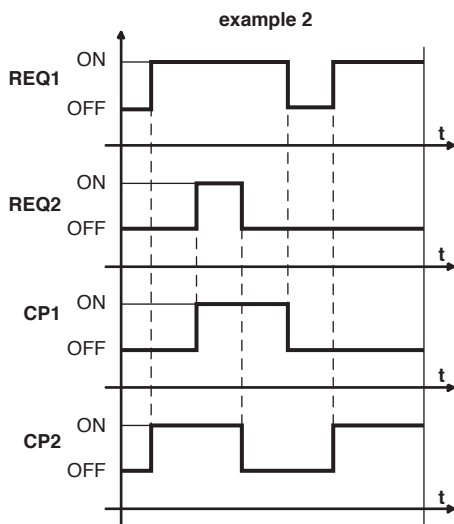

Fig. 4.q

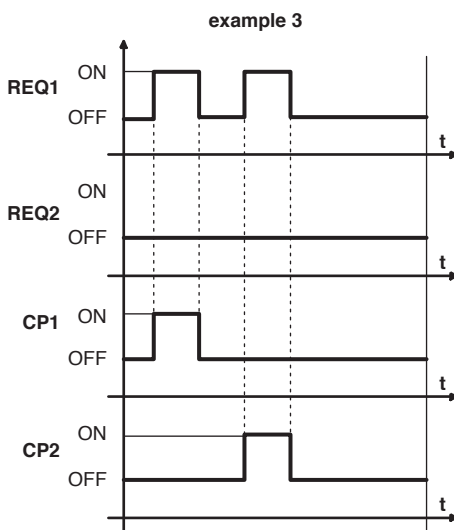

Fig. 4.r

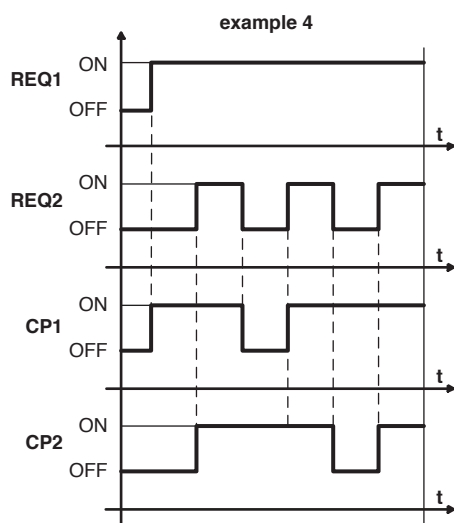

Fig. 4.s

Key
 REQ1 Compressor 1 call CP1 Compressor 1
 REQ2 Compressor 2 call CP2 Compressor 2
 t time



Note:

- in mode H1= 1/2, the alarms that act on the AUX output are: "LO", "HI", "EO", "IA", "CHT";
- mode H1= 1 is useful for signalling an alarm when a power failure occurs

H2: enable keypad

Used to prevent the set point and the other operating parameters from being changed when the instrument is located in a place that is accessible to the public.

- H2= 0 keypad disabled:
 - F parameters read-only
 - C parameters modifiable (with password)
 - no set point modification
 - no manual defrost
 - no continuous cycle
 - no ON/OFF
- H2=1 keypad enabled
- H2=2 keypad enabled except for ON/OFF

H4: disable buzzer

Setting H4= 1 disables the operation of the audible buzzer.

H5: ID code

Display-only value: this can only be modified via serial connection (key or supervisor). When set to a positive value (values from 0 to 31 are used by CAREL for the basic models), if a parameter, including the set point, is modified from the keypad, the value becomes negative. This allows any modifications made the parameters compared to the initial settings to be monitored.

H6: select control associated with UP + DOWN buttons (easy split only)

The following values are allowed:

- H6 = 0: start/stop continuous cycle;
- H6 = 1: start/stop defrost.

H7: management of fourth relay/serial communication (easy split only)

This parameter is used to enable the fourth relay output (RL4). In models with four relays, management of the fourth relay and serial communication are mutually exclusive.

- H7 = 0: fourth relay disabled and serial communication enabled;
 - H7 = 1: fourth relay enabled and serial communication disabled.
- (see paragraph "2.3 Wiring diagram for multiple units" page 13).

PS: password

Protection code for modifying the configuration parameters (default= 22). The value of the password can be customised from the supervisor.

HMP: Maximum maintenance interval (easy split only)

This function requires the internal clock (RTC) to be enabled (tEn=1). If HMP = 0, the maintenance request is deactivated. Parameter HMP, expressed in days, is used to set the maximum time interval after which the controller generates a maintenance request (the counter HMD has exceeded the threshold HMP), which involves a message shown on the display (SrC) and the alarm icon on. The signal can be deactivated by setting parameter HMr = 1 from the keypad or supervisor. This operation saves the current date and restarts the counter HMD.

HMD: Days elapsed since last maintenance (easy split only)

Read-only parameter. See the explanation of parameter HMP.

HMr: reset maintenance signal and restart HMD (easy split only)

If set to 1, this deactivates the signal SrC and restarts the counter HMD. Operation available from the keypad and supervisor.

5. TABLES OF ALARMS AND PARAMETERS

5.1 Table of alarms and signals

When an alarm is activated, the display shows the corresponding message that flashes alternating with the temperature; if fitted and enabled, the buzzer and the alarm relay are also activated.

All the alarms have automatic reset (that is, they stop when the causes are no longer present), except for alarm 'CHt' which has manual reset (instrument on/off using the UP button or by disconnecting the power supply). Pressing the SET button mutes the buzzer, while the code displayed and the alarm relay only go off when the causes of the alarm have been resolved. The alarm codes are shown in the table below:

The possible alarm codes are shown in the following table:

alarm code	buzzer and alarm relay	LED	alarm description	reset	ENABLE ALARM parameters involved	easy	easy compact	easy split
E0	active	ON	probe 1 error= control	automatic	-	✓	✓	✓
E1	not active	ON	probe 2 error= defrost	automatic	d0= 0 / 1 / 4, F0= 1	✓	✓	✓
E2	not active	ON	probe 3 error= condenser/product	automatic	easy, easy compact [A4=10/11] easy split [A4=13/14]	✓	-	✓
IA	active	ON	external alarm	automatic	[A4 = 1] [+A7]	✓	-	✓
dOr	active	ON	open door alarm	automatic	easy, easy compact [A4=7/8][+A7] easy split [A4=7/8/10/11][+A7]	✓	-	✓
LO	active	ON	low temperature alarm	automatic	[AL] [Ad]	✓	✓	✓
HI	active	ON	high temperature alarm	automatic	[AH] [Ad]	✓	✓	✓
EE	not active	ON	unit parameter error	not possible	-	✓	✓	✓
EF	not active	ON	operating parameter error	manual	-	✓	✓	✓
Ed	not active	ON	defrost ended by timeout	on first defrost ended correctly	[dP] [dt] [d4] [A8]	✓	✓	✓
dF	not active	OFF	defrost running	automatic	[d6=0]	✓	✓	✓
cht	not active	ON	dirty condenser pre-alarm	automatic	easy, easy compact [A4=10] easy split [A4=13]	✓	-	✓
CHt	active	ON	dirty condenser alarm	manual	easy, easy compact [A4=10] easy split [A4=13]	✓	-	✓
EtC	not active	ON	clock alarm	by setting the time	if bands are active	✓	-	✓
SrC (easy split only)	not active	ON	maintenance request signal	manual, set HMr=1	[HMP] [HMd] [HMr]	-	-	✓

Table 5.a

5.2 Description of the main signals and alarms

LED flashing

The activation of the corresponding function is delayed by a timer, awaiting an external signal or disabled by another procedure that is already in progress. e.g. if is a continuous cycle in progress and a defrost is called, the latter will remain pending until the end of the continuous cycle, and the corresponding LED (defrost) will flash.

E0 steady or flashing

control probe error:

- probe not working: the probe signal is interrupted or short-circuited;
- probe not compatible with the instrument;

The alarm signal E0 is steady if it is the only active alarm (the temperature value is not displayed), while it flashes if other alarms are active or the second probe is displayed.

E1 flashing

evaporator probe or food conservation probe error:

- probe not working, the probe signal is interrupted or short-circuited;
- probe not compatible with the instrument;

E2 flashing

condenser probe or food conservation probe error:

- probe not working, the probe signal is interrupted or short-circuited;
- probe not compatible with the instrument;



Note: in easy split controllers, when starting control (powering up the controller and/or switching from OFF status), the high temperature alarm signal is disabled until the first time the compressor stops, to avoid false signals. The first time the compressor stops indicates that the set temperature has been reached, and, consequently, the high temperature alarm signal is enabled. This function is always active.

IA flashing

immediate or delayed alarm from multifunction digital input:

- check the multifunction input and parameters A4 and A7.

dOr flashing

open door alarm:

- check the multifunction input and parameters A4 and A7.

LO flashing

low temperature alarm. The probe has measured a temperature lower than the set point by a value that exceeds parameter AL:

- check parameters AL, Ad and A0.

The alarm is automatically reset when the temperature returns within the set limits (see parameter AL).

HI flashing

high temperature alarm. The probe has measured a temperature higher than the set point by a value that exceeds parameter AH.

- check parameters AH, Ad and A0.

The alarm is automatically reset when the temperature returns within the set limits (see parameter AH).

EE displayed during operation or on power-up

unit parameter reading error. See Data errors.

EF displayed during operation or on power-up
operating parameter reading error. See Data errors.

Ed flashing

The last defrost ended after exceeding the maximum duration rather than when reaching the end defrost set point.

- check parameters dt, dP and d4;
- check the efficiency of the defrost.

The message disappears when the next defrost ends correctly.

dF flashing

defrost running:

- this is not an alarm signal, but rather a message that the instrument is running a defrost. Only shown if d6=0.

cht flashing

dirty condenser pre-alarm:

- check parameters A4, Ac, AE and Acd.

CHt flashing

dirty condenser alarm:

- check parameters A4, Ac, AE and Acd.

EtC flashing

internal clock error.

SrC flashing (easy split only)

Maintenance request signal. Displayed only if parameter HMP≠0.

5.3 Data error

In certain operating conditions, the instrument may detect errors in the data saved. These errors may compromise the correct operation of the instrument. If the microprocessor detects a data saving error, the display shows the message "EE".

If the fault persists, the controller needs to be replaced. If, on the other hand, the message disappears, it can continue to be used. When "EE" error occurs frequently and/or remains for some time, the controller should be checked, as the original precision may not be guaranteed.

5.4 Modifying the parameters

Parameter navigation

The operating parameters, modifiable using the keypad, are divided into two types: frequent (type F) and configuration (type C). Access to the latter is protected by password (default= 22) to prevent accidental or unauthorised modifications.

Accessing the type F parameters:

- press the SET button for more than 3 s (if there are active alarms, mute the buzzer). The display shows the parameter code 'PS' (password);
- use the UP and DOWN buttons to scroll the parameters. The LED corresponding to the category of parameters will be on (see Table 5.b);
- press SET to display the value associated with the parameter
- increase or decrease the value using the UP or DOWN button respectively;
- press SET to temporarily save the new value and display the parameter again;
- repeat the procedure for any other parameters that need to be modified;
- press the SET button for more than 3 s to permanently save the parameters and exit the parameter setting procedure.

Accessing the type C parameters:

- press the SET button for more than 3 s (if there are active alarms, mute the buzzer), the display shows the parameter code "PS" (password);
- press the SET button to access the password setting;
- use the UP and DOWN buttons to scroll the numbers until displaying "22" (password to access the parameters);
- press the SET button to confirm the password;
- use the UP and DOWN buttons to scroll the parameters. The LED corresponding to the category of parameters will be on (see Table 5.b);
- press SET to display the value associated with the parameter;
- increase or decrease the value using the UP or DOWN button respectively;
- press SET to temporarily save the new value and display the parameter again;
- repeat the procedure for any other parameters that need to be modified;
- press the SET button for more than 3 s to permanently save the parameters and exit the parameter setting procedure.

Warnings:

if no button is pressed for 60 s, all the changes made to the parameters, temporarily saved in the RAM, will be cancelled and the previous settings restored.

The dAY, hr, Min dMo*, Mom*, YEr* parameters are not restored, as these are saved instantly when entered(*= easy split only).

If power is disconnected from the instrument before saving the settings (pressing the SET button for 3 s), all the changes made to the parameters and temporarily saved will be lost.

Category	Initial	Icon
Probe parameters	/	-
Control parameters	r	-
Compressor parameters	c	
Defrost parameters	d	
Alarm parameters	A	
Fan parameters	F	
AUX output configuration parameters	H1	AUX
RTC parameters	-	

Table 5.b

5.5 Setting the default parameters

Warnings:

running this procedure overwrites any custom parameter settings.

To reset the default parameters:

- disconnect power from the instrument;
- reconnect power while holding the SET and DOWN buttons;
- the display will show the message "CF";
- after a few seconds the instrument starts operating with the default configuration. Any different parameter settings will need to be updated.

5.6 Table of easy parameters

Par.	Description	Type	Min	Max	UOM.	Def.	Parameter visible in models
PS	password	F	0	200	-	22	M/S (with 1 & 2 probes), X, Y, C
/2	probe measurement stability	C	1	15	-	4	M/S (with 1 & 2 probes), X, Y, C
/4	select probe displayed	F	1	3	-	1	M/S (with 2 probes), X, Y, C
/5	select °C/°F	C	0(°C)	1(°F)	-	0	M/S (with 1 & 2 probes), X, Y, C
/6	disable decimal point	C	0	1	-	0	M/S (with 1 & 2 probes), X, Y, C
/7	enable probe 2 alarm (model M only)	C	0	1	-	0	M
/C1	probe 1 offset	F	-50.0	50.0	(°C/°F)	0	M/S (with 1 & 2 probes), X, Y, C
/C2	probe 2 offset	F	-50.0	50.0	(°C/°F)	0	M/S (with 2 probes), X, Y, C
/C3	probe 3 offset	F	-50.0	50.0	(°C/°F)	0	M/S (with 2 probes), X, Y, C
St	set point	S	r1	r2	°C/°F	4	M/S (with 1 & 2 probes), X, Y, C
rd	control differential	F	0	19.0	°C/°F	2	S (with 1 & 2 probes), X, Y, C
r1	minimum set point value	C	-50	r2	°C/°F	-50	M/S (with 1 & 2 probes), X, Y, C
r2	maximum set point value	C	r1	200	°C/°F	90	S (with 1 & 2 probes), X, Y, C
r3	select direct/reverse operation	C	0	2	-	0	M/S (with 2 probes), X, Y, C
r4	night-time set point delta	C	-50	50	°C/°F	3	S (with 1 & 2 probes), X, Y, C
c0	compressor and fan start delay on power-up	C	0	100	min	0	S (with 1 & 2 probes), X, Y, C
c1	minimum time between consecutive compressor starts	C	0	100	min	0	S (with 1 & 2 probes), X, Y, C
c2	minimum compressor off time	C	0	100	min	0	S (with 1 & 2 probes), X, Y, C
c3	minimum compressor on time	C	0	100	min	0	S (with 1 & 2 probes), X, Y, C
c4	compressor on time with duty setting	C	0	100	min	0	S (with 1 & 2 probes), X, Y, C
cc	continuous cycle duration	C	0	15	h	4	S (with 1 & 2 probes), X, Y, C
c6	temperature alarm bypass after continuous cycle	C	0	15	h	2	S (with 1 & 2 probes), X, Y, C
d0	type of defrost	C	0	4	-	0	S (with 1 & 2 probes), X, Y, C
dl	interval between defrosts	F	0	199	h/min (see dC)	8	S (with 1 & 2 probes), X, Y, C
dt	end defrost temperature set point/defrost temperature threshold with temp. control	F	-50	130	°C/°F	4	S (with 2 probes), X, Y, C
dP	maximum defrost duration	F	1	199	min/s (see dC)	30	S (with 1 & 2 probes), X, Y, C
d4	defrost when switching the instrument on	C	0	1	-	0	S (with 1 & 2 probes), X, Y, C
d5	defrost delay on power-up or when enabled by digital input	C	0	199	min	0	S (with 1 & 2 probes), X, Y, C
d6	freeze control temperature display during defrost	C	0	1	-	1	S (with 1 & 2 probes), X, Y, C
dd	dripping time	F	0	15	min	2	S (with 1 & 2 probes), X, Y, C
d8	alarm bypass time after defrost	F	0	15	h	1	S (with 1 & 2 probes), X, Y, C
d9	defrost priority over compressor protectors	C	0	1	-	0	S (with 1 & 2 probes), X, Y, C
d/	defrost probe reading (2)	F	-	-	°C/°F	-	S (with 2 probes), X, Y, C
dC	time base	C	0	1	-	0	S (with 1 & 2 probes), X, Y, C
A0	alarm and fan temperature differential	C	-20	20.0	°C/°F	2	M/S (with 1 & 2 probes), X, Y, C
AL	absolute/relative temperature for low temperature alarm	F	-50	250	°C/°F	0	M/S (with 1 & 2 probes), X, Y, C
AH	absolute/relative temperature for high temperature alarm	F	-50	250	°C/°F	0	M/S (with 1 & 2 probes), X, Y, C
Ad	temperature alarm delay	C	0	199	min	0	M/S (with 1 & 2 probes), X, Y, C
A4	3rd input configuration	C	0	11	-	0	M/S (with 2 probes), X, Y, C
A7	digital input alarm delay	C	0	199	min	0	M/S (with 2 probes), X, Y, C
A8	enable alarm "Ed" (end defrost by timeout)	C	0	1	-	0	S (with 2 probes), X, Y, C
Ac	set point dirty condenser alarm	C	-50	250	°C/°F	70	M/S (with 2 probes), X, Y, C
AE	dirty condenser alarm differential temperature	C	0.1	20.0	°C/°F	5.0	M/S (with 2 probes), X, Y, C
AcD	dirty condenser alarm delay	C	0	250	min	0	M/S (with 2 probes), X, Y, C
F0	enable evaporator fan control	C	0	1	-	0	C
F1	evaporator fan control set point	F	-50	130	°C/°F	+5	C
F2	stop evaporator fan if compressor off	C	0	1	-	1	C
F3	evaporator fan status during defrost	C	0	1	-	1	C
Fd	post-dripping time	F	0	15	min	1	C
H0	serial address	C	0	207	-	1	M/S (with 1 & 2 probes), X, Y, C
H1	AUX output configuration	C	0	3	-	0	M/S (with 1 & 2 probes), X, Y, C
H2	enable keypad	C	0	1	-	1	M/S (with 1 & 2 probes), X, Y, C
H4	disable buzzer	C	0	1	-	0	M/S (with 1 & 2 probes), X, Y, C
H5	ID code (read-only)	F	0	199	-	-	M/S (with 1 & 2 probes), X, Y, C
EZY	rapid parameter set selection	C	0	4	-	0	S (with 1 & 2 probes), X, Y, C
tEn	enable RTC	C	0	1	-	0	X, Y, C (*)
d1d	defrost time band 1st day	C	0	11	days	0	X, Y, C (*)
d1h	time band 1st hour	C	0	23	h	0	X, Y, C (*)
d1M	time band 1st minute	C	0	59	min	0	X, Y, C (*)
d2d	defrost time band 2nd day	C	0	11	days	0	X, Y, C (*)
d2h	time band 2nd hour	C	0	23	h	0	X, Y, C (*)
d2M	time band 2nd minute	C	0	59	min	0	X, Y, C (*)
d3d	defrost time band 3rd day	C	0	11	days	0	X, Y, C (*)
d3h	time band 3rd hour	C	0	23	h	0	X, Y, C (*)
d3M	time band 3rd minute	C	0	59	min	0	X, Y, C (*)
d4d	defrost time band 4th day	C	0	11	days	0	X, Y, C (*)
d4h	time band 4th hour	C	0	23	h	0	X, Y, C (*)
d4M	time band 4th minute	C	0	59	min	0	X, Y, C (*)
nOd	night time band ON day	C	0	11	days	0	X, Y, C (*)
nOh	night time band ON hours	C	0	23	h	0	X, Y, C (*)
nOM	night time band ON minutes	C	0	59	min	0	X, Y, C (*)
nFd	night time band OFF day	C	0	11	days	0	X, Y, C (*)
nFh	night time band OFF hours	C	0	23	h	0	X, Y, C (*)
nFM	night time band OFF minutes	C	0	59	min	0	X, Y, C (*)
AOd	AUX time band ON day	C	0	11	days	0	X, Y, C (*)
AOh	AUX time band ON hours	C	0	23	h	0	X, Y, C (*)
AOM	AUX time band ON minutes	C	0	59	min	0	X, Y, C (*)

Par.	Description	Type	Min	Max	UOM.	Def.	Parameter visible in models
AFd	AUX time band OFF day	C	0	11	days	0	X, Y, C (*)
AFh	AUX time band OFF hours	C	0	23	h	0	X, Y, C (*)
AFM	AUX time band OFF minutes	C	0	59	min	0	X, Y, C (*)
dAY	RTC day of the week	C	1	7	days	1	X, Y, C (*)
hr	RTC hours	C	0	23	h	0	X, Y, C (*)
Min	RTC minutes	C	0	59	min	0	X, Y, C (*)

Table 5.c

(*) Parameters not visible in models without RTC

5.7 Table of easy compact parameters

Par.	Description	Type	Min	Max	UOM.	Def.	Parameter visible in models
PS	password	F	0	99	-	22	S (with 1 & 2 probes), M (with 1 & 2 probes)
/2	probe measurement stability	C	1	15	-	4	S (with 1 & 2 probes), M (with 1 & 2 probes)
/4	select probe displayed	F	1	2	-	1	S (with 2 probes), M (with 2 probes).
/5	select °C/°F	C	0	1	-	0	S (with 1 & 2 probes), M (with 1 & 2 probes)
/6	disable decimal point	C	0	1	-	0	S (with 1 & 2 probes), M (with 1 & 2 probes)
/7	enable probe 2 alarm (model M only)	C	0	1	0	0	M
/C1	probe 1 offset	F	-50.0	50.0	°C/°F	0	S (with 1 & 2 probes), M (with 1 & 2 probes)
/C2	probe 2 offset	F	-50.0	50.0	°C/°F	0	S (with 2 probes), M (with 2 probes)
St	set point	S	r1	r2	°C/°F	4	S (with 1 & 2 probes), M (with 1 & 2 probes)
rd	control differential	F	0	19.0	°C/°F	2	S (with 1 & 2 probes)
r1	minimum set point value	C	-50.0	r2	°C/°F	-50	S (with 1 & 2 probes), M (with 1 & 2 probes)
r2	maximum set point value	C	r1	99	°C/°F	90	S (with 1 & 2 probes), M (with 1 & 2 probes)
r3	select direct/reverse operation	C	0	2	-	0	S (with 1 & 2 probes)
c0	compressor and fan start delay on power-up	C	0	100	min	0	S (with 1 & 2 probes)
c1	minimum time between consecutive compressor starts	C	0	100	min	0	S (with 1 & 2 probes)
c2	minimum compressor off time	C	0	100	min	0	S (with 1 & 2 probes)
c3	minimum compressor on time	C	0	100	min	0	S (with 1 & 2 probes)
c4	compressor on time with duty setting	C	0	100	min	0	S (with 1 & 2 probes)
cc	continuous cycle duration	C	0	15	h	4	S (with 1 & 2 probes)
c6	temperature alarm bypass after continuous cycle	C	0	15	h	2	S (with 1 & 2 probes)
d0	type of defrost	C	0	4	-	0	S (with 1 & 2 probes)
dl	interval between defrosts	F	0	199	h/min(dC)	8	S (with 1 & 2 probes)
dt	end defrost temperature set point	F	-50	130	°C/°F	4	S (with 2 probes)
dP	maximum defrost duration	F	1	199	min/s (dC)	30	S (with 1 & 2 probes)
d4	defrost when switching the instrument on	C	0	1	-	0	S (with 1 & 2 probes)
d5	defrost delay on power-up or when enabled by digital input	C	0	199	min	0	S (with 1 & 2 probes)
d6	freeze control temperature display during defrost	C	0	1	-	1	S (with 1 & 2 probes)
dd	dripping time	F	0	15	min	2	S (with 1 & 2 probes)
d8	alarm bypass time after defrost	F	0	15	h	1	S (with 1 & 2 probes)
d9	defrost priority over compressor protectors	C	0	1	-	0	S (with 1 & 2 probes)
d/	defrost probe reading (2)	F	-	-	°C/°F	-	S (with 2 probes)
dC	time base	C	0	1	-	0	S (with 1 & 2 probes)
A0	alarm and fan temperature differential	C	-20	+20	°C/°F	2	S (with 1 & 2 probes)
AL	absolute/relative temperature for low temperature alarm	F	-50	+99	°C/°F	0	S (with 1 & 2 probes)
AH	absolute/relative temperature for high temperature alarm	F	-50	+99	°C/°F	0	S (with 1 & 2 probes)
Ad	temperature alarm delay	C	0	199	min	0	S (with 1 & 2 probes)
A8	enable alarm "Ed" (end defrost by timeout)	C	0	1	-	0	S (with 2 probes)
H0	serial address	C	0	207	-	1	S (with 1 & 2 probes), M (with 1 & 2 probes)
H1	AUX output configuration	C	0	2	-	0	S (with 1 & 2 probes), M (with 1 & 2 probes)
H2	enable keypad	C	0	2	-	1	S (with 1 & 2 probes), M (with 1 & 2 probes)
H5	ID code (read-only)	F	1	+199	-	0	S (with 1 & 2 probes), M (with 1 & 2 probes)
EY	rapid parameter set selection	C	0	4	-	0	S (with 1 & 2 probes)

Table 5.d

 **Warning** the easy compact models only display two digits. If the range is below -99 and above 99, the terminal will display "- -".

5.8 Table of easy split parameters

Par.	Description	Type	Min	Max	UOM	Def.	Visibility
/P5	password	F	0	200	-	22	S,C
/2	probe measurement stability	C	1	15	-	4	S,C
/3	probe display rate	C	0	15	-	0	S,C
/4	select probe displayed	F	1	3	-	1	S,C
/5	select °C/°F	C	0	1	-	0	S,C
/6	disable decimal point	C	0	1	-	0	S,C
/C1	probe 1 offset	F	-50	50	(°C/°F)	0	S,C
/C2	probe 2 offset	F	-50	50	(°C/°F)	0	S,C
/C3	probe 3 offset	F	-50	50	(°C/°F)	0	S,C
/P	select type of probe	C	0	1	-	0	S,C
St	set point	F	r1	r2	°C/°F	4	S,C
rd	differential	F	0	19	°C/°F	2	S,C
r1	minimum set point value	C	-50	r2	°C/°F	-50	S,C
r2	maximum set point value	C	r1	300	°C/°F	90	S,C
r3	select direct/reverse operation	C	0	2	-	0	S,C
r4	night-time set point delta	C	-50	+50	°C/°F	3	S,C
c0	compressor and fan start delay on power-up	C	0	100	min	0	S,C
c1	minimum time between consecutive compressor starts	C	0	100	min	0	S,C
c2	minimum compressor off time	C	0	100	min	0	S,C
c3	minimum compressor on time	C	0	100	min	0	S,C
c4	compressor on time with duty setting	C	0	100	min	0	S,C
cc	continuous cycle duration	C	0	15	h	4	S,C
c6	temperature alarm bypass after continuous cycle	C	0	15	h	2	S,C
c11	second compressor delay	C	0	250	s	4	S,C
d0	type of defrost	C	0	4	-	0	S,C
d1	interval between defrosts	F	0	199	h/min (see dC)	8	S,C
dt	end defrost temperature set point/defrost temperature threshold with temp. control	F	-50	300	°C/°F	4	S,C
dP	maximum defrost duration	F	1	199	min/s	30	S,C
d4	defrost when switching the instrument on	C	0	1	-	0	S,C
d5	defrost delay on power-up or when enabled by digital input	C	0	199	min	0	S,C
d6	freeze control temperature display during defrost	C	0	1	-	1	S,C
dd	dripping time	F	0	15	min	2	S,C
d8	alarm bypass time after defrost	F	0	15	h	1	S,C
d9	defrost priority over compressor protectors	C	0	1	-	0	S,C
d/	defrost probe reading	F	-	-	°C/°F	-	S,C
dC	time base	C	0	1	-	0	S,C
A0	alarm and fan temperature differential	C	-20	20	°C/°F	2	S,C
AL	absolute/relative temperature for low temperature alarm	F	-50	300	°C/°F	0	S,C
AH	absolute/relative temperature for high temperature alarm	F	-50	300	°C/°F	0	S,C
Ad	temperature alarm delay	C	0	199	min	0	S,C
A4	3rd input configuration	C	0	14	-	0	S,C
A7	digital alarm input delay	C	0	199	min	0	S,C
A8	enable alarm "Ed" (end defrost by timeout)	C	0	1	-	0	S,C
Ac	dirty condenser alarm set point	C	-50	300	°C/°F	70	S,C
AE	dirty condenser alarm differential temperature	C	0.1	20.0	°C/°F	5	S,C
Acd	dirty condenser alarm delay	C	0	250	min	0	S,C
Ado	door management algorithm	C	0	1	-	0	S,C
F0	enable evaporator fan control	C	0	1	-	0	C
F1	evaporator fan control set point	F	-50	300	°C/°F	5	C
F2	stop evaporator fan if compressor off	C	0	2	-	1	C
F3	evaporator fan status during defrost	C	0	1	-	1	C
Fd	post-dripping time	F	0	15	min	1	C
F4	fan ON time (when F2=2)	C	0	100	min	5	C
F5	fan OFF time (when F2=2)	C	0	100	min	10	C
H0	serial address	C	0	207	-	1	S,C
H1	AUX output configuration	C	0	7	-	4	S,C
H2	enable keypad	C	0	2	-	1	S,C
H4	disable buzzer	C	0	1	-	0	S,C
H5	ID code (read-only)	F	1	199	-	0	S,C
H6	select control associated with UP + DOWN buttons	C	0	1	-	1	S,C
H7	management of fourth relay/serial communication	C	0	1	-	1	C
EZY	rapid parameter set selection	C	0	4	-	0	S,C
tEn	enable RTC	C	0	1	-	0	S,C (*)
d1d	defrost time band 1st day	C	0	11	day	0	S,C (*)
d1h	time band 1st hour	C	0	23	h	0	S,C (*)
d1M	time band 1st minutes	C	0	59	min	0	S,C (*)
d2d	defrost time band 2nd day	C	0	11	day	0	S,C (*)
d2h	time band 2nd hours	C	0	23	h	0	S,C (*)
d2M	time band 2nd minutes	C	0	59	min	0	S,C (*)
d3d	defrost time band 3rd day	C	0	11	day	0	S,C (*)
d3h	time band 3rd hours	C	0	23	h	0	S,C (*)
d3M	time band 3rd minutes	C	0	59	min	0	S,C (*)
d4d	defrost time band 4th day	C	0	11	day	0	S,C (*)
d4h	time band 4th hours	C	0	23	h	0	S,C (*)
d4M	time band 4th minutes	C	0	59	min	0	S,C (*)
nOd	night time band ON day	C	0	11	day	0	S,C (*)
nOh	night time band ON hours	C	0	23	h	0	S,C (*)
nOM	night time band ON minutes	C	0	59	min	0	S,C (*)
nFd	night time band OFF day	C	0	11	day	0	S,C (*)

Par.	Description	Type	Min	Max	UOM	Def.	Visibility
nFh	night time band OFF hours	C	0	23	h	0	S,C (*)
nFM	night time band OFF minutes	C	0	59	min	0	S,C (*)
AOd	AUX time band ON day	C	0	11	day	0	S,C (*)
AOh	AUX time band ON hours	C	0	23	h	0	S,C (*)
AOM	AUX time band ON minutes	C	0	59	min	0	S,C (*)
AFd	AUX time band OFF day	C	0	11	day	0	S,C (*)
AFh	AUX time band OFF hours	C	0	23	h	0	S,C (*)
AFM	AUX time band OFF minutes	C	0	59	min	0	S,C (*)
YEr	RTC: year	C	0	99	year	0	S,C (*)
Mon	RTC: month	C	1	12	month	1	S,C (*)
dMo	RTC: day of the month	C	1	31	day	1	S,C (*)
dAY	RTC: day of the week	C	1	7	day	1	S,C (*)
hr	RTC: hours	C	0	23	h	0	S,C (*)
MIn	RTC: minutes	C	0	59	min	0	S,C (*)
HMP	maximum maintenance interval	C	0	999	day	0	S,C (*)
HMd	days elapsed since last maintenance	C	0	999	day	0	S,C (*)
HMr	reset maintenance signal and restart HMD	F	0	1	-	0	S,C (*)

Table 5.e

(*) Parameters not visible in models without RTC

5.9 Table of EZY parameter sets

easy parameter sets (EZY)

Par.	Description	models S-X (normal temperature)				models Y-C (low temperature)			
		EZY=1	EZY=2	EZY=3	EZY=4	EZY=1	EZY=2	EZY=3	EZY=4
/4	select probe displayed	1	1	1	1	-	-	-	-
/5	select °C/°F	0	0	0	0	-	-	-	-
rd	control differential	3.0	3.0	5.0	2.0	3.0	4.0	5.0	2.0
r1	minimum set point value	-10.0	-15.0	-20.0	-30.0	-30.0	-30.0	-30.0	-30.0
r2	maximum set point value	15.0	20.0	20.0	40.0	20.0	20.0	30.0	40.0
r3	select direct/reverse operation	1	0	2	0				
r4	night-time set point delta	-	-	-	-	5.0	5.0	2.0	4.0
c1	minimum time between consecutive compressor starts	3	5	0	6	4	5	3	6
c2	minimum compressor off time	2	4	0	4	2	3	0	5
d0	type of defrost	2	2	0	4	1	2	3	4
dl	interval between defrosts	6	10	6	12	5	7	10	12
dt	end defrost temperature set point/defrost temperature threshold with temp. control	5.0	5.0	5.0	5.0	5.0	5.0	5.0	4.0
dP	maximum defrost duration	40	40	40	40	20	40	10	50
d6	freeze control temperature display during defrost	1	1	1	1	-	-	-	-
dC	time base	0	0	0	0	0	0	0	0
A0	alarm and fan temperature differential	2.0	2.0	2.0	2.0	2.0	2.0	2.0	2.0
AL	temperature alarm threshold/deviation	20.0	25.0	20.0	20.0	22.0	15.0	18.0	20.0
AH	high temperature alarm threshold/deviation	20.0	25.0	20.0	20.0	22.0	25.0	20.0	25.0
Ad	temperature alarm delay	60	70	60	60	20	40	30	25
A4	3rd input configuration	-	-	-	-	0	4	1	0
A7	digital input alarm delay	-	-	-	-	0	20	30	20
Ac	set point dirty condenser alarm	55.0	50.0	70.0	55.0	55.0	55.0	55.0	55.0
AE	dirty condenser alarm differential temperature	10.0	8.0	10.0	10.0	10.0	10.0	10.0	10.0
Acd	dirty condenser alarm delay	60	40	200	60	60	60	60	60
F0	enable evaporator fan control	-	-	-	-	1	0	1	0
F1	evaporator fan control set point	-	-	-	-	5.0	5.0	5.0	5.0
F2	stop evaporator fan if compressor off	-	-	-	-	1	1	1	1
F3	evaporator fan status during defrost	-	-	-	-	1	1	1	1
Fd	post-dripping time	-	-	-	-	3	4	5	6

Table 5.f

Key:

EZY=	normal temperature	low temperature
1	no defrost	defrost by hot gas
2	defrost by time	automatic night-time set point variation from digital input
3	heating output (reverse)	digital input alarm management
4	defrost with temp. control (d0= 4)	defrost by temperature (d0=4)

easy compact parameter sets (EY)

Par.	Description	S models (normal temperature)			
		EY=1	EY=2	EY=3	EY=4
/4	select probe displayed	1	1	1	1
/5	select °C/°F	0	0	0	0
rd	control differential	3.0	3.0	5.0	2.0
r1	minimum set point value	-10.0	-15.0	-20.0	-30.0
r2	maximum set point value	15.0	20.0	20.0	40.0
r3	select direct/reverse operation	1	0	2	0
c1	minimum time between consecutive compressor starts	3	5	0	6
c2	minimum compressor off time	2	4	0	4
d0	type of defrost	2	2	0	4
dl	interval between defrosts	6	10	6	12
dt	end defrost temperature set point	5.0	5.0	5.0	5.0
dP	maximum defrost duration	40	40	40	40
d6	freeze control temperature display during defrost	1	1	1	1
dC	time base	0	0	0	0
A0	alarm and fan temperature differential	2.0	2.0	2.0	2.0
AL	absolute temperature or deviation for low temperature alarm	20.0	25.0	20.0	20.0
AH	absolute temperature or deviation for high temperature alarm	20.0	25.0	20.0	20.0
Ad	temperature alarm delay	60	70	60	60

Table 5.g

Key:

EY=	normal temperature
1	no defrost
2	defrost by time
3	heating output (reverse)
4	defrost with temp. control (d0= 4)

easy split parameter sets (EZY)

Par.	Description	models S-X (normal temperature)				models Y-C (low temperature)			
		EZY=1	EZY=2	EZY=3	EZY=4	EZY=1	EZY=2	EZY=3	EZY=4
/4	select probe displayed	1	1	1	1	-	-	-	-
/5	select °C/°F	0	0	0	0	-	-	-	-
rd	control differential	3.0	3.0	5.0	2.0	3.0	4.0	5.0	2.0
r1	minimum set point value	-10.0	-15.0	-20.0	-30.0	-30.0	-30.0	-30.0	-30.0
r2	maximum set point value	15.0	20.0	20.0	40.0	20.0	20.0	30.0	40.0
r3	select direct/reverse operation	1	0	2	0				
r4	night-time set point delta	-	-	-	-	5.0	5.0	2.0	4.0
c1	minimum time between consecutive compressor starts	3	5	0	6	4	5	3	6
c2	minimum compressor off time	2	4	0	4	2	3	0	5
d0	type of defrost	2	2	0	4	1	2	3	4
dl	interval between defrosts	6	10	6	12	5	7	10	12
dt	end defrost temperature set point/defrost temperature threshold with temp. control	5.0	5.0	5.0	5.0	5.0	5.0	5.0	4.0
dP	maximum defrost duration	40	40	40	40	20	40	10	50
d6	freeze control temperature display during defrost	1	1	1	1	-	-	-	-
dC	time base	0	0	0	0	0	0	0	0
A0	alarm and fan temperature differential	2.0	2.0	2.0	2.0	2.0	2.0	2.0	2.0
AL	temperature alarm threshold/deviation	20.0	25.0	20.0	20.0	22.0	15.0	18.0	20.0
AH	high temperature alarm threshold/deviation	20.0	25.0	20.0	20.0	22.0	25.0	20.0	25.0
Ad	temperature alarm delay	60	70	60	60	20	40	30	25
A4	3rd input configuration	-	-	-	-	0	4	1	0
A7	digital input alarm delay	-	-	-	-	0	20	30	20
Ac	set point dirty condenser alarm	55.0	50.0	70.0	55.0	55.0	55.0	55.0	55.0
AE	dirty condenser alarm differential temperature	10.0	8.0	10.0	10.0	10.0	10.0	10.0	10.0
Acd	dirty condenser alarm delay	60	40	200	60	60	60	60	60
F0	enable evaporator fan control	-	-	-	-	1	0	1	0
F1	evaporator fan control set point	-	-	-	-	5.0	5.0	5.0	5.0
F2	stop evaporator fan if compressor off	-	-	-	-	1	1	1	1
F3	evaporator fan status during defrost	-	-	-	-	1	1	1	1
Fd	post-dripping time	-	-	-	-	3	4	5	6

Table 5.h

Key:

EZY=	normal temperature	low temperature
1	no defrost	defrost by hot gas
2	defrost by time	automatic night-time set point variation from digital input
3	heating output (reverse)	digital input alarm management
4	defrost with temp. control (d0= 4)	defrost by temperature (d0=4)

5.10 Troubleshooting

The following table shows a number of anomalous situations that may occur on the various models.

The most frequent causes and corresponding checks are described:

problem	cause	checks
the compressor does not start (signalled by the compressor LED flashing)	<ul style="list-style-type: none"> compressor delay set defrost post dripping in progress 	parameters c0, c1 and c2 and dd
the temperature is over the set limits but there is no alarm message and the buzzer, if fitted, does not sound	alarm delay set	parameters Ad, c6, d8
alarm IA is signalled (multifunction input) without actually being active	the multifunction input generates an alarm when the contact opens	connection of the input and whether this is closed in normal operation
the alarm connected to the multifunction input is not detected	alarm delay set or parameter programming error	<ol style="list-style-type: none"> if A4=1 the status of digital input A7
the defrost is not activated	<ul style="list-style-type: none"> defrost duration too short (dP) interval between defrosts dl=0: in this case the defrost is not activated 	parameters dP and dl and H1 for S models
	the end defrost temperature is too low or the evaporator temperature is too high	parameters dt and d/ (defrost probe)
the manual defrost is not activated and the defrost LED flashes	compressor protection times set	parameter d9 (select d9=1)
the high temperature alarm is shown after a defrost	the alarm delay after defrost is too short or the alarm threshold is too low	parameters d8 and AH
the display remains frozen even after the defrost	the ambient temperature has not yet reached the set point or alternatively the time d8 has not elapsed	wait or reduce d8
after modifying a parameter the controller continues working with the old values	the instrument has not updated the old value or alternatively the parameter setting procedure has not been ended correctly by pressing the SET button for 3 s	turn the instrument off and on again or alternatively reprogram the parameters correctly
for C models, the fan does not start	<ol style="list-style-type: none"> a compressor and fan start delay has been set if F0=1 (fan managed by fan controller) <ul style="list-style-type: none"> the evaporator is "hot": the evaporator temperature can be read by selecting parameter /d; dripping in progress; F1 (evaporator fan control set point) too low. post-dripping delay set if F0=0 <ul style="list-style-type: none"> F2=1 and the compressor is off dripping in progress post-dripping in progress 	<ol style="list-style-type: none"> parameter c0 parameters F0, F1, Fd, dd and d/ parameters F0, F2, dd and Fd

Table 5.i

6. TECHNICAL SPECIFICATIONS

6.1 easy technical specifications

power supply (*)	230 Vac +10 /-15% 50/60 Hz; 115 Vac +10 /-15% 50/60 Hz 12 Vac 10/-15 %, 50/60 Hz class 2 12 Vdc (11...16 Vdc) class 2
rated power	1.5 VA
inputs (*)	NTC or PTC probes, 1 or 3 inputs. Digital input as alternative to third probe
relay outputs (*)	2 HP relay UL: 12 A Res. 12 FLA 72 LRA, 240 Vac (***) UL: 12 A Res. 10 FLA 60 LRA, 240 Vac (***) EN60730-1: 10(10) A 250 Vac(**) 16 A relay UL: 12 A Res. 5FLA, 30LRA 250 Vac, C300 EN60730-1: 12(2) A NO/NC, 10(4) A fino 60 °C NO, 2(2) A CO, 250 Vac 8 A relay UL: 8 A Res. 2 FLA 12 LRA, 250 Vac C300 EN60730-1: 8(4) A NO, 6(4) A NC, 2(2) A CO, 250 Vac
probe type (*)	Std CAREL NTC 10 KΩ at 25 °C Std CAREL PTC 985 Ω at 25 °C
connections (*)	screw terminals for cables with cross-sect. from 0.5 mm ² to 1.5 mm ² . Plug-in terminals for screw blocks or with crimped contacts (cable cross-sect. up to 2.5 mm ²). Maximum rated current per terminal 12 A.
assembly (*)	terminal: using screws from the front or with rear brackets
display	3 digit LED display with sign, -199 to 999 and decimal point; six status LEDs
operating conditions	-10T50 °C - humidity <90% RH non-condensing
storage conditions	-20T70 °C - humidity <90% RH non-condensing
detection range	-50T90 °C (-58T194 °F) - resolution 0.1 °C/°F
front panel index of protection case	panel installation with IP65 gasket plastic terminal, 81x36x65 mm
classification according to protection against electric shock environmental pollution	Class 2 when suitably integrated normal
PTI of the insulating materials	250 V
period of stress across the insulating parts	long
category of resistance to heat and fire	category D (UL94 - V0)
immunity against voltage surges	category 1
type of action and disconnection	1 C relay contacts
no. of relay automatic operating cycles (*)	EN60730-1: 100,000 operations UL: 30,000 operations (250 Vac)
software class and structure	Class A
cleaning the instrument	only use neutral detergents and water
max. cable length	1 km serial; 30 m probes; 10 m relay

Table 6.a

(*) The features shown depend on the model.

(**) Minimum T OFF between two starts must be greater than 1 min.

(***) only for models PJEZ (M, S, X) *

(****) only for models PJEZ (C, Y) *

Warning: do not run the power cable less than 3 cm from the bottom of the device or the probes; for the connections, only use copper wires.

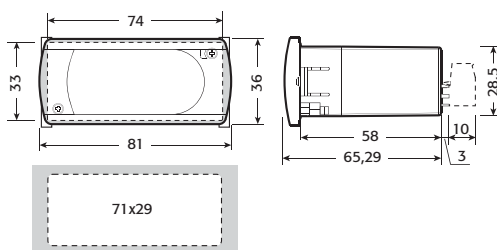

Fig. 6.a

6.2 easy compact technical specifications

power supply (*)	230 Vac, -10+15 % 50/60 Hz; 115 Vac, -10+15 % 50/60 Hz; 12 Vdc ±10% or 12 Vac, ±10% 50/60 Hz (PJEZM* only, without AUX relay);
rated power	0.5 VA
inputs (*)	NTC or PTC probes, 1 or 2 inputs
relay output (*)	2HP relay: UL: 12A 10 FLA 60 LRA 250 Vac 30000 cycles; EN60730-1: 10(10)A 250Vac 100000 cycles (**); 16A relay UL: 12A resistive 5FLA, 30LRA 250Vac 30000 cyc. EN60730-1: 12(2)A or 10(4)A (N.O. only) 250VAC 100000 cycles;
Type of probe (*)	Std CAREL NTC 10 KΩ at 25 °C Std CAREL PTC 985 Ω at 25 °C
Power supply/relay output connector (*)	screw terminals, 5 mm pitch for cables with cross-sect. from 0.5 mm ² to 1.5 mm ² ; 12A max; plug-in terminals, 5.08 mm pitch for screw blocks or with crimped contacts for cables with cross-sect. from 0.5 mm ² up to 2.5 mm ² ; 12A max;
Probe connector (*)	screw terminals: - 2 pin, 5 mm pitch for models with 1 probe (cable cross-section from 0.5 mm ² to 1.5 mm ²); 12A max; - 3 pin, 3.81 mm pitch for models with 2 probes (cable cross-section from 0.08 mm ² to 1.5 mm ²); 6A max; plug-in terminals for screw blocks or with crimped contact: 2 pin, 5.08 mm pitch for models with 1 probe (cable cross-section from 0.5 mm ² to 1.5 mm ²); 12A max; - 3 pin, 3.81 mm pitch for models with 2 probes (cable cross-section from 0.08 mm ² to 1.5 mm ²); 8 A max;
Serial connector	1 connector for the network of supervisor connection or for the parameter programming key (only on the models where featured);
Assembly	using screws from the front or with rear brackets
Display	LED display, 2 digits plus sign, decimal point and compressor icon
Keypad	3 membrane buttons

Table 6.b

(*) The features shown depend on the model.

(**) Minimum T OFF between two starts must be greater than 1 min.

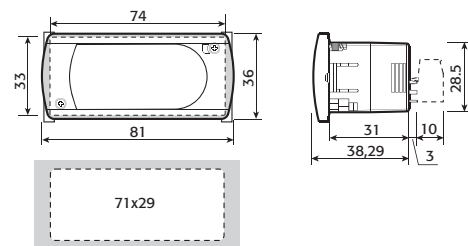

Fig. 6.b

6.3 easy split technical specifications

power supply (*)	230 Vac +10/-15%, 50/60 Hz; 115 Vac +10/-15%, 50/60 Hz	
power input (controller only)	7 VA: 30 mA~ at 230 Vac; 7 VA: 60 mA~ at 115Vac	
inputs	2 probe inputs, NTC (-50T90°C) or HT NTC(-40T150°C); 1 digital input as alternative to third probe	
relay outputs (***)	RL1:	EN60730-1: 12(10)A 250Vac 100000 cycles, UL: 16A Res. 16FLA 96LRA 250Vac (**) 30000 cycles
	RL4:	EN60730-1: 12(10)A 250Vac 100000 cycles, UL: 12A Res. 12FLA 72LRA 250Vac (**) 30000 cycles
	RL3, RL2:	EN60730-1: 12(2)A 250Vac 100000 cycles (N.O. contact only), UL: 12A Res. 2FLA 12LRA 250Vac (**) 30000 cycles
type of probe	Std CAREL NTC 10kΩ ±1% at 25°C Std CAREL NTC-HT 50kΩ ±1% at 25°C	
connections	- input/output signals: screw terminals with cables from 0.5 to 1.5 mm ² ; - faston terminals: recommended cable cross-section 2.5 mm ² for current ratings up to 16 A; - use: - cables with max. operating temperature at least 90 °C; - fully insulated faston terminals with max. operating temperature at least 100 °C; - power supply: cable cross-section 2.5 mm ² for current ratings up to 16 A and 4 mm ² for current ratings up to 24 A; - earth connections: see the instructions about power supply connections.	
assembly	PJEZ*8**4* (without plastic case): maximum supply current 24 A PJEZ*8**5* (with plastic case): maximum supply current 16 A - terminal: using screws from front panel or with rear brackets - power board: on models PJEZ*8**5* supplied with plastic case	
display	3 digit LED display with sign -199 to 199 and decimal point, 6 status LEDs	
operating conditions	PJEZ*8**4* (without plastic case):- - 10T60°C for power board; - 10T60°C for display; humidity <90% RH non-condensing.	PJEZ*8**5* (with plastic case): - 10T50°C for power board; - 10T60°C for display; humidity <90% RH non-condensing.
storage conditions	-20T70°C, humidity <90% RH non-condensing	
range of measurement	- NTC probe: -50T90°C(-58T194°F), resolution 0.1 °C/°F - NTC-HT probe: -40T150°C(-40T302°F), resolution 0.1 °C/°F	
index of protection	- display (front): IP65 - box-mounted power board: IP00	
dimensions	plastic terminal: 81x36x38.29 mm power board: plastic box 190x140x70 mm	
classification according to protection against electric shock	class 1	
environmental pollution	grade 3	
PTI of insulating materials	250 V	
period of stress across the insulating parts	long	
category of resistance to heat and fire	category D (UL94 – V0)	
immunity against voltage surges	category 3	
type of action and disconnection	1C relay contacts	
construction of the control device	integrated electronic control device	
no. of relay automatic operating cycles	EN60730-1: 100000 operations;UL873: 30000 operations.	
software class and structure	class A	
cleaning	only use neutral detergents and water	
max cable length	serial: 1 km; probes/digital inputs: 10 m; relay: 10 m	
conformity	EN60730-1, EN61000-6-1, EN61000-6-2, EN61000-6-3, EN61000-6-4, EN61000-4-2, EN61000-4-3, EN61000-4-4, EN61000-4-5, EN61000-4-6, EN61000-4-11	

Table 6.c

*) The features shown depend on the model.

(**) Minimum T OFF between two starts must be greater than 1 min.

(***) Conformity to UL873 only corresponds to models without plastic case.

Terminal

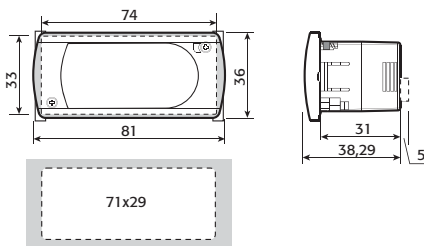

Fig. 6.c

Power board

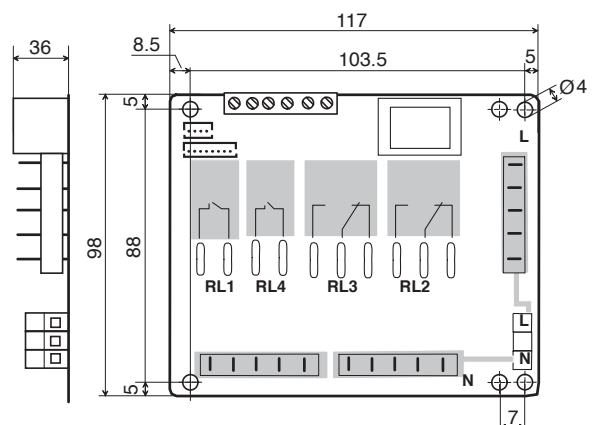

Fig. 6.d

6.4 Electromagnetic compatibility

The easy and easy compact series is compliant with the EU standards on electromagnetic compatibility:

- for household appliances EN 55014-2 and EN 55014-1;
- for residential, commercial and light industrial environments EN 50082-1 and EN 50081-1;
- for industrial environments EN 50082-2 and EN 50082-1;
- as regards safety, the devices are compliant with standards EN60730-1 and EN60730-2-9.

CAREL

CAREL INDUSTRIES - HQs

Via dell'Industria, 11 - 35020 Brugine - Padova (Italy)
Tel. (+39) 049.9716611 - Fax (+39) 049.9716600
e-mail: carel@carel.com - www.carel.com

Agenzia / Agency: