

# 12 Die High Power Mixing LED

IxR-XM01-00xA-SC201-CON25.

The IxR-XM01-00xA-SC201-CON25. has at its heart, a 12 die T9090 multi-chip package from Taiwan Semiconductor Limited. Each of the 12 die are independently connected, allowing for full flexibility and control. The MCPCB based product, also has a standard 25way Molex connector for simple interconnect to your control equipment.

Mounting of the IxR-XM01-00xA-SC201-CON25. couldn't be simpler, as it fits on the industry standard Zhaga footprint, and is designed to work with LEDiL Hekla connectors and mating reflectors.

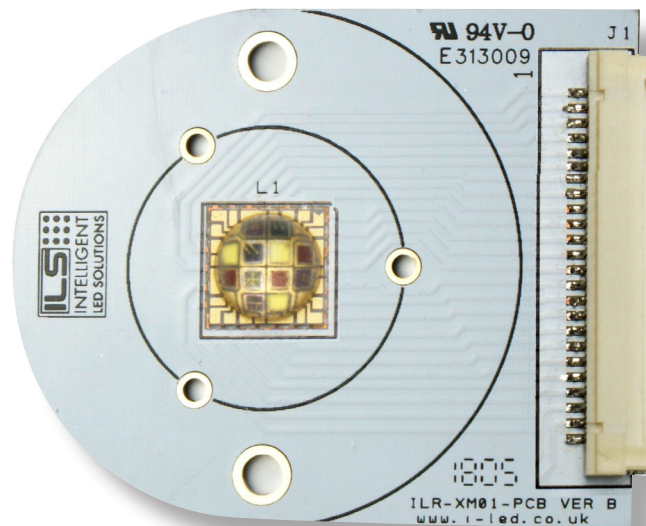

## CONTENTS

Applications	<a href="#">page 2</a>	Typical Forward Voltage	<a href="#">page 11</a>
Technical Features	<a href="#">page 2</a>	Lens and Reflector Options	<a href="#">page 12-13</a>
Technical Drawings	<a href="#">page 4</a>	Heatsink Options	<a href="#">page 14</a>
LED Radiation Diagram	<a href="#">page 5</a>	Power Supply Options	<a href="#">page 15</a>
Pin Out of LED	<a href="#">page 5-8</a>	Thermal Interface Material Options	<a href="#">page 15</a>
LED Characteristics	<a href="#">page 9</a>	Important Information and Precautions	<a href="#">page 16</a>
Typical Forward Luminance	<a href="#">page 10</a>	Safety Information	<a href="#">page 17</a>

## APPLICATIONS INCLUDE

- » General Lighting
- » Decorative Lighting
- » Task Lighting
- » Horticultural Lighting
- » Architectural Lighting
- » Retail and Entertainment Lighting
- » Speciality Lighting
- » Medical and Analytical Lighting
- » Infrared Illumination
- » Full Spectrum Illumination

## TECHNICAL FEATURES

LED/s	TSLC T9090U Multi Die LED
Lifetime	
Mounting	Mounting holes using industry standard Zhaga format
Dimensions (L x W x H)	55mm x 45mm x 5mm
Wiring	Cable required
Lenses and Reflectors	Integral 140 degree silicone lens. Secondary Lens can be fitted. Suitable options on <a href="#">page 12</a> or visit <a href="#">our website</a> for a full range.
Heatsinks	Required. Suitable options on <a href="#">page 14</a> or visit <a href="#">our website</a> for a full range
Power Supply	Suitable options on <a href="#">page 15</a> or visit <a href="#">our website</a> for a full range.
DC Forward Current (mA)	Red/Amber/NIR: 700mA UV/Blue/Green/Cyan/White: 1000mA
LED Junction Temperature	Red/Amber/NIR: 115°C UV/Blue/Green/Cyan/White: 150°C
LED Operating Temperature	-40°C...85°C
Storage Temperature	-40°C...110°C
Soldering Temperature at Tp(JEDEC-020)	20 to 40 Seconds
ESD Sensitivity	2,000V HBM (JESD-22A-114-B)
Reverse Voltage	Not designed to be driven in reverse bias
Preconditioning	Acc. To JEDEC Level 1

## ACCESSORIES

### Lenses and Reflectors



LEDiL precision-engineered Lenses and Reflectors allow for rapid deployment of all types of light fixtures, including street lights, wall-wash, high-bay, sconces, emergency beacons, parking garage/low-bay, MR and AR downlights, and dock lights. Precision-engineered for maximum efficiency and durability, LEDiL Lenses and Reflectors are released alongside the latest product releases from our LED suppliers. Suitable options on [page 12](#) or visit [our website](#) for a full range.

### Heatsinks

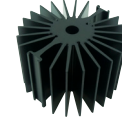

ILS has a series of Aluminium Alloy Heatsinks to be used with our standard range of PowerStars and PowerClusters. These Heatsinks are supplied with fixing screws for the light engine and for fixing to a base plate. They also come with Thermal Interface Material (TIM) attached to the top surface. Suitable options on [page 14](#) or visit [our website](#) for a full range.

### Power Supplies

ILS has a comprehensive range of standard Power Supplies. The table below shows the total number of ILS products each Power Supply can drive. Additional Power Supplies are being introduced so please call us or [check our website](#) for the latest offering. Suitable options on [page 15](#)

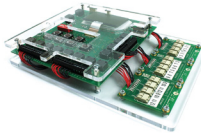

### Thermal Interface Material (TIM)

ILS have produced a range of High-performance, cost effective Thermal Interface Materials to match perfectly their standard products. Our product fills the air pockets between the two surfaces, forming a continuous layer to conduct heat away from the LED to the Heatsink. ILS offer our TIM in three options - double sided adhesive, single sided adhesive and non adhesive. Suitable options on [page 15](#) or visit [our website](#) for a full range.

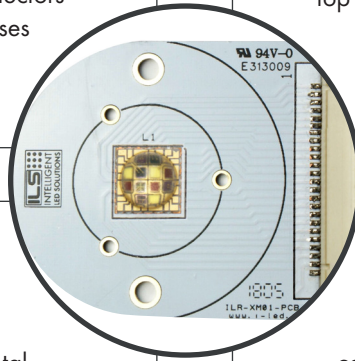

# TECHNICAL DRAWINGS (MM)

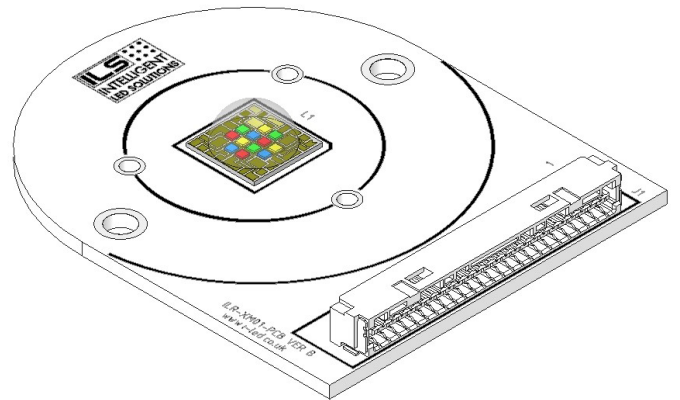
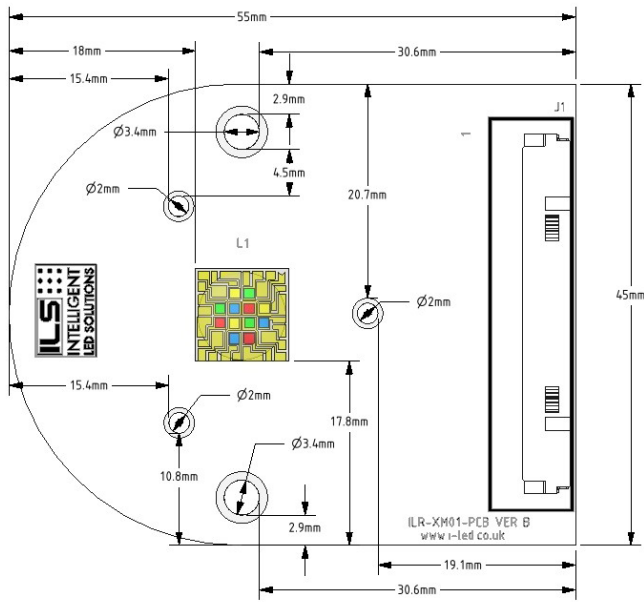
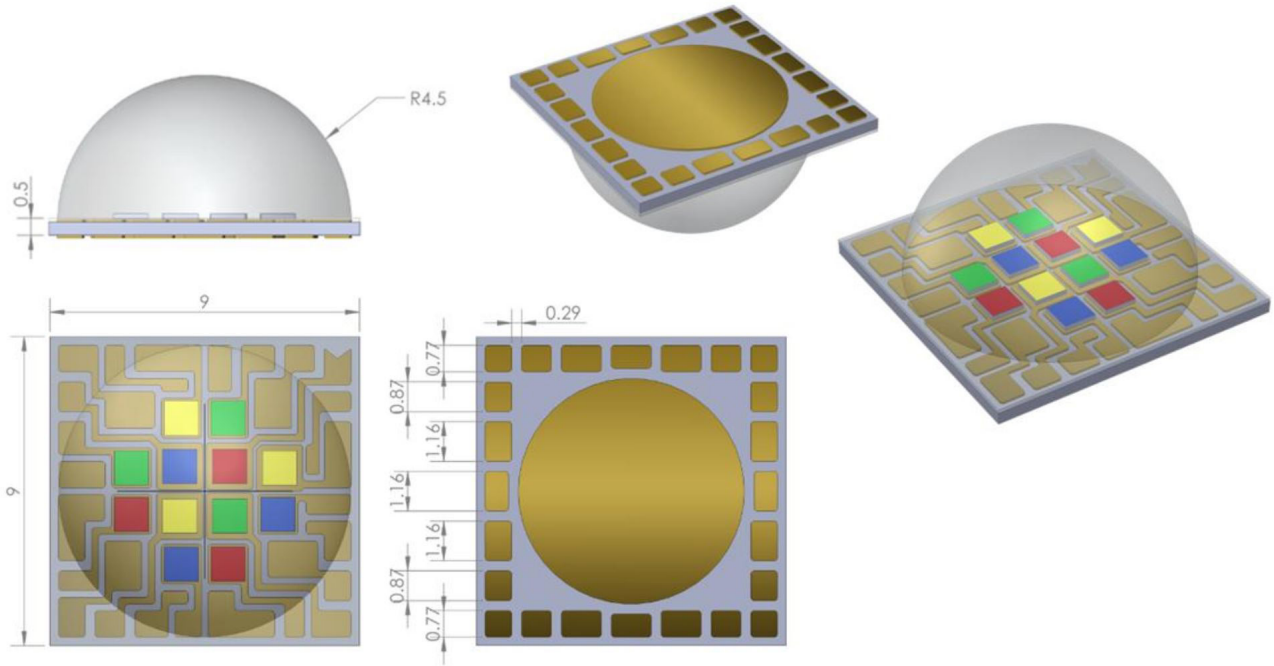

3D drawing files are available on request from ILS. Please call or email

## RADIATION OF SINGLE LED

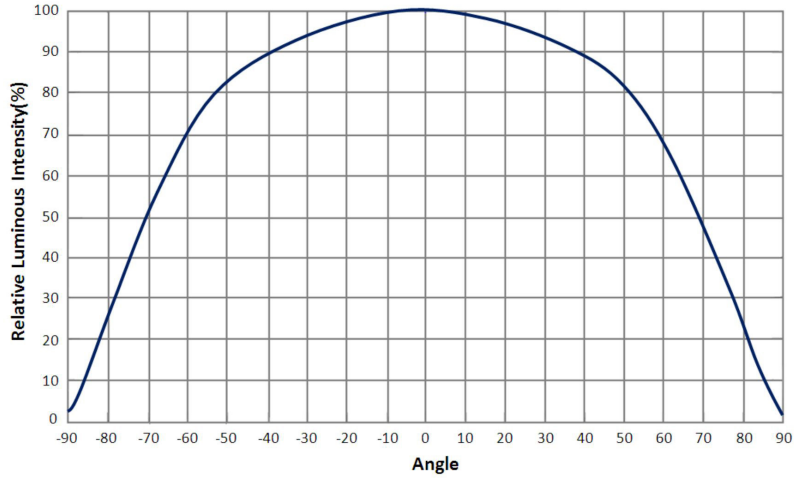

## PIN OUT OF LED

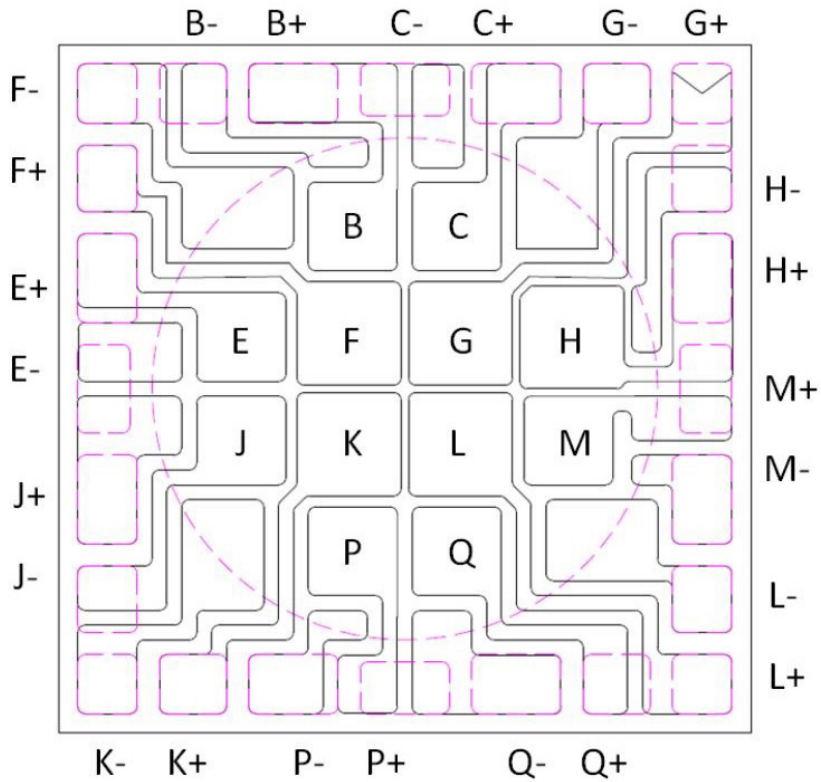

## PIN OUT OF IXR-XM01-00XA-SC201-CON25.

Connector Pin Number	Description
1	E CATHODE
2	E ANODE
3	F CATHODE
4	F ANODE
5	B CATHODE
6	B ANODE
7	C CATHODE
8	C ANODE
9	G CATHODE
10	G ANODE
11	H CATHODE
12	H ANODE
13	M ANODE

Connector Pin Number	Description
14	M CATHODE
15	L CATHODE
16	L ANODE
17	Q ANODE
18	Q CATHODE
19	P ANODE
20	P CATHODE
21	K ANODE
22	K CATHODE
23	J CATHODE
24	J ANODE
25	NO CONNECT

Different connector manufacturers use different pin 1 locations, therefore please use the reference marked on the PCB

## ILR-XM01-001A-SC201-CON25.

## 12 DIE LED ARRAY VERSION 001A - FULL SPECTRUM

The ILR-XM01 Full spectrum version allows users to control 12 individual die ranging from 360nm to 955nm. These full spectrum light engines offer unparalleled ability to investigate the cause and effect of various wavelengths for your spectral analysis.

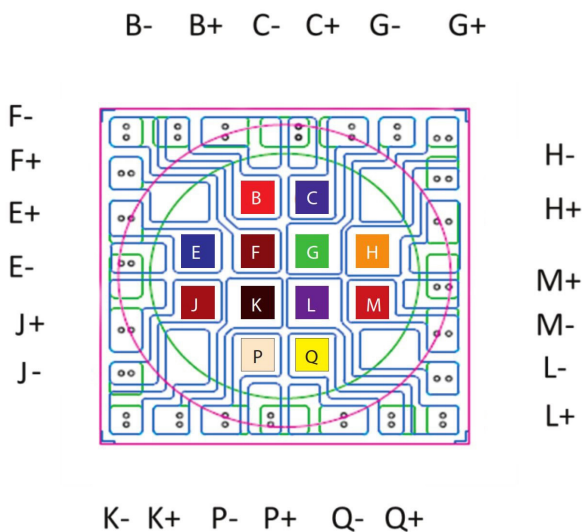

● B	Red	620-630
● C	UV	380-390
● E	Deep Blue	445-465
● F	IR	840-870
● G	Green	490-535
● H	Amber	580-600
● J	Far Red	720-740
● K	IR	925-955
● L	UV	360-370
● M	Hyper Red	650-670
● P	Warm White	<3750
● Q	Cool White	>4750

## IHR-XM01-002A-SC201-CON25.

## 12 DIE LED ARRAY VERSION 002A - HORTICULTURAL

The IHR-XM01 Horticultural version enables users to investigate how different wavelengths and radiant intensities affect the specific needs of different plants. These light engines allow the creation of customised spectral outputs to match your target requirement.

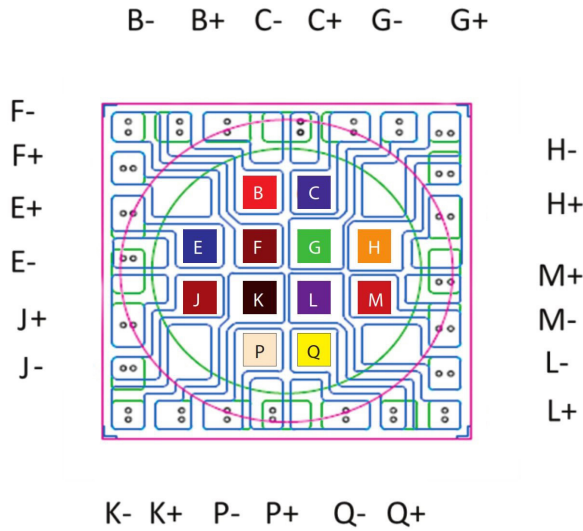

● B	Cool White	>4750
● C	UV	380-390
● E	Deep Blue	445-465
● F	Hyper Red	650-670
● G	Far Red	720-740
● H	True Green	525-530
● J	Far Red	720-740
● K	True Green	525-530
● L	UV	380-390
● M	Hyper Red	650-670
● P	Warm White	<3750
● Q	Deep Blue	445-465

## ILR-XM01-003A-SC201-CON25.

## 12 DIE LED ARRAY VERSION 003A - TUNEABLE WHITE

Simple Tuneable white products just offer whites of differing CCTs to create the colour changing profiles.

This process works, but the resultant output does not follow the black body across all available outputs, and also the CRI can suffer across the output spectra. The ILR-XM01 Tuneable White product not only gives the user various white CCT die, but also red, green and amber which when mixed in solves the problems of low CRI and enables the output to closely match the black body.

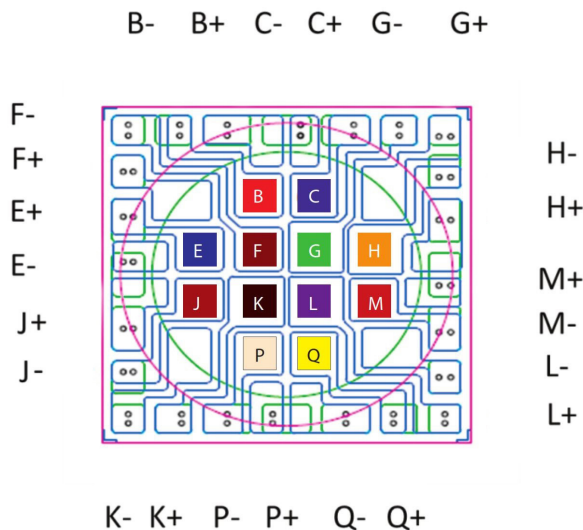

● B	Neutral White	3750-4750
● C	Warm White	<3750
● E	Cool White	>4750
● F	Red	620-630
● G	Neutral White	3750-4750
● H	PC Amber	610nm
● J	Cool White	>4750
● K	Neutral White	3750-4750
● L	Warm White	<3750
● M	Green	525-530
● P	Warm White	<3750
● Q	Cool White	>4750

## ILR-XM01-004A-SC201-CON25.

## 12 DIE LED ARRAY VERSION 004A - WHITE &amp; IR

Many camera systems nowadays are required to not just work in one range of the spectrum i.e. IR and White light. The ILR-XM01 White & IR product enables users to investigate the use of multiple different IR wavelengths alongside white light in their application. Offering the ability to test 730nm, 850nm and 940nm alongside white, the ILR-XM01 White & IR product is a versatile camera vision testing system.

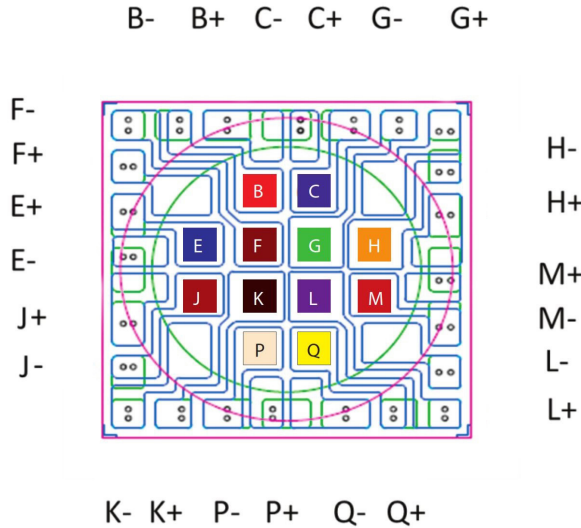

● B	IR	925-955
● C	IR	840-870
● E	Cool White	>4750
● F	IR	840-870
● G	Cool White	>4750
● H	Far Red	720-740
● J	Far Red	720-740
● K	IR	925-955
● L	Far Red	720-740
● M	IR	925-955
● P	IR	840-870
● Q	Cool White	>4750

## ILR-XM01-005A-SC201-CON25.

## 12 DIE LED ARRAY VERSION 005A - RGBW

The ILR-XM01 RGBW product offers control of 12 individual die, 3 of each colour, for full high intensity tuneable performance.

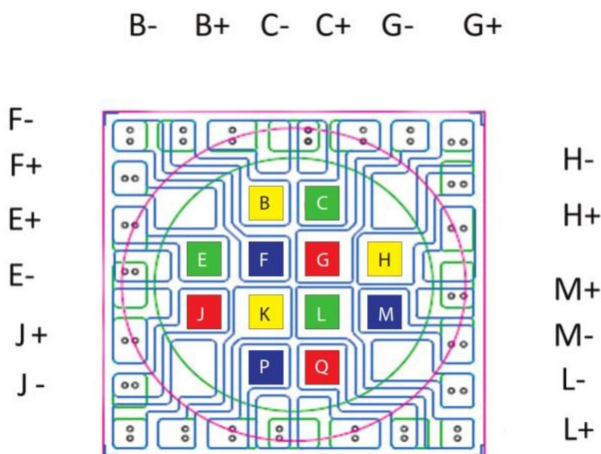

● B	White	500-8000K
● C	Green	515-530
● E	Green	515-530
● F	Blue	450-460
● G	Red	620-635
● H	White	5000-8000K
● J	Red	620-635
● K	White	5000-8000K
● L	Green	515-530
● M	Blue	450-460
● P	Blue	450-460
● Q	Red	620-635



## LED CHARACTERISTICS

Ordering Code	CCT/Dominant/*Peak Wavelength Range	Minimum Luminous Flux @350mA	Forward Voltage (V)	
			Min	Max
UV-1	360nm*	370nm*	2.8	3.6
UV-2	370nm*	380nm*		
UV-3	380nm*	390nm*		
UV-4	390nm*	400nm*		
NUV-1	400nm*	410nm*		
NUV-2	410nm*	420nm*		
Blue-1	440nm	450nm		
Blue-2	450nm	460nm		
Blue-3	460nm	470nm		
Cyan	490nm	510nm		
Green	520nm	535nm	2.0	3.0
Amber	585nm	595nm		
Orange	600nm	620nm		
Red	620nm	630nm		
Hyper Red	650nm*	670nm*		
Far Red	720nm*	740nm*		
NIR-2	840nm*	870nm*		
NIR-3	925nm*	955nm*	1.2	2.0
Ultra-White	7000K	10000K	2.8	3.6
Cool White	5500K	7000K		
Neutral White	3750K	5500K		
Warm White	2400K	3750K		
PC Amber	580nm	585nm		
PC Green	550nm	570nm		

## Notes:

1. T9090M-MCL1 product is tested and binned at 350mA.
2. Dominant wavelength is measured with an accuracy of  $\pm 1$  nm.
3. Forward voltage is measured with an accuracy of  $\pm 0.2$  V.
4. Flux is measured with an accuracy of  $\pm 10$ %.

# TYPICAL FORWARD LUMINANCE VS CURRENT CHARACTERISTICS

UV/Blue/ Green/ Cyan/ White Series

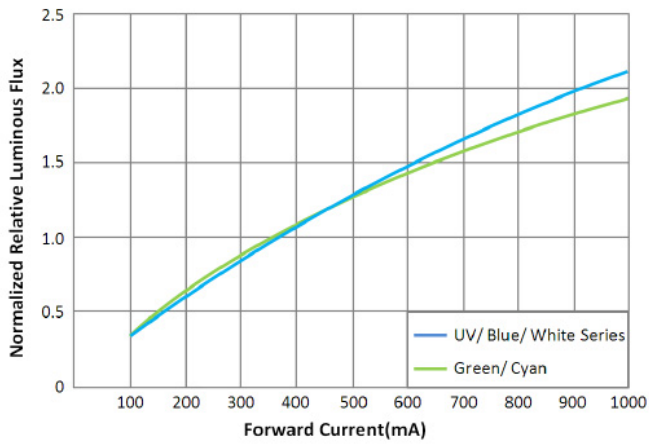

Amber / Red / Super Red

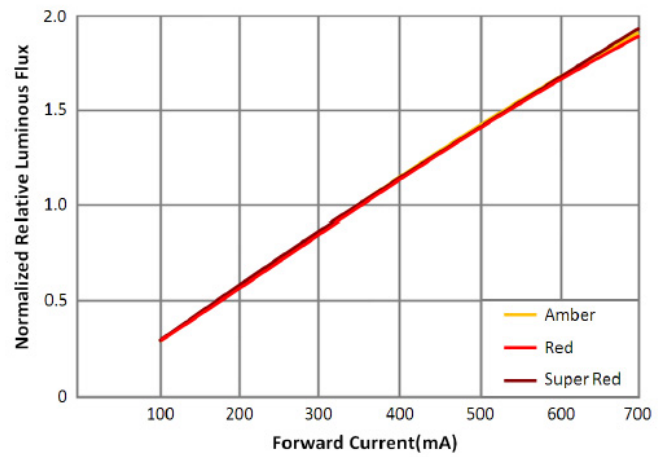

IR series

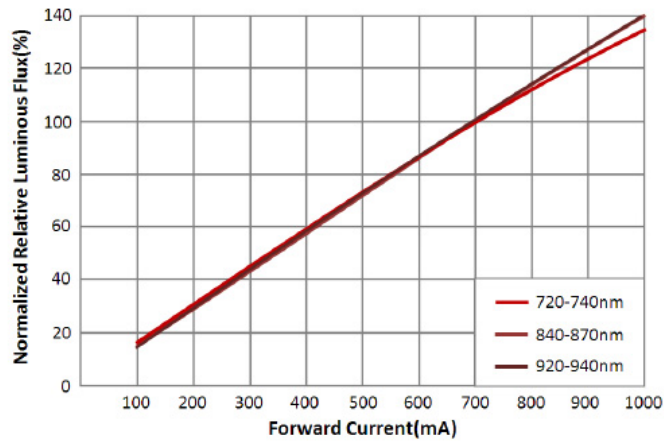

# TYPICAL FORWARD VOLTAGE VS CURRENT CHARACTERISTICS

Blue/ Green/ Cyan/ White Series

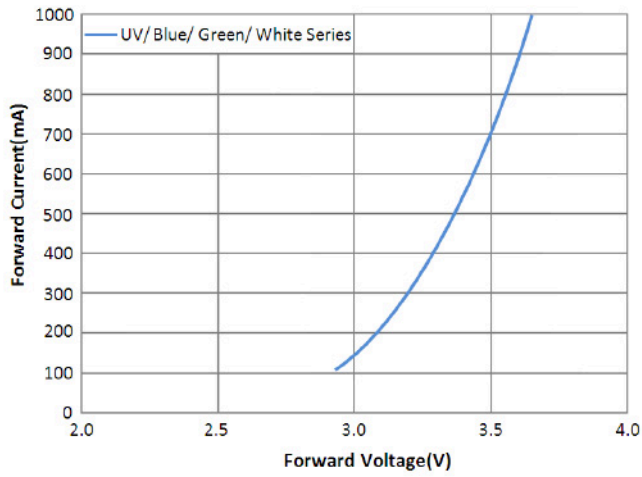

Amber / Red / Super Red

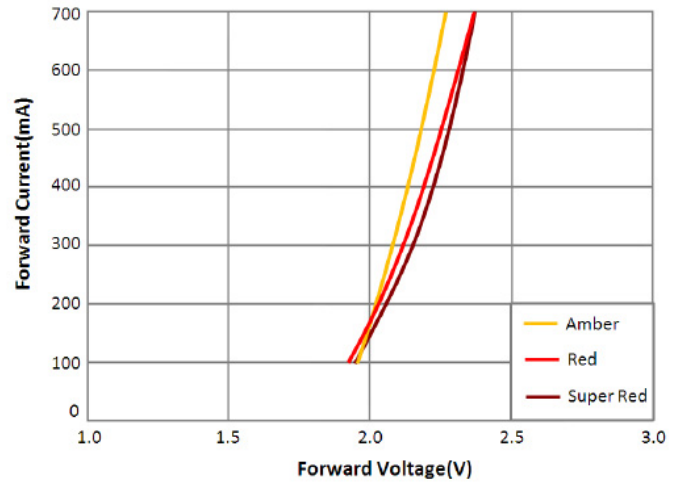

IR Series

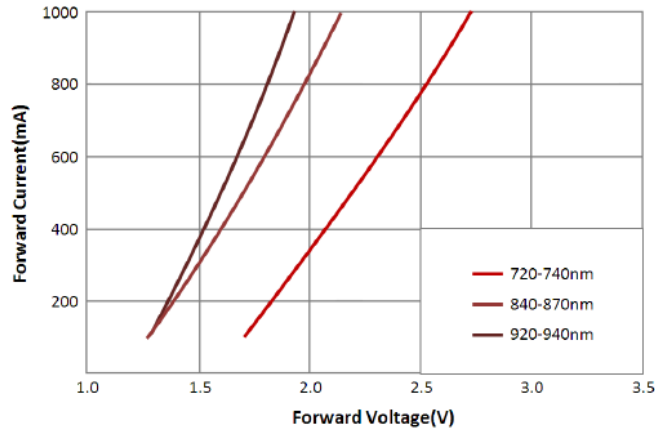

## LENS AND REFLECTOR OPTIONS

LEDiL precision-engineered Lenses and Reflectors allow for rapid deployment of all types of light fixtures, including street lights, wall-wash, high-bay, sconces, emergency beacons, parking garage/low-bay, MR and AR down lights, and dock lights. Precision-engineered for maximum efficiency and durability, LEDiL Lenses and Reflectors are released alongside the latest product releases from our LED suppliers. You select the best LED for the application; choose LEDiL and you're selecting the best optical solution as well.

Ordering Code	Beam	Diameter	Height	Family	FWHM	Colour	Fastening
FP15501_HEKLA-C	44	5.5	Hekla	Clear			
F15255_HEKLA-SOCKET-C	44	5.5	Hekla	White	Screw		
C15419_ZORYA-MINI	Decorative	24	14.2	Zorya	145°	Clear	Glue, Tape, Clips, Snaps
CA15584_ZORYA-MINI-TAPE	Decorative	24	14.6	Zorya	145°	Clear	Tape, Snaps
CN15822_WINNIE-S-C	S	50	19.5	Winnie	15°	Black	
CN15824_WINNIE-M-C	M	50	19.5	Winnie	26°	Black	
CN15825_WINNIE-W-C	W	50	19.5	Winnie	53°	Black	
CN15826_WINNIE-O-C	O	50	19.5	Winnie	64+18°	Black	
CN16191_WINNIE-WW-C	WW	49.8	Winnie	69°	Clear	Socket	
CP15774_CARMEN-S-C	S	69.5	41.5	Carmen	14°	Black	Socket
CP15775_CARMEN-M-C	M	69.5	41.5	Carmen	Black	Socket	
CP15776_CARMEN-W-C	W	69.5	41.5	Carmen	50.7°	Black	Socket
CP15916_CARMEN-RS-C	RS	69.5	41.5	Carmen	12°	Black	Socket
CP16106_CARMEN-50-RS-C	RS	50	25.45	Carmen	10°	Socket	
CP16107_CARMEN-50-S-C	S	50	25.45	Carmen	21°	Socket	
CP16108_CARMEN-50-M-C	M	50	25.45	Carmen	29°	Socket	
CP16109_CARMEN-50-W-C	W	50	25.45	Carmen	46°	Socket	
CX15577_GABRIELLA-45-S	S	45	30.4	Gabriella	11°	Clear	Tape, Pin, Screw
CX15818_GABRIELLA-45-M	M	45	29.24	Gabriella	23°	Black	Tape
CX15819_GABRIELLA-45-W	W	45	30.34	Gabriella	32°	Clear	Tape, Pin, Screw
F14738_BROOKE-G2-S	S	45	19.7	Brooke	18°	Metal	Socket
F14739_BROOKE-G2-M	M	45	19.7	Brooke	25°	Metal	Socket
F15558_MIRELLA-G2-S	S	49.9	24.8	Mirella	19°	Metal	
F15559_MIRELLA-G2-M	M	49.9	24.8	Mirella	27°	Metal	
F15560_MIRELLA-G2-W	W	49.9	24.8	Mirella	38°	Metal	Socket
F15558_MIRELLA-G2-S	S	49.9	24.8	Mirella	19°	Metal	
F16002_MIRELLA-G2-WW	WW	49.9	23.57	Mirella	55°	Metal	Socket
F16363_BARBARA-G2-S	S			Barbara			
F16364_BARBARA-G2-M	M			Barbara			
F16365_BARBARA-G2-W	W			Barbara			
F16366_BARBARA-G2-WW	WW			Barbara			
FN15966_RONDA-WWW-C	WWW	53.9	16.6	Ronda	89°	Clear	Socket
FN15968_RONDA-WW-C	WW	53.9	16.6	Ronda	53°	Clear	Socket
FN15969_RONDA-W-C	W	53.9	16.6	Ronda	27°	Clear	Socket
FN15970_RONDA-S-C	S	69.9	14.6	Ronda	18°	Clear	Socket
FN15971_RONDA-WAS-C	Asymmetric	53.9	23.65	Ronda	Asymmetric	Clear	Socket
FN15972_RONDA-ZT45-C	Asymmetric	69.9	14.6	Ronda	Asymmetric	Clear	Socket
FN15973_RONDA-REC-60-C		69.9	14.6	Ronda	58°		
FN15974_RONDA-REC-90-C		69.9	14.6	Ronda	85°		
FN15975_RONDA-WAS2-C	Asymmetric	53.9	23.65	Ronda	Asymmetric	Clear	Socket

Ordering Code	Beam	Diameter	Height	Family	FWHM	Colour	Fastening
FN15998_RONDA-O-C	Asymmetric	53.9	16.6	Ronda	50+17°	White	Socket
FP15072_ZORYA-SC-HEKLA	Decorative	55	35	Zorya		White	Socket
FP15073_ZORYA-SC-50	Decorative	56	29.1	Zorya	256°	Clear	Socket







[Click here to visit our website for our latest range](#)

## HEATSINK OPTIONS

ILS Product		IxR-XM01-00xA-SC201-CON25.
No Heatsink, in free air		
ILA-HSINK-RADL-120X40MM-BLK		
ILA-HSINK-RADL-70X70MM-BLK		
ILA-HSINK-RADL-100X65MM-BLK		
ILA-HSINK-RADL-100X80MM-BLK		
ILA-HSINK-RADL-120X150MM-BLK		

**KEY**

-  Operates under the recommended ILS junction temperature
-  Operates under the recommended LED maximum junction temperature
-  Not suitable for use
-  Heatsink not designed for use with this product

[Click here to visit our website for our latest range](#)

## POWER SUPPLY OPTIONS

ILS have developed their own power supply to enable easy development of the IxR-XM01-00xA-SC201-CON25.

### ILA-12CHANNEL-LED-TUNER-001.

ILS have developed a driver to help in the development of Tuneable White and RGBW multi-LED products, or any system that requires up to 12 channels of controllable LED driving. Each of the 12 channels can deliver 20V at a maximum drive current of 700mA.

The ILA-12CHANNEL-LED-TUNER-001. has 2 modes of active operation;

- » Programmed mode
- » Standalone mode

Standalone mode gives you full control over all 12 channels, you can set the currents of all 12 channels individually. This makes setting up specific shades of white or colours easy, as they can be adjusted by simply using the buttons on the PCB. Programmed mode allows you to create a sequence of different settings for each channel with down to 100ms intervals. This allows the system to ramp up, ramp down, fade from one colour to another and so on. This is all created in excel and is imported into the ILA-

12CHANNEL-LED-TUNER-001. via a USB memory stick. Multiple profiles can be stored onto the USB key, and then viewed and selected via the on-board LCD.

The ILA-12CHANNEL-LED-TUNER-001. is aimed as a development tool to make driving complex LED systems easy, for a proof of concept or evaluation.

### TECHNICAL FEATURES

- » 12 independent 700mA, 20V channels
- » 128x64 LCD for easy control
- » Compact 165mm x 223mm desktop unit
- » User upgradeable to be able to drive all future ILS products
- » Simple press-fit output connectors
- » Requires a 24V DC external Power Supply
- » Easy to use multi coloured display
- » Easily create scenes such as sunrise or white colour sweep

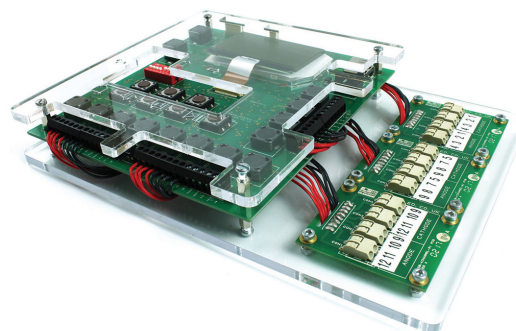

[Click here to visit our website for our latest range](#)

## THERMAL INTERFACE MATERIAL OPTIONS

ILS has a range of High-performance, cost effective Thermal Interface Materials to match perfectly their standard products. Our product fills the air pockets between the two surfaces, forming a continuous layer to conduct heat away from the LED to the Heatsink.

ILS offer our TIM in three options – double sided adhesive, single sided adhesive and nonadhesive.

Product	Non Adhesive	Single Sided Adhesive	Double Sided Adhesive
12 Die High Power Mixing LED	ILA-TIM-ILR-XM01-0A	ILA-TIM-ILR-XM01-1A	ILA-TIM-ILR-XM01-2A

Other sizes are available, including customised parts

[Click here to visit our website for our latest range](#)

## ASSEMBLY INFORMATION

- » The mounting of the 12 Die High Power Mixing LED has to be on a metal Heatsink.
- » In order to optimise the thermal management, the metal surface needs to be clean (dirt and oil free) and planar for the best contact with the LED module. A thermal grease or heat transfer material is highly recommended.

### IMPORTANT INFORMATION AND PRECAUTIONS



During operation, the LED emits ultraviolet (UV) light which is harmful to skin and eyes. UV radiation can cause sunburn, conjunctivitis and cancer. Precautions **MUST** be taken to avoid looking directly at the UV light such as the use of UV light protective glasses.



If LEDs are embedded in devices, you must add warning labels to alert users of the safety precautions required when operating devices using UV LED lights. The module's LEDs, when powered up, are very powerful. Although the light may appear off, however UV is invisible to the human eye and can still damage eyes. Thus it is advised that you do not look directly at it. Turn the module away from you and do not shine into the eyes of others. The module's LEDs, when powered up, are very powerful. Although the light may appear off, however UV is invisible to the human eye and can still damage eyes. Thus it is advised that you do not look directly at it. Turn the module away from you and do not shine into the eyes of others.



Do not operate 12 Die array with a Power Supply with unlimited current. Connection to constant voltage Power Supplies that are not current limited may cause the LEDiL Selectors to consume current above the specified maximum and cause failure or irreparable damage.



12 Die array will overheat in operation if not attached to a suitable Heatsink. Overheating can cause failure or irreparable damage.



12 Die array, when operated, can reach high temperatures thus there is risk of injury if they are touched.



**DO NOT HOT PLUG ON LED SIDE OF POWER SUPPLY.**



**DO NOT TOUCH or PUSH** on the LED as this can cause irreparable damage.



Lens discoloration may occur with prolonged exposure to UV/NUV light. Lens material will need to be tested for UV/NUV light compatibility and durability.

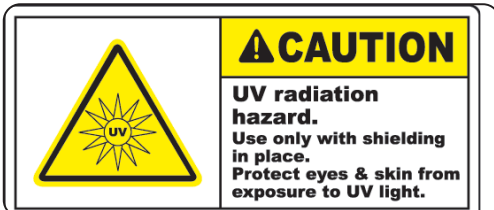

These products generate UVA radiation. The skin and eyes must be fully protected against exposure. You should be aware that UVA radiation does not eliminate harmful non-degradable substances such as heavy metals or pesticides. Assume IEC62471 Risk Group 3



## SAFETY INFORMATION



The LED module itself and all its components must not be mechanically stressed.



Assembly must not damage or destroy conducting paths on the circuit board.



The mounting of the module is carried out by attaching it at the mounting holes. Metal mounting screws must be insulated with synthetic washers to prevent circuit board damage and possible short circuiting.



To avoid mechanical damage to the connecting cables, the boards should be attached securely to the intended substrate. Heavy vibration should be avoided.



Observe correct polarity! Depending on the product, incorrect polarity will lead to emission of red or no light. The module can be destroyed!



Pay attention to standard ESD precautions when installing the 12 Die High Power Mixing LED.



The 12 Die High Power Mixing LED, as manufactured, have no conformal coating and therefore offer no inherent protection against corrosion. Damage by corrosion will not be accepted as a materials defect claim. It is the user's responsibility to provide suitable protection against corrosive agents such as moisture and condensation and other harmful elements.



For outdoor usage, a housing is definitely required to protect the board against environmental influences. The design of the housing must correspond to the IP standards in the application. It is also the responsibility of the user to ensure any housings or modifications keep the Tc junction temperature to within stated ranges.



To also ease the luminaire/installation approval, electronic control gear for LED or LED modules should carry the CE mark and be ENEC certified. In Europe the declarations of conformity must include the following standards: CE: EC 61374-2-13, EN 55015, IEC 61547 and IEC 61000-3-2 - ENEC: 61374-2-13 and IEC/EN 62384.



The evaluation of eye safety occurs according to the standard IEC 62471:2006 ("photobiological safety of lamps and lamp systems"). Within the risk grouping system of this CIE standard, the LED specified in this data sheet falls into the class "moderate risk" (exposure time 0.25s). Under real circumstances (for exposure time, eye pupils, observation distance), it is assumed that no endangerment to the eye exists from these devices. As a matter of principle, however, it should be mentioned that intense light sources have a high secondary exposure potential due to their blinding effect. As is also true when viewing other bright light sources (e.g. headlights), temporary reduction in visual acuity and afterimages can occur, leading to irritation, annoyance, visual impairment and even accidents, depending on the situation.

## FURTHER INFORMATION

The values contained in this datasheet can change due to technical innovation. Any such changes will be made without separate notification.

If you require further assistance or have an specific or custom enquiries, please contact the ILS team via email or phone. Alternatively please visit our website for more product info and to see our full ranges.



Unit 2, Berkshire Business Centre,  
Berkshire Drive, Thatcham,  
Berkshire, RG19 4EW  
+44 (0)1635 294606  
info@i-led.co.uk  
[www.i-led.co.uk](http://www.i-led.co.uk)

## ABOUT ILS

ILS offers a high level of technical skill, professionalism and commercial understanding to companies requiring market leading optoelectronics solutions. Offering conceptual advice, electronics design and manufacturing capability, we use high quality production resources both in house and in Asia, providing project support from prototyping to mass production. We also understand the need to provide cost effective solutions and we do so using high quality components to ensure that the end product's reliability and quality is uncompromised. Apart from LEDs in the visible spectrum, we have a wide range of **Infrared**, **UV LEDs**, **UV tubes**, and Lasers.

ILS is a division of **Intelligent Group Solutions Ltd** (IGS) a well-established respected industry leading Optoelectronics solutions provider. Much of IGS' business comes from providing semi-custom or custom products both in component and sub-assembly form. This comes from providing design support and prototyping within the European market place. With the capability to deliver production displays to wherever in the world that the customer's manufacturing or assembly is being undertaken.

## INTELLIGENT GROUP SOLUTIONS DIVISIONS

