

Storage Choke, high design



See below:

Approvals and Compliances

Description

- Storage choke
- THT-terminals
- Inductor vertically positioned in housing
- Constant inductance at high alternating field modulation and large DC magnetization
- Reduced magnetic reversal

Applications

- Storage of energy in switched power supplies
- Switch-mode
- Chopper amplifiers
- DC drives and stepper motor controls

Weblinks

[pdf data sheet](#), [html datasheet](#), [General Product Information](#), [Approvals](#), [Distributor-Stock-Check](#), [Detailed request for product](#), [SPICE Library](#)

Technical Data

Rated voltage	up to 600VDC	Isolation Voltage	2 kV eff., winding to ambient
Rated Current	0.45 - 4.5 A @ Ta 70 °C	Climatic Category	40/125/21 acc. to IEC 60068-1
Rated inductance	0.01 - 2 mH, Tol. ±15%	Allowable Operation Temp.	-40 °C to 125 °C
Power Operating Frequency	up to 1 MHz		
Terminal Type	THT		
Weight	4 - 30g		
Material: Housing	UL 94V-0		
Sealing Compound	UL 94V-0		

Approvals and Compliances

Detailed information on product approvals, code requirements, usage instructions and detailed test conditions can be looked up in [Details about Approvals](#)

SCHURTER products are designed for use in industrial environments. They have approvals from independent testing bodies according to national and international standards. Products with specific characteristics and requirements such as required in the automotive sector according to IATF 16949, medical technology according to ISO 13485 or in the aerospace industry can be offered exclusively with customer-specific, individual agreements by SCHURTER.





Application standards

Application standards where the product can be used

Organization	Design	Standard	Description
	Designed for applications acc.	IEC/UL 62368-1	IEC 62368-1 includes the basic requirements for safety of audio, video, information technology and office equipment.

Compliances

The product complies with following Guide Lines

Identification	Details	Initiator	Description
	CE declaration of conformity	SCHURTER AG	The CE marking declares that the product complies with the applicable requirements laid down in the harmonisation of Community legislation on its affixing in accordance with EU Regulation 765/2008.
	RoHS	SCHURTER AG	Directive RoHS 2011/65/EU, Amendment (EU) 2015/863
	China RoHS	SCHURTER AG	The law SJ / T 11363-2006 (China RoHS) has been in force since 1 March 2007. It is similar to the EU directive RoHS.
	REACH	SCHURTER AG	On 1 June 2007, Regulation (EC) No 1907/2006 on the Registration, Evaluation, Authorization and Restriction of Chemicals 1 (abbreviated as "REACH") entered into force.

Dimension [mm]

Case 01-1

Case 09-1

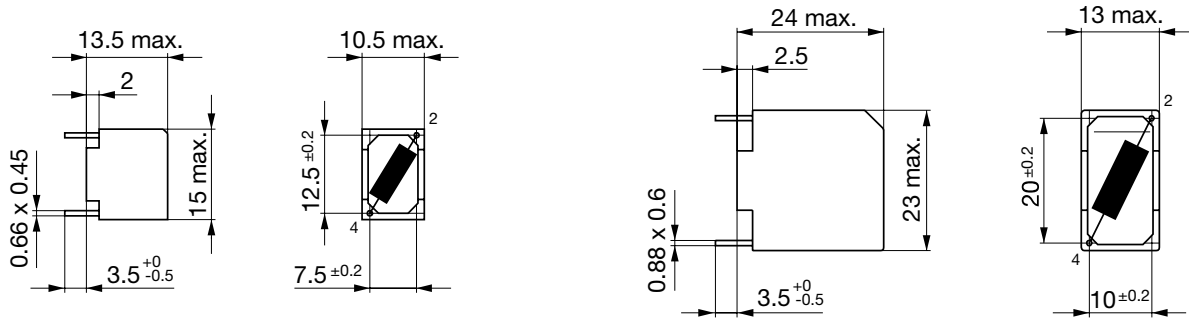

Case 19-1

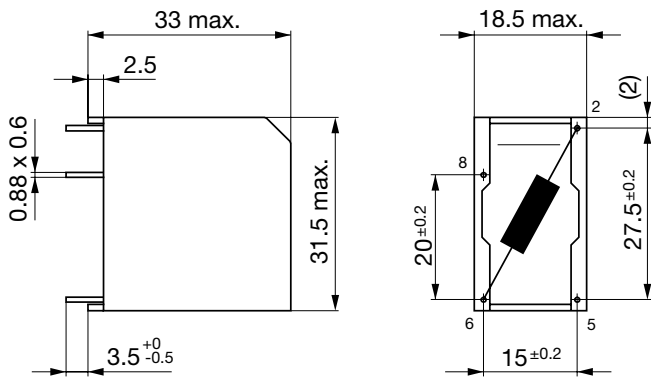

Diagrams

Application in DC-DC Converter

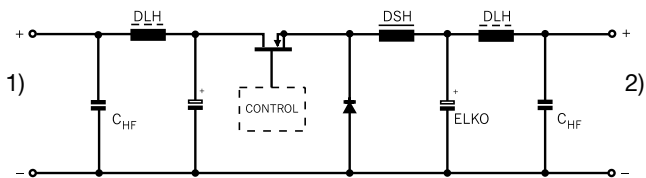

- 1) DC-Input unregulated
- 2) DC-Output regulated

Derating Curves

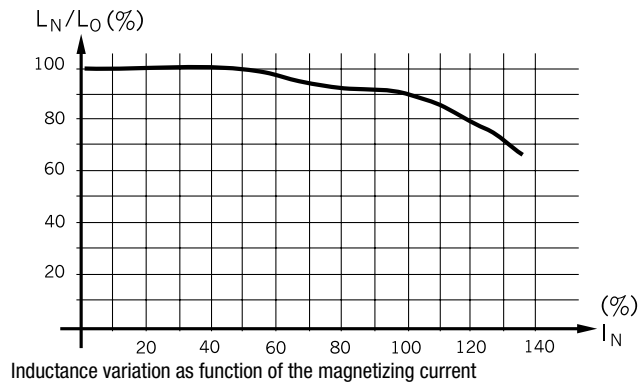

All Variants

I_n [A]	L_n [mH]	R_{cu} [mΩ]	f_{RES} [MHz]	Weight [g]	Housings	Packing unit [pcs.]	Order Number
0.6	0.14	280	8	4 g	01-1	100	DSH-14-0001
1	0.05	100	12	4 g	01-1	100	DSH-14-0002
2	0.012	25	35	4 g	01-1	100	DSH-14-0003
0.45	2	1250	0.4	14 g	09-1	50	DSH-22-0001
0.63	1	750	1.8	14 g	09-1	50	DSH-22-0002
1	0.4	300	3	14 g	09-1	50	DSH-22-0003
1.4	0.2	160	4.8	14 g	09-1	50	DSH-22-0004
1.8	0.12	90	6.5	14 g	09-1	50	DSH-22-0005
3.15	0.04	33	14	14 g	09-1	50	DSH-22-0006
4.5	0.01	8	35	14 g	09-1	50	DSH-22-0008
4.5	0.02	20	-	14 g	09-1	50	DSH-22-0007
1.6	0.5	240	2.5	29 g	19-1	70	DSH-31-0001
2	0.3	140	3.5	29 g	19-1	70	DSH-31-0002
3.15	0.15	40	-	30 g	19-1	70	DSH-31-0003
4	0.1	40	6.5	30 g	19-1	70	DSH-31-0004
4.5	0.035	15	13	30 g	19-1	70	DSH-31-0005

Most Popular.

Availability for all products can be searched real-time: <https://www.schurter.com/en/Stock-Check/Stock-Check-SCHURTER>