



Instruction Manual

READ CAREFULLY BEFORE USE
THE EQUIPMENT

CE 0082

EN 362:1993

POWERTEX

SNAP HOOK

Snap hooks with screw locking

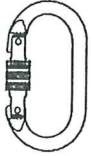

AZ 011
steel
snap hook
opening 17 mm

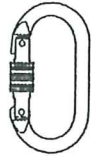

AZ 012
light alloy
snap hook
opening 17 mm



AZ 013
light alloy
snap hook
opening 21 mm

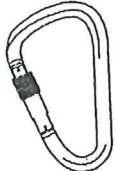

AZ 014
light alloy
snap hook
opening 25 mm



AZ 016
light alloy
snap hook
opening 20 mm



AZ 003
light alloy
snap hook
opening 20 mm

Snap hooks with double finger locking



AZ 002
steel
snap hook
opening 17 mm



AXK 10
light alloy
snap hook
opening 22 mm

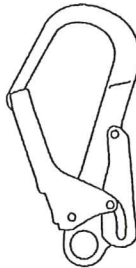

AZ 022
steel
big snap hook
opening 50 mm

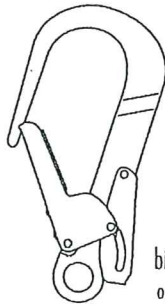

AZ 023
light alloy
big snap hook
opening 55 mm



AZ 005
steel
snap hook
opening 18 mm

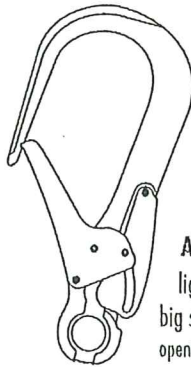

AZ 024
light alloy
big snap hook
opening 110 mm

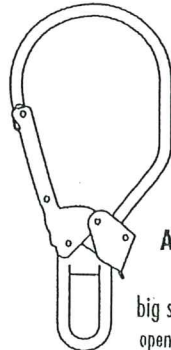

AZ 025
steel
big snap hook
opening 85 mm

Snap hooks with automatic locking "twist-lock"

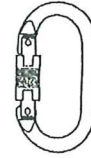

AZ 011
steel
snap hook
opening 17 mm

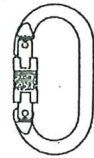

AZ 012
light alloy
snap hook
opening 17 mm



AZ 013
light alloy
snap hook
opening 21 mm



AZ 004
light alloy
snap hook
opening 20 mm

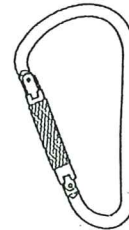

AZ 111
light alloy
snap hook
opening 42 mm



AZ 015
light alloy
snap hook
opening 23 mm

The snap hook is a component of the personal protective equipment against falls from a height which complies with EN362. The snap hook is used to connecting the individual parts of the fall arrest equipment in the one complete system. The snap hook can be the integral part of the fall arrest equipment component (safety lanyard for example) or can be the independent component of the fall arrest system (as a connector for the fall arresters, working ropes, etc.).

BASIC EQUIPMENT

- 1 body
- 2 gate
- 3 locking gear

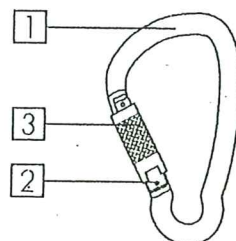
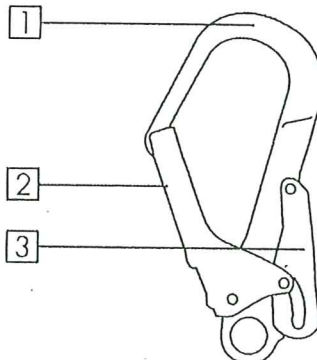
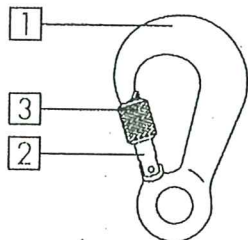

BASIC RULES OF USING THE SNAP HOOK

- before each use, a close visual examination of the snap hook components (body, gate, locking gear) must be carried out in respect of mechanical, chemical and thermal defects. The examination must be done by a person who is going to use the snap hook. In the case of any defect or doubt of correct condition of the snap hook do not use the snap hook.
- using the snap hook, in connection with fall arrest system, must be compatible with manual instructions of the fall arrest systems and obligatory standards:
 - EN361 - for the safety harness;
 - EN353-1, EN353-2, EN355, EN354, EN360 - for the fall arrest systems;
 - EN341 - for the rescue equipment;
 - EN358 - for the work positioning equipment.
- the snap hooks with manual locking (for example screw locking) shall be acceptable only in cases where the user does not have to attach and remove the snap hook many times a working day.
- during use the snap hook must be protected from a contact with acids, solvents, basics, open fire, hot metal drops and sharp edges. If you have any doubts about the conditions where the snap hook will be used, ask the producer.
- structural anchor point to which will be connected the snap hook should be situated above working position and should have static resistance min. 15kN. It is recommended to use certified and marked structural anchor point complied with EN 795.
- before use the fall arrest system, the rescue operation must be introduced to avoid any danger that can happened during using the equipment.
- the shape of the structural anchor point should not let self-acting snap hook disconnection see the drawings:

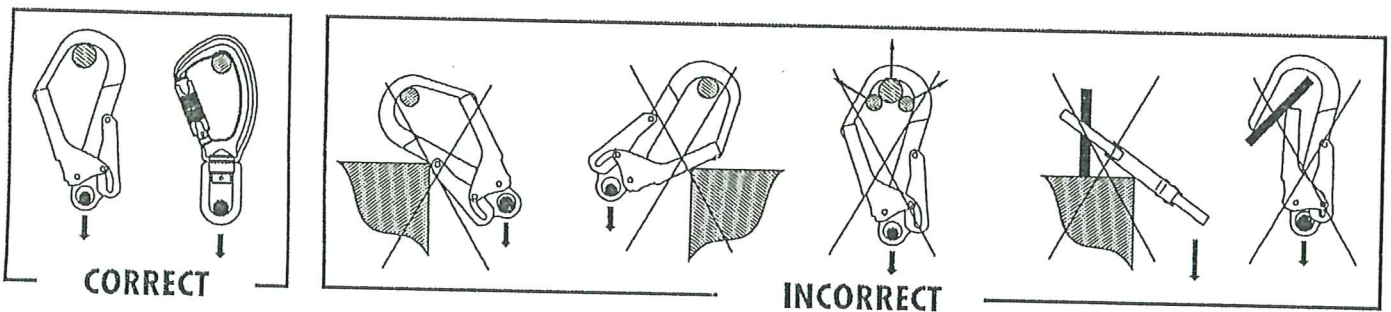

- necessarily protect the snap hook gate with locking gear - see the drawings:

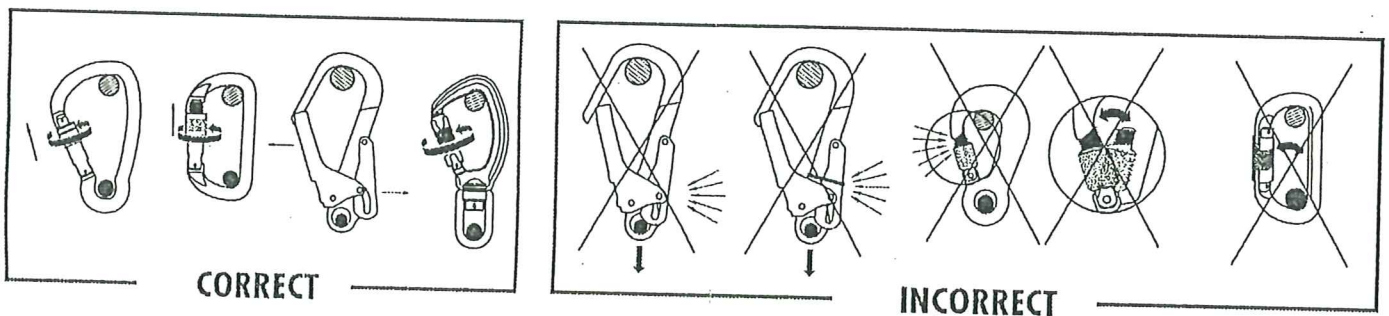

CONTENT OF THE SNAP HOOK MARKING

reference number of the device ————— AXK 10

CE mark and identity number
of the authorized body
responsible for controlling manufacture of the device — **CE** 0082

number of the manufacturing series
(month/year or year of the device manufacture) — 03/01 (or 2001)

marking of the manufacturer —————  or distributor

EN 362:1993 — European norm
(number/year)

 — necessity of knowledge
the instruction manual
before using the device

THE ESSENTIAL PRINCIPLES FOR USERS OF PERSONAL PROTECTIVE EQUIPMENT AGAINST FALLS FROM A HEIGHT

- personal protective equipment shall only be used by a person trained and competent in its safe use.
- personal protective equipment must not be used by a person with medical condition that could affect the safety of the equipment user in normal and emergency use.
- a rescue plan shall be in place to deal with any emergencies that could arise during the work.
- it is forbidden to make any alterations or additions to the equipment without the manufacturer's prior written consent.
- any repair shall only be carried out by equipment manufacturer or his certified representative.
- personal protective equipment shall not be used outside its limitations, or for any purpose other than that for which it is intended.
- personal protective equipment should be a personal issue item.
- before use ensure about the compatibility of items of equipment assembled into a fall arrest system. Periodically check connecting and adjusting of the equipment components to avoid accidental loosening or disconnecting of the components.
- it is forbidden to use combinations of items of equipment in which the safe function of any one item is affected by or interferes with the safe function of another.
- before each use of personal protective equipment it is obligatory to carry out a pre-use check of the equipment, to ensure that it is in a serviceable condition and operates correctly before it is used.
- during pre-use check it is necessary to inspect all elements of the equipment in respect of any damages, excessive wear, corrosion, abrasion, cutting or incorrect acting, especially take into consideration:
 - in full body harnesses and belts - buckles, adjusting elements, attaching points, webbings, seams, loops;
 - in energy absorbers - attaching loops, webbing, seams, casing, connectors;
 - in textile lanyards or lifelines or guidelines - rope, loops, thimbles, connectors, adjusting element, splices;
 - in steel lanyards or lifelines or guidelines - cable, wires, clips, ferrules, loops, thimbles, connectors, adjusting elements;
 - in retractable fall arresters - cable or webbing, retractor and brake proper acting, casing, energy absorber, connector;
 - in guided type fall arresters - body of the fall arrester, sliding function, locking gear acting, rivets and screws, connector, energy absorber;
 - in connectors - main body, rivets, gate, locking gear acting.
- after every 12 months of utilization, personal protective equipment must be withdrawn from use to carry out periodical detailed inspection. The periodic inspection must be carried out by a competent person for periodic inspection. The periodic inspection can be carried out also by the manufacturer or his authorized representative. In case of some types of the complex equipment e.g. some types of retractable fall arresters the annual inspection can be carried out only by the manufacturer or his authorized representative.
- regular periodic inspections are the essential for equipment maintenance and the safety of the users which depends upon the continued efficiency and durability of the equipment.
- during periodic inspection it is necessary to check the legibility of the equipment marking.
- it is essential for the safety of the user that if the product is re-sold outside the original country of destination the reseller shall provide instructions for use, for maintenance, for periodic examination and for repair in language of the country in which the product is to be used.
- personal protective equipment must be withdrawn from use immediately when any doubt arise about its condition for safe use and not used again until confirmed in writing by equipment manufacturer or his representative after carried out the detailed inspection.
- personal protective equipment must be withdrawn from use immediately and destroyed when it have been used to arrest a fall;
- a full body harness is the only acceptable body holding device that can be used in a fall arrest system.
- in full body harness use only attaching points marked with big letter "A" to attach a fall arrest system. Marking like "A/2" or a half of "A" means the necessity of attaching a fall arrest system to both attaching points together simultaneously. It is strictly forbidden to attach a fall arrest system to the single attaching point marked "A/2" or a half of "A". See drawings below:

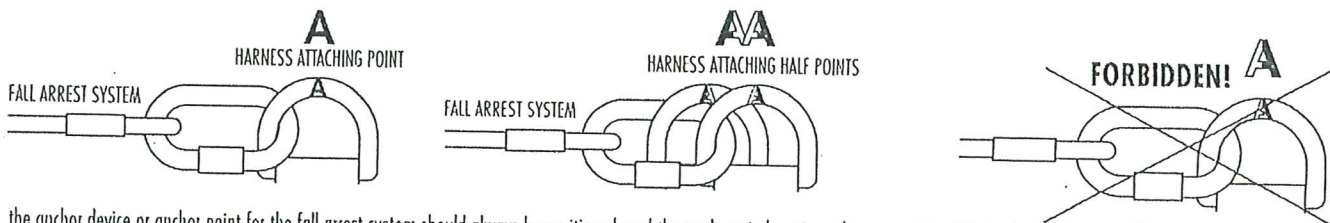

- the anchor device or anchor point for the fall arrest system should always be positioned, and the work carried out in such a way, as to minimise both the potential for falls and potential fall distance. The anchor device/point should be placed above the position of the user. The shape and construction of the anchor device/point shall not allowed to self-acting disconnection of the equipment. Minimal static strength of the anchor device/point is 15 kN. It is recommended to use certified and marked structural anchor point complied with EN795.
- it is obligatory to verify the free space required beneath the user at the workplace before each occasion of use the fall arrest system, so that, in the case of a fall, there will be no collision with the ground or other obstacle in the fall path. The required value of the free space should be taken from instruction manual of used equipment.
- there are many hazards that may affect the performance of the equipment and corresponding safety precautions that have to be observed during equipment utilization, especially:
 - trailing or looping of lanyards or lifelines over sharp edges,
 - any defects like cutting, abrasion, corrosion,
 - climatic exposure,
 - pendulum falls,
 - extremes of temperature,
 - chemical reagents,
 - electrical conductivity.
- personal protective equipment must be transported in the package (e.g.: bag made of moisture-proof textile or foil bag or cases made of steel or plastic) to protect it against damage or moisture.
- the equipment can be cleaned without causing adverse effect on the materials in the manufacture of the equipment. For textile products use mild detergents for delicate fabrics, wash by hand or in a machine and rinse in water. Plastic parts can be cleaned only with water. When the equipment becomes wet, either from being in use or when due cleaning, it shall be allowed to dry naturally, and shall be kept away from direct heat. In metallic products some mechanic parts (spring, pin, hinge, etc.) can be regularly slightly lubricated to ensure better operation. Other maintenance and cleaning procedures should be adhered to detailed instructions stated in the manual of the equipment.
- personal protective equipment should be stored loosely packed, in a well-ventilated place, protected from direct light, ultraviolet degradation, damp environment, sharp edges, extreme temperatures and corrosive or aggressive substances.

ADMISSIBLE TIME OF USE

The snap hook can be used for 5 years. After this period the device must be withdrawn from use to carry out manufacturer's detailed inspection.

The manufacturer's inspection can be carried out by:

- manufacturer
- or person recommended by manufacturer
- or company recommended by manufacturer.

During this inspection will be established admissible time of the snap hook use till next manufacturer's inspection.

The snap hook must be withdrawn from use immediately and destroyed when it have been used to arrest a fall.

IT IS THE RESPONSIBILITY OF THE USER ORGANISATION TO PROVIDE THE IDENTITY CARD AND TO FILL IN THE DETAILS REQUIRED.

THE IDENTITY CARD SHOULD BE FILLED IN BEFORE THE FIRST USE BY A COMPETENT PERSON, RESPONSIBLE IN THE USER ORGANIZATION FOR PROTECTIVE EQUIPMENT.

ANY INFORMATION ABOUT THE EQUIPMENT LIKE PERIODIC INSPECTIONS, REPAIRS, REASONS OF EQUIPMENT'S WITHDRAWN FROM USE SHALL BE NOTED INTO THE IDENTITY CARD BY A COMPETENT PERSON.

THE IDENTITY CARD SHOULD BE STORED DURING A WHOLE PERIOD OF EQUIPMENT UTILIZATION.

DO NOT USE THE EQUIPMENT WITHOUT THE IDENTITY CARD.

ALL RECORDS IN THE IDENTITY CARD CAN BE FILLED IN ONLY BY A COMPETENT PERSON.

IDENTITY CARD

MODEL AND TYPE OF EQUIPMENT	
-----------------------------	--

REF. NUMBER	
-------------	--

SERIAL NUMBER		DATE OF MANUF.	
---------------	--	----------------	--

USER NAME	
-----------	--

DATE OF PUTTING INTO OPERATION	
--------------------------------	--

DATE OF PURCHASE	
------------------	--

PERIODIC EXAMINATION AND REPAIR HISTORY

	DATE	REASON FOR ENTRY PERIODIC EXAMINATION OR REPAIR	DEFECTS NOTED, REPAIRS CARRIED OUT AND OTHER REVELANT INFORMATIONS	NAME AND SIGNATURE OF COMPETENT PERSON	PERIODIC EXAMINATION NEXT DUE DATE
1					
2					
3					
4					

EC type examination carried out by CETE APAVE SUDEUROPE, BP 193, 13322 Marseille, France - 0082

CERTEX UK ; Unit C1, Harworth Industrial Estate, Bryans Close, Harworth, Doncaster, DN11 8RY

www.certex.co.uk