

**Presse-étoupe laiton nickelé  
filetage métrique court  
joint long**



**Progress MS**

**MS**

**Matière**  
**joint intérieur :** laiton nickelé  
**joint torique :** TPE  
 NBR

**Températures d'utilisation :** -40 à +100°C

**Résistance à la traction :** selon EN 50262  
 version A



Référence article	 G	∅ mm	 mm	H mm	L mm
-------------------	---	---------	--	---------	---------

**Joint long en une partie**

A1060.06.025	M 6x1	2,0 - 2,5	8	12	5
A1060.06.030	M 6x1	2,5 - 3,0	8	12	5
A1060.08.030	M 8x1,25	2,5 - 3,0	11	14	5
A1060.08.040	M 8x1,25	3,0 - 4,0	11	14	5
A1060.10.040	M10x1,5	3,0 - 4,0	13	15	5
A1060.10.060	M10x1,5	4,0 - 6,0	13	15	5
A1060.12.050	M12x1,5	3,5 - 5,0	15	17	5
A1060.12.065	M12x1,5	5,0 - 6,5	15	17	5
A1060.12.075	M12x1,5	6,5 - 7,5	15	17	5
A1060.17.060	M16x1,5	4,5 - 6,0	18	20	5
A1060.17.080	M16x1,5	6,0 - 8,0	18	20	5
A1060.17.105	M16x1,5	8,0 - 10,5	18	22	5
A1060.20.080	M20x1,5	6,0 - 8,0	24	21	6
A1060.20.110	M20x1,5	8,0 - 11,0	24	21	6
A1060.20.145	M20x1,5	11,0 - 14,5	24	23	6
A1060.25.125	M25x1,5	9,5 - 12,5	30	25	7
A1060.25.160	M25x1,5	12,5 - 16,0	30	25	7
A1060.25.190	M25x1,5	16,0 - 19,0	30	28	7
A1060.32.210	M32x1,5	17,0 - 21,0	36	28	8
A1060.32.255	M32x1,5	21,0 - 25,5	36	28	8
A1060.40.285	M40x1,5	24,0 - 28,5	46	31	8
A1060.40.330	M40x1,5	28,5 - 33,0	46	31	8
A1060.50.370	M50x1,5	33,0 - 37,0	55	34	9
A1060.50.420	M50x1,5	37,0 - 42,0	55	34	9
A1060.63.460	M63x1,5	40,0 - 46,0	70	37	10
A1060.63.520	M63x1,5	46,0 - 52,0	70	37	10
A1060.75.560	M75x1,5	50,0 - 56,0	80	38	11
A1060.75.630	M75x1,5	56,0 - 63,0	80	38	11

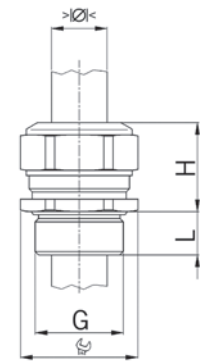

**Joint long en deux parties**

A1060.17	M16x1,5	6,0 - 10,5	18	22	5
A1060.20	M20x1,5	8,0 - 14,5	24	23	6
A1060.25	M25x1,5	12,5 - 19,0	30	28	7
A1060.32	M32x1,5	17,0 - 25,5	36	28	8
A1060.40	M40x1,5	24,0 - 33,0	46	31	8
A1060.50	M50x1,5	33,0 - 42,0	55	34	9
A1060.63	M63x1,5	40,0 - 52,0	70	37	10
A1060.75	M75x1,5	50,0 - 63,0	80	38	11

**Presse-étoupe laiton nickelé**  
**filetage métrique court**  
**joint court**



**Progress MS**

**MS**

**Matière**  
 joint intérieur : laiton nickelé  
 joint torique : TPE  
 NBR

**Températures d'utilisation :** -40 à +100°C

**Résistance à la traction :** selon EN 50262  
 version A

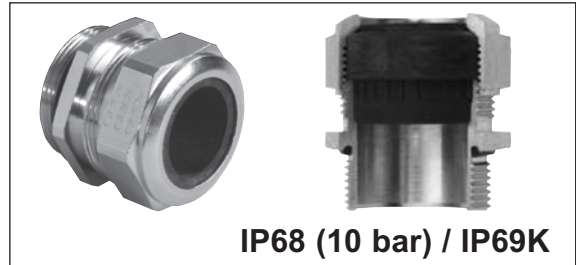

Référence article	G	Ø	mm	H	L
-------------------	---	---	----	---	---

**Joint court en une partie**

A1000.06.025	M 6x1	2,0 - 2,5	8	12	5
A1000.06.030	M 6x1	2,5 - 3,0	8	12	5
A1000.06.035	M 6x1	3,0 - 3,5	8	12	5
A1000.08.035	M 8x1,25	2,5 - 3,5	11	14	5
A1000.08.050	M 8x1,25	3,5 - 5,0	11	14	5
A1000.10.040	M10x1,5	3,0 - 4,0	13	15	5
A1000.10.060	M10x1,5	4,0 - 6,0	13	15	5
A1000.12.050	M12x1,5	3,5 - 5,0	15	17	5
A1000.12.065	M12x1,5	5,0 - 6,5	15	17	5
A1000.12.080	M12x1,5	6,5 - 8,0	15	17	5
A1000.17.045	M16x1,5	3,5 - 4,5	18	20	5
A1000.17.060	M16x1,5	4,5 - 6,0	18	20	5
A1000.17.080	M16x1,5	6,0 - 8,0	18	20	5
A1000.17.105	M16x1,5	8,0 - 10,5	18	22	5
A1000.20.080	M20x1,5	6,0 - 8,0	24	21	6
A1000.20.110	M20x1,5	8,0 - 11,0	24	21	6
A1000.20.150	M20x1,5	11,0 - 15,0	24	23	6
A1000.25.125	M25x1,5	9,5 - 12,5	30	25	7
A1000.25.160	M25x1,5	12,5 - 16,0	30	27	7
A1000.25.205	M25x1,5	16,0 - 20,5	30	28	7
A1000.32.170	M32x1,5	14,0 - 17,0	36	28	8
A1000.32.210	M32x1,5	17,0 - 21,0	36	28	8
A1000.32.255	M32x1,5	21,0 - 25,5	36	28	8
A1000.40.240	M40x1,5	20,0 - 24,0	46	31	8
A1000.40.285	M40x1,5	24,0 - 28,5	46	31	8
A1000.40.330	M40x1,5	28,5 - 33,0	46	31	8
A1000.50.330	M50x1,5	29,0 - 33,0	55	34	9
A1000.50.370	M50x1,5	33,0 - 37,0	55	34	9
A1000.50.420	M50x1,5	37,0 - 42,0	55	34	9
A1000.63.400	M63x1,5	35,0 - 40,0	70	37	10
A1000.63.460	M63x1,5	40,0 - 46,0	70	37	10
A1000.63.520	M63x1,5	46,0 - 52,0	70	37	10
A1000.75.500	M75x1,5	45,0 - 50,0	80	38	11
A1000.75.560	M75x1,5	50,0 - 56,0	80	38	11
A1000.75.630	M75x1,5	56,0 - 63,0	80	38	11
A1000.85.700	M85x2,0	63,0 - 70,0	95	41	18
A1000.95.750	M95x2,0	68,0 - 75,0	110	51	20
A1000.95.800	M95x2,0	73,0 - 80,0	110	51	20
A1000.100.850	M100x3,0	78,0 - 85,0	115	51	22
A1000.105.900	M105x3,0	83,0 - 90,0	120	52	22
A1000.115.950	M115x3,0	88,0 - 95,0	125	52	22

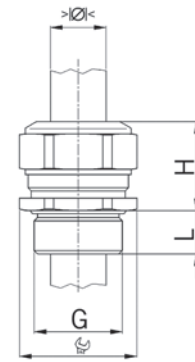

**Joint court en deux parties**

A1000.17	M16x1,5	6,0 - 10,5	18	22	5
A1000.20	M20x1,5	8,0 - 15,0	24	23	6
A1000.25	M25x1,5	12,5 - 20,5	30	28	7
A1000.32	M32x1,5	17,0 - 25,5	36	28	8
A1000.40	M40x1,5	24,0 - 33,0	46	31	8
A1000.50	M50x1,5	33,0 - 42,0	55	34	9
A1000.63	M63x1,5	40,0 - 52,0	70	37	10
A1000.75	M75x1,5	50,0 - 63,0	80	38	11

**Presse-étoupe laiton nickelé  
filetage métrique long  
joint long**



**Progress MS**

**MS**

**Matière**  
joint intérieur : laiton nickelé  
joint torique : TPE  
NBR

**Températures d'utilisation :** -40 à +100°C

**Résistance à la traction :** selon EN 50262  
version A



Référence article	 G	∅ mm	 mm	H mm	L mm
-------------------	---	---------	--	---------	---------

**Joint long en une partie**

A1160.06.025	M 6x1	2,0 - 2,5	8	12	8
A1160.06.030	M 6x1	2,5 - 3,0	8	12	8
A1160.08.030	M 8x1,25	2,5 - 3,0	11	14	10
A1160.08.040	M 8x1,25	3,0 - 4,0	11	14	10
A1160.10.040	M10x1,5	3,0 - 4,0	13	15	10
A1160.10.060	M10x1,5	4,0 - 6,0	13	15	10
A1160.12.050	M12x1,5	3,5 - 5,0	15	17	10
A1160.12.065	M12x1,5	5,0 - 6,5	15	17	10
A1160.12.075	M12x1,5	6,5 - 7,5	15	17	10
A1160.17.105	M16x1,5	8,0 - 10,5	18	22	10
A1160.20.145	M20x1,5	11,0 - 14,5	24	23	10
A1160.25.190	M25x1,5	16,0 - 19,0	30	28	11
A1160.32.255	M32x1,5	21,0 - 25,5	36	28	13
A1160.40.330	M40x1,5	28,5 - 33,0	46	34	13
A1160.50.420	M50x1,5	37,0 - 42,0	55	34	14
A1160.63.520	M63x1,5	46,0 - 52,0	70	37	14
A1160.75.630	M75x1,5	56,0 - 63,0	80	38	15

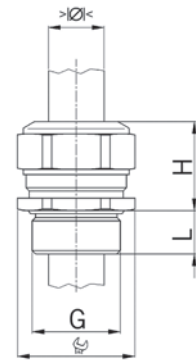

**Joint long en deux parties**

A1160.17	M16x1,5	6,0 - 10,5	18	22	10
A1160.20	M20x1,5	8,0 - 14,5	24	23	10
A1160.25	M25x1,5	12,5 - 19,0	30	28	11
A1160.32	M32x1,5	17,0 - 25,5	36	28	13
A1160.40	M40x1,5	24,0 - 33,0	46	31	13
A1160.50	M50x1,5	33,0 - 42,0	55	34	14
A1160.63	M63x1,5	40,0 - 52,0	70	37	14
A1160.75	M75x1,5	50,0 - 63,0	80	38	15



# Presse-étoupe laiton nickelé filetage métrique long joint court



Progress MS

MS

**Matière**  
joint intérieur : laiton nickelé  
joint torique : TPE  
NBR

**Températures d'utilisation :** -40 à +100°C

**Résistance à la traction :** selon EN 50262  
version A

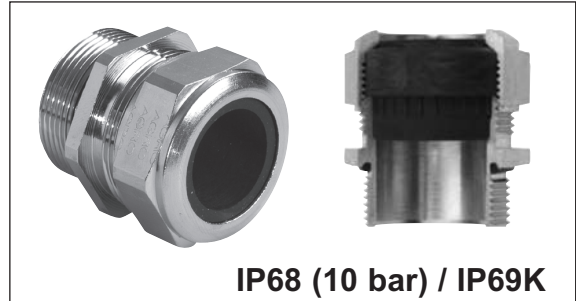

Référence article		Ø		H	L
	G	mm	mm	mm	mm

## Joint court en une partie

A1100.06.025	M 6x1	2,0 - 2,5	8	12	8
A1100.06.030	M 6x1	2,5 - 3,0	8	12	8
A1100.06.035	M 6x1	3,0 - 3,5	8	12	8
A1100.08.035	M 8x1,25	2,5 - 3,5	11	14	10
A1100.08.050	M 8x1,25	3,5 - 5,0	11	14	10
A1100.10.040	M10x1,5	3,0 - 4,0	13	15	10
A1100.10.060	M10x1,5	4,0 - 6,0	13	15	10
A1100.12.050	M12x1,5	3,5 - 5,0	15	17	10
A1100.12.065	M12x1,5	5,0 - 6,5	15	17	10
A1100.12.080	M12x1,5	6,5 - 8,0	15	17	10
A1100.17.045	M16x1,5	3,5 - 4,5	18	20	10
A1100.17.060	M16x1,5	4,5 - 6,0	18	20	10
A1100.17.080	M16x1,5	6,0 - 8,0	18	20	10
A1100.17.105	M16x1,5	8,0 - 10,5	18	22	10
A1100.20.080	M20x1,5	6,0 - 8,0	24	21	10
A1100.20.110	M20x1,5	8,0 - 11,0	24	21	10
A1100.20.150	M20x1,5	11,0 - 15,0	24	23	10
A1100.25.125	M25x1,5	9,5 - 12,5	30	25	11
A1100.25.160	M25x1,5	12,5 - 16,0	30	27	11
A1100.25.205	M25x1,5	16,0 - 20,5	30	28	11
A1100.32.170	M32x1,5	14,0 - 17,0	36	28	13
A1100.32.210	M32x1,5	17,0 - 21,0	36	28	13
A1100.32.255	M32x1,5	21,0 - 25,5	36	28	13
A1100.40.240	M40x1,5	20,0 - 24,0	46	31	13
A1100.40.285	M40x1,5	24,0 - 28,5	46	31	13
A1100.40.330	M40x1,5	28,5 - 33,0	46	31	13
A1100.50.330	M50x1,5	29,0 - 33,0	55	34	14
A1100.50.370	M50x1,5	33,0 - 37,0	55	34	14
A1100.50.420	M50x1,5	37,0 - 42,0	55	34	14
A1100.63.400	M63x1,5	35,0 - 40,0	70	37	14
A1100.63.460	M63x1,5	40,0 - 46,0	70	37	14
A1100.63.520	M63x1,5	46,0 - 52,0	70	37	14
A1100.75.500	M75x1,5	45,0 - 50,0	80	38	15
A1100.75.560	M75x1,5	50,0 - 56,0	80	38	15
A1100.75.630	M75x1,5	56,0 - 63,0	80	38	15

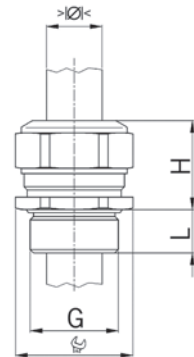

## Joint court en deux parties

A1100.17	M16x1,5	6,0 - 10,5	18	22	10
A1100.20	M20x1,5	8,0 - 15,0	24	23	10
A1100.25	M25x1,5	12,5 - 20,5	30	28	11
A1100.32	M32x1,5	17,0 - 25,5	36	28	13
A1100.40	M40x1,5	24,0 - 33,0	46	31	13
A1100.50	M50x1,5	33,0 - 42,0	55	34	14
A1100.63	M63x1,5	40,0 - 52,0	70	37	14
A1100.75	M75x1,5	50,0 - 63,0	80	38	15

**Presse-étoupe laiton nickelé  
filetage Pg court  
joint long**



**Progress MS**

**MS**

**Matière**  
**joint intérieur :** laiton nickelé  
**joint torique :** TPE  
 NBR  
**Températures d'utilisation :** -40 à +100°C



Référence article		Ø		H	L
	G	mm	mm	mm	mm

**Joint long en une partie**

A1060.07.050	Pg 7	3,5 - 5,0	15	17	6
A1060.07.065	Pg 7	5,0 - 6,5	15	17	6
A1060.07.075	Pg 7	6,5 - 7,5	15	17	6
A1060.09.060	Pg 9	4,5 - 6,0	18	20	6
A1060.09.080	Pg 9	6,0 - 8,0	18	20	6
A1060.09.105	Pg 9	8,0 - 10,5	18	22	6
A1060.11.055	Pg 11	4,0 - 5,5	21	21	6
A1060.11.085	Pg 11	5,5 - 8,5	21	21	6
A1060.11.120	Pg 11	8,5 - 12,0	21	21	6
A1060.13.080	Pg 13	6,0 - 8,0	24	21	6
A1060.13.110	Pg 13	8,0 - 11,0	24	21	6
A1060.13.145	Pg 13	11,0 - 14,5	24	23	6
A1060.16.080	Pg 16	6,0 - 8,0	24	23	6
A1060.16.110	Pg 16	8,0 - 11,0	24	23	6
A1060.16.145	Pg 16	11,0 - 14,5	24	23	6
A1060.21.125	Pg 21	9,5 - 12,5	30	28	7,5
A1060.21.160	Pg 21	12,5 - 16,0	30	28	7,5
A1060.21.190	Pg 21	16,0 - 19,0	30	28	7,5
A1060.29.230	Pg 29	19,0 - 23,0	38	28	8
A1060.29.275	Pg 29	23,0 - 27,5	38	28	8
A1060.36.305	Pg 36	26,0 - 30,5	50	32	8
A1060.36.350	Pg 36	30,5 - 35,0	50	32	8
A1060.42.370	Pg 42	33,0 - 37,0	55	34	10
A1060.42.420	Pg 42	37,0 - 42,0	55	34	10
A1060.48.430	Pg 48	37,0 - 43,0	65	37	11
A1060.48.490	Pg 48	43,0 - 49,0	65	37	11

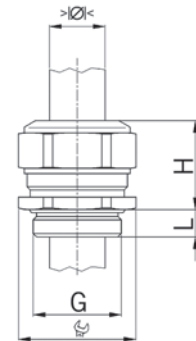

**Joint long en deux parties**

A1060.09	Pg 9	6,0 - 10,5	18	22	6
A1060.11	Pg 11	5,5 - 12,0	21	21	6
A1060.13	Pg 13	8,0 - 14,5	24	23	6
A1060.16	Pg 16	8,0 - 14,5	24	23	6
A1060.21	Pg 21	12,5 - 19,0	30	28	7,5
A1060.29	Pg 29	19,0 - 27,5	38	28	8
A1060.36	Pg 36	26,0 - 35,0	50	32	8
A1060.42	Pg 42	33,0 - 42,0	55	34	10
A1060.48	Pg 48	37,0 - 49,0	65	37	11



**Presse-étoupe laiton nickelé  
filetage Pg court  
joint court**



**Progress MS**

**MS**

**Matière**  
**joint intérieur :** laiton nickelé  
**joint torique :** TPE  
 NBR  
**Températures d'utilisation :** -40 à +100°C



Référence article		Ø mm		H mm	L mm
-------------------	---	---------	---	---------	---------

**Joint court en une partie**

A1000.07.050	Pg 7	3,5 - 5,0	15	17	6
A1000.07.065	Pg 7	5,0 - 6,5	15	17	6
A1000.07.080	Pg 7	6,5 - 8,0	15	17	6
A1000.09.045	Pg 9	3,5 - 4,5	18	20	6
A1000.09.060	Pg 9	4,5 - 6,0	18	20	6
A1000.09.080	Pg 9	6,0 - 8,0	18	20	6
A1000.09.105	Pg 9	8,0 - 10,5	18	22	6
A1000.11.055	Pg 11	4,0 - 5,5	21	21	6
A1000.11.085	Pg 11	5,5 - 8,5	21	21	6
A1000.11.120	Pg 11	8,5 - 12,0	21	21	6
A1000.13.080	Pg 13	6,0 - 8,0	24	21	6
A1000.13.110	Pg 13	8,0 - 11,0	24	21	6
A1000.13.150	Pg 13	11,0 - 15,0	24	23	6
A1000.16.080	Pg 16	6,0 - 8,0	24	23	6
A1000.16.110	Pg 16	8,0 - 11,0	24	23	6
A1000.16.150	Pg 16	11,0 - 15,0	24	23	6
A1000.21.125	Pg 21	9,5 - 12,5	30	28	7,5
A1000.21.160	Pg 21	12,5 - 16,0	30	28	7,5
A1000.21.205	Pg 21	16,0 - 20,5	30	28	7,5
A1000.29.190	Pg 29	16,0 - 19,0	38	28	8
A1000.29.230	Pg 29	19,0 - 23,0	38	28	8
A1000.29.275	Pg 29	23,0 - 27,5	38	28	8
A1000.36.260	Pg 36	21,5 - 26,0	50	32	8
A1000.36.305	Pg 36	26,0 - 30,5	50	32	8
A1000.36.350	Pg 36	30,5 - 35,0	50	32	8
A1000.42.330	Pg 42	29,0 - 33,0	50	34	10
A1000.42.370	Pg 42	33,0 - 37,0	55	34	10
A1000.42.420	Pg 42	37,0 - 42,0	55	34	10
A1000.48.370	Pg 48	32,0 - 37,0	65	37	11
A1000.48.430	Pg 48	37,0 - 43,0	65	37	11
A1000.48.490	Pg 48	43,0 - 49,0	65	37	11

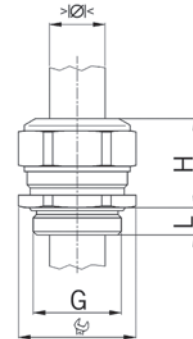

**Joint court en deux parties**

A1000.09	Pg 9	6,0 - 10,5	18	22	6
A1000.11	Pg 11	5,5 - 12,0	21	21	6
A1000.13	Pg 13	8,0 - 15,0	24	23	6
A1000.16	Pg 16	8,0 - 15,0	24	23	6
A1000.21	Pg 21	12,5 - 20,5	30	28	7,5
A1000.29	Pg 29	19,0 - 27,5	38	28	8
A1000.36	Pg 36	26,0 - 35,0	50	32	8
A1000.42	Pg 42	33,0 - 42,0	55	34	10
A1000.48	Pg 48	37,0 - 49,0	65	37	11

**Presse-étoupe laiton nickelé  
filetage Pg long  
joint long**



**Progress MS**

**MS**

**Matière**  
 joint intérieur : laiton nickelé  
 joint torique : TPE  
 NBR  
**Températures d'utilisation :** -40 à +100°C

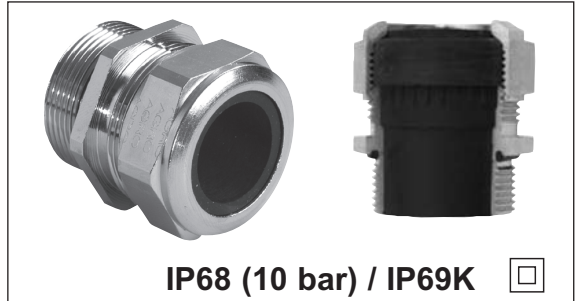

Référence article	 G	Ø mm	 mm	H mm	L mm
-------------------	---	---------	--	---------	---------

**Joint long en une partie**

A1160.07.065	Pg 7	5,0 - 6,5	15	17	10
A1160.07.075	Pg 7	6,5 - 7,5	15	17	10
A1160.09.105	Pg 9	8,0 - 10,5	18	22	10
A1160.11.120	Pg 11	8,5 - 12,0	21	21	10
A1160.13.145	Pg 13	11,0 - 14,5	24	23	10
A1160.16.145	Pg 16	11,0 - 14,5	24	23	10
A1160.21.190	Pg 21	16,0 - 19,0	30	28	12
A1160.29.275	Pg 29	23,0 - 27,5	38	28	12
A1160.36.350	Pg 36	30,5 - 35,0	50	32	15
A1160.42.420	Pg 42	37,0 - 42,0	55	32	15
A1160.48.490	Pg 48	43,0 - 49,0	65	37	15

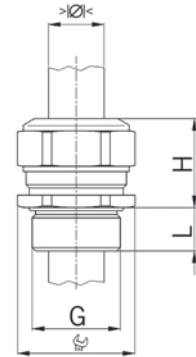

**Joint long en deux parties**

A1160.09	Pg 9	6,0 - 10,5	18	22	10
A1160.11	Pg 11	5,5 - 12,0	21	21	10
A1160.13	Pg 13	8,0 - 14,5	24	23	10
A1160.16	Pg 16	8,0 - 14,5	24	23	10
A1160.21	Pg 21	12,5 - 19,0	30	28	12
A1160.29	Pg 29	19,0 - 27,5	38	28	12
A1160.36	Pg 36	26,0 - 35,0	50	32	15
A1160.42	Pg 42	33,0 - 42,0	55	34	15
A1160.48	Pg 48	37,0 - 49,0	65	37	15



**Presse-étoupe laiton nickelé  
filetage Pg long  
joint court**



**Progress MS**

**MS**

**Matière**  
**joint intérieur :** laiton nickelé  
**joint torique :** TPE  
 NBR  
**Températures d'utilisation :** -40 à +100°C



Référence article	 G	∅ mm	 mm	H mm	L mm
-------------------	---	---------	--	---------	---------

**Joint court en une partie**

A1100.07.050	Pg 7	3,5 - 5,0	15	17	10
A1100.07.065	Pg 7	5,0 - 6,5	15	17	10
A1100.07.080	Pg 7	6,5 - 8,0	15	17	10
A1100.09.045	Pg 9	3,5 - 4,5	18	20	10
A1100.09.060	Pg 9	4,5 - 6,0	18	20	10
A1100.09.080	Pg 9	6,0 - 8,0	18	20	10
A1100.09.105	Pg 9	8,0 - 10,5	18	22	10
A1100.11.055	Pg 11	4,0 - 5,5	21	21	10
A1100.11.085	Pg 11	5,5 - 8,5	21	21	10
A1100.11.120	Pg 11	8,5 - 12,0	21	21	10
A1100.13.080	Pg 13	6,0 - 8,0	24	21	10
A1100.13.110	Pg 13	8,0 - 11,0	24	21	10
A1100.13.150	Pg 13	11,0 - 15,0	24	23	10
A1100.16.080	Pg 16	6,0 - 8,0	24	23	10
A1100.16.110	Pg 16	8,0 - 11,0	24	23	10
A1100.16.150	Pg 16	11,0 - 15,0	24	23	10
A1100.21.125	Pg 21	9,5 - 12,5	30	28	12
A1100.21.160	Pg 21	12,5 - 16,0	30	28	12
A1100.21.205	Pg 21	16,0 - 20,5	30	28	12
A1100.29.190	Pg 29	16,0 - 19,0	38	28	12
A1100.29.230	Pg 29	19,0 - 23,0	38	28	12
A1100.29.275	Pg 29	23,0 - 27,5	38	28	12
A1100.36.260	Pg 36	21,5 - 26,0	50	32	15
A1100.36.305	Pg 36	26,0 - 30,5	50	32	15
A1100.36.350	Pg 36	30,5 - 35,0	50	32	15
A1100.42.330	Pg 42	29,0 - 33,0	50	34	15
A1100.42.370	Pg 42	33,0 - 37,0	55	34	15
A1100.42.420	Pg 42	37,0 - 42,0	55	34	15
A1100.48.370	Pg 48	32,0 - 37,0	65	37	15
A1100.48.430	Pg 48	37,0 - 43,0	65	37	15
A1100.48.490	Pg 48	43,0 - 49,0	65	37	15

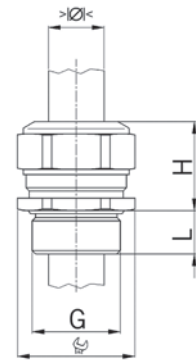

**Joint court en deux parties**

A1100.09	Pg 9	6,0 - 10,5	18	22	10
A1100.11	Pg 11	5,5 - 12,0	21	21	10
A1100.13	Pg 13	8,0 - 15,0	24	23	10
A1100.16	Pg 16	8,0 - 15,0	24	23	10
A1100.21	Pg 21	12,5 - 20,5	30	28	12
A1100.29	Pg 29	19,0 - 27,5	38	28	12
A1100.36	Pg 36	26,0 - 35,0	50	32	15
A1100.42	Pg 42	33,0 - 42,0	55	34	15
A1100.48	Pg 48	37,0 - 49,0	65	37	15