

M3.5



ERC

Feed-through terminal, Screw connection, Mounting type: Mounting rail TS 35/7.5, Rated cross-section: 10 mm², Width: 8 mm, Colour: Beige

Business data

Packaging unit	80
Quantity unit	PC
Weight per piece (not including packaging)	13.4 g
Weight per piece (including packaging)	14.26 g
Unit of weight	G
Customs number	85369010
Country of origin	DE
Product description	Feed-through terminal

Technical data

Dimensions

Length	62.5 mm
Width	8 mm
Height TS 35/7.5	47 mm

Ratings

Rated voltage	320 V
Rated current	41 A
Current load, max.	57 A
Rated cross-section	10 mm ²
Rated impulse voltage	8 kV
Overvoltage category	III
Contamination degree	3
Maximum power dissipation for nominal condition	1.31 W

Technical data

Connection data

Connection principle	Screw connection
Connection position	Lateral
Connections	4
Special connection	Spade flat plug Faston 2.8 mm
Number of terminals per level	2
Number of levels	1
Wire cross-section single-core (rigid) / stranded, min.	0.2 mm ²
Wire cross-section single core (rigid)/stranded, max.	10 mm ²
Wire cross-section stranded, min.	0.2 mm ²
Wire cross-section stranded, max.	10 mm ²
Wire cross-section stranded with wire-end ferrules, min.	0.2 mm ²
Wire cross-section stranded with wire-end ferrules, max.	6 mm ²
Wire cross-section AWG, min.	22
Wire cross-section AWG, max.	8
Stripping length	10 mm
Screw head	Slotted
Screw threading	M 3,5
Tightening torque, min.	1.2 Nm
Tightening torque, max.	2 Nm

Materials

Insulation housing	Polyamide 6.6
Flammability class UL 94	V-0
Working temperature, min.	-40 °C
Working temperature, max.	120 °C

Technical data

Further technical data

Mounting type	Mounting rail TS 35/7,5
Gauge plug acc. to EN 60 947-1	A5
Number of cross-connection channels	2
End plate required	✓
Number of test pick-off options	1

Print

Colour	Beige
--------	-------

Environmental Product Compliance

REACH Conform	yes
REACH Reference date	2021-07-08
REACH Candidate Substance Note	No
RoHS Conform	yes

Approvals

Standards and regulations

EAC approval	TR ZU 004/2011
EAC approval granted	yes

German Lloyd approval

GL approval	IEC 60947-7-1:2009
GL approval granted	yes
GL rated voltage	1000 V
GL rated current	57 A
GL rated cross-section	6 mm ²
GL rated impulse voltage	8 kV
GL environmental category	C

Media

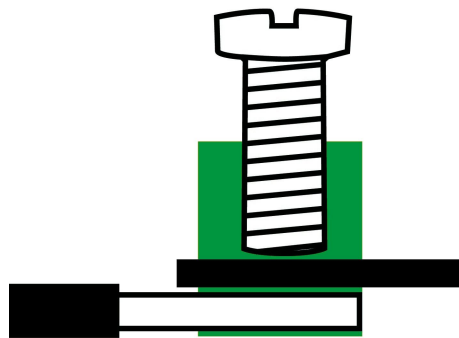
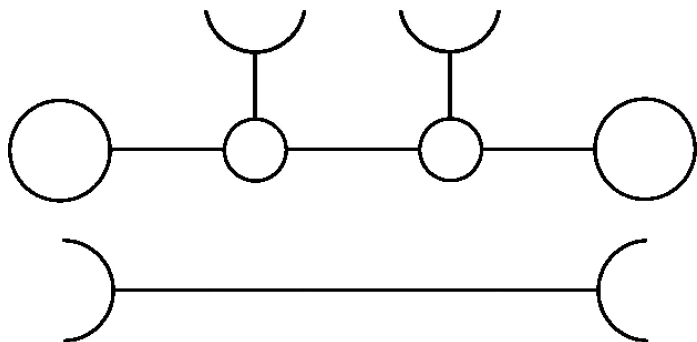

M3.5

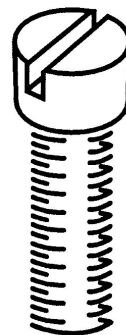

EAC

17117.2

SRK 6/2A SAS BG

Accessories

Cover

Cover, Width: 8 mm, Colour: Yellow



detail.dataSheet.generalOrderData

Product number:	detail.dataSheet.productName	GTIN (EAN)	detail.dataSheet.
17297.8	SAD 1/8/B YE	4044211205454	500 ST

Measurement pick-off terminal



Measurement pick-off terminal, Screw connection, Mounting type: On base, Rated cross-section: 4 mm², Width: 6.6 mm, Colour: Beige

detail.dataSheet.generalOrderData

Product number:	detail.dataSheet.productName	GTIN (EAN)	detail.dataSheet.
17121.2	SMAG 6/4 BG	4044211172114	500 ST

17117.2

SRK 6/2A SAS BG

Accessories

End plate

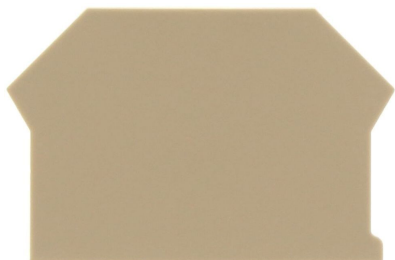

End plate, Width: 1.5 mm, Colour: Beige

detail.dataSheet.generalOrderData

Product number:	detail.dataSheet.productName	GTIN (EAN)	detail.dataSheet.
2001.2	AP 2,5-10 BG	4044211047979	500 ST

End stop

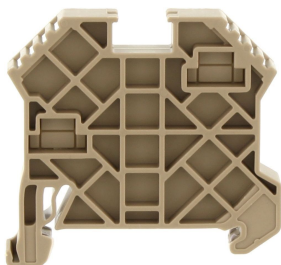

End stop, Mounting type: Mounting rail TS 35/7.5 and TS 35/15, Width: 8 mm, Colour: Beige

detail.dataSheet.generalOrderData

Product number:	detail.dataSheet.productName	GTIN (EAN)	detail.dataSheet.
17250.2	SES 35 BG	4044211178253	500 ST

17117.2

SRK 6/2A SAS BG

Accessories

Insulation cap for cross-connector



Insulating cap, Colour: Yellow

detail.dataSheet.generalOrderData

Product number:	detail.dataSheet.productName	GTIN (EAN)	detail.dataSheet.
17200.8	SQIK 2,5-10 YE	4044211148539	500 ST

Accessories

Insulated cross-connector



Insulated cross-connector, No. of poles: 7,
Mounting type: Plug in, Width: 54.8 mm,
Rated cross-section: 6 mm², Colour: Yellow

detail.dataSheet.generalOrderData

Product number:	detail.dataSheet.productName	GTIN (EAN)	detail.dataSheet
17226.8	SQI 6/7 YE	4044211148799	500 ST



Insulated cross-connector, No. of poles: 8,
Mounting type: Plug in, Width: 62.9 mm,
Rated cross-section: 6 mm², Colour: Yellow

detail.dataSheet.generalOrderData

Product number:	detail.dataSheet.productName	GTIN (EAN)	detail.dataSheet
17227.8	SQI 6/8 YE	4044211148805	500 ST



Insulated cross-connector, No. of poles: 4,
Mounting type: Plug in, Width: 30.5 mm,
Rated cross-section: 6 mm², Colour: Yellow

detail.dataSheet.generalOrderData

Product number:	detail.dataSheet.productName	GTIN (EAN)	detail.dataSheet
17223.8	SQI 6/4 YE	4044211148768	500 ST

17117.2

SRK 6/2A SAS BG

Accessories

Insulated cross-connector



Insulated cross-connector, No. of poles: 9,
Mounting type: Plug in, Width: 71 mm, Rated
cross-section: 6 mm², Colour: Yellow

detail.dataSheet.generalOrderData

Product number:	detail.dataSheet.productName	GTIN (EAN)	detail.dataSheet.
17228.8	SQI 6/9 YE	4044211148812	500 ST



Insulated cross-connector, No. of poles: 10,
Mounting type: Plug in, Width: 79.1 mm,
Rated cross-section: 6 mm², Colour: Yellow

detail.dataSheet.generalOrderData

Product number:	detail.dataSheet.productName	GTIN (EAN)	detail.dataSheet.
17229.8	SQI 6/10 YE	4044211148829	500 ST



Insulated cross-connector, No. of poles: 2,
Mounting type: Plug in, Width: 14.3 mm,
Rated cross-section: 6 mm², Colour: Yellow

detail.dataSheet.generalOrderData

Product number:	detail.dataSheet.productName	GTIN (EAN)	detail.dataSheet.
17221.8	SQI 6/2 YE	4044211148744	500 ST

17117.2

SRK 6/2A SAS BG

Accessories

Insulated cross-connector



Insulated cross-connector, No. of poles: 3,
Mounting type: Plug in, Width: 22.4 mm,
Rated cross-section: 6 mm², Colour: Yellow

detail.dataSheet.generalOrderData

Product number:	detail.dataSheet.productName	GTIN (EAN)	detail.dataSheet.
17222.8	SQI 6/3 YE	4044211148751	500 ST



Insulated cross-connector, No. of poles: 6,
Mounting type: Plug in, Width: 46.7 mm,
Rated cross-section: 6 mm², Colour: Yellow

detail.dataSheet.generalOrderData

Product number:	detail.dataSheet.productName	GTIN (EAN)	detail.dataSheet.
17225.8	SQI 6/6 YE	4044211148782	500 ST



Insulated cross-connector, No. of poles: 30,
Mounting type: Plug in, Width: 240 mm,
Rated cross-section: 6 mm², Colour: Yellow

detail.dataSheet.generalOrderData

Product number:	detail.dataSheet.productName	GTIN (EAN)	detail.dataSheet.
17230.8	SQI 6/30 YE	4044211148836	500 ST

17117.2

SRK 6/2A SAS BG

Accessories

Insulated cross-connector



Insulated cross-connector, No. of poles: 5,
Mounting type: Plug in, Width: 38.6 mm,
Rated cross-section: 6 mm², Colour: Yellow

detail.dataSheet.generalOrderData

Product number:	detail.dataSheet.productName	GTIN (EAN)	detail.dataSheet.
17224.8	SQI 6/5 YE	4044211148775	500 ST

Quick marking

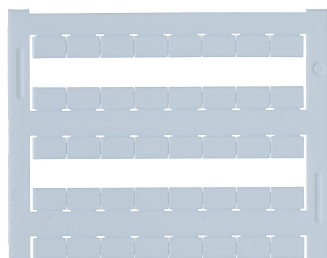

Terminal marker / Pocket Maxicard, Length: 5 mm,
Width: 8 mm, Colour: White

detail.dataSheet.generalOrderData

Product number:	detail.dataSheet.productName	GTIN (EAN)	detail.dataSheet.
9323.7	PMC SB 8/40 WH	4044211129231	500 ST

Accessories

Screwdriver



Screwdriver with bare blade, Colour: Black-grey

detail.dataSheet.generalOrderData

Product number:	detail.dataSheet.productName	GTIN (EAN)	detail.dataSheet.
1087.0	SDB 0,8x4,0	4044211014803	500 ST

Partition plate



Partition plate, Width: 1.5 mm, Colour: Beige

detail.dataSheet.generalOrderData

Product number:	detail.dataSheet.productName	GTIN (EAN)	detail.dataSheet.
2002.2	TW 2,5-10 BG	4044211048044	500 ST

17117.2

SRK 6/2A SAS BG

Accessories

Test adapters

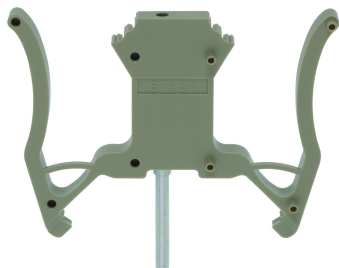

Test adapter, Length: 70 mm, Pitch size: 5 mm, Colour: Beige

detail.dataSheet.generalOrderData

Product number:	detail.dataSheet.productName	GTIN (EAN)	detail.dataSheet.
17260.2	STA 5/1 BG	4044211171599	500 ST



Test adapter, Length: 70 mm, Pitch size: 3 mm, Colour: Beige

detail.dataSheet.generalOrderData

Product number:	detail.dataSheet.productName	GTIN (EAN)	detail.dataSheet.
17262.2	STA ZP3 BG	4044211171612	500 ST