



KTS-2012UV395 2.0 x 1.25 mm UV LED With Ceramic Substrate

FEATURES

- 2.0 mm x 1.25 mm SMD LED, 0.75 mm thickness
- Low power consumption
- Wide viewing angle
- Package: 2000 pcs / reel
- Moisture sensitivity level: 1
- RoHS compliant

APPLICATIONS

- Photocatalytic Purification
- Blood and Counterfeit money detection
- UV curing in nail salon, dental, and poster printing applications
- UV Sensor Light

PACKAGE MATERIALS

- Material as follows:
Package: Ceramics
Encapsulating resin: Silicone resin
Electrodes: Au plating

ATTENTION

Observe precautions for handling electrostatic discharge sensitive devices



PACKAGE DIMENSIONS

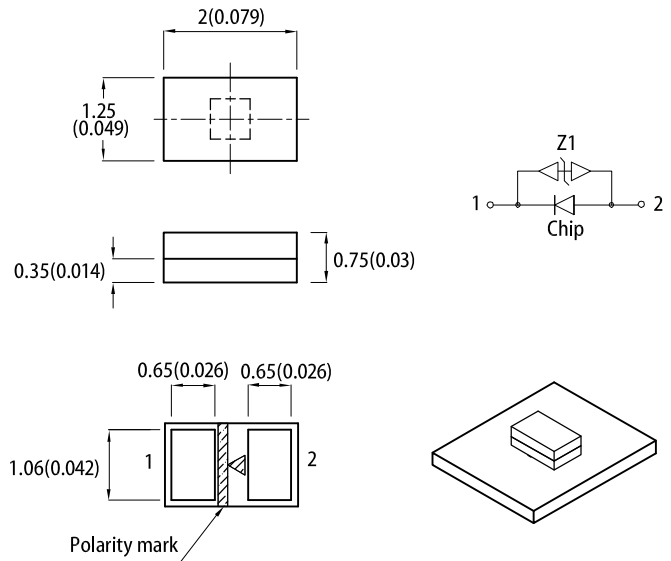

RECOMMENDED SOLDERING PATTERN

(units : mm; tolerance : ± 0.1)

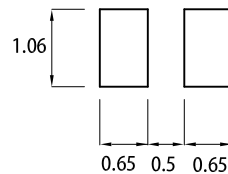

Notes:

1. All dimensions are in millimeters (inches).
2. Tolerance is $\pm 0.25(0.01)$ unless otherwise noted.
3. The specifications, characteristics and technical data described in the datasheet are subject to change without prior notice.
4. The device has a single mounting surface. The device must be mounted according to the specifications.

SELECTION GUIDE

Part Number	Emitting Color (Material)	Lens Type	$\Phi_e(\text{mW})$ ^[2] @ 20mA		Viewing Angle ^[1]
			Min.	Typ.	2 θ 1/2
KTS-2012UV395	Ultraviolet (InGaN)	Water Clear	10	16	150°

Notes:
1. θ 1/2 is the angle from optical centerline where the radiant intensity is 1/2 of the optical peak value.
2. Radiant flux: +/-15%.
3. Radiant flux value is traceable to CIE127-2007 standards.

ELECTRICAL / OPTICAL CHARACTERISTICS at $T_A=25^\circ\text{C}$

Parameter	Symbol	Value	Unit
Wavelength at Peak Emission $I_F = 20\text{mA}$ [Min.]	λ_{peak}	390	nm
Wavelength at Peak Emission $I_F = 20\text{mA}$ [Typ.]		395	
Wavelength at Peak Emission $I_F = 20\text{mA}$ [Max.]		400	
Spectral Bandwidth at 50% Φ REL MAX $I_F = 20\text{mA}$ [Typ.]	$\Delta\lambda$	13	nm
Forward Voltage $I_F = 20\text{mA}$ [Typ.]	$V_F^{[1]}$	3.3	V
Forward Voltage $I_F = 20\text{mA}$ [Max.]		3.8	
Reverse Current ($V_R = 5\text{V}$) [Max.]	I_R	50	μA
Temperature Coefficient of V_F $I_F = 20\text{mA}$, $-10^\circ\text{C} \leq T \leq 85^\circ\text{C}$	TC_V	-3.0	$\text{mV}/^\circ\text{C}$

Notes:

1. Forward voltage: $\pm 0.1\text{V}$.
2. Wavelength value is traceable to CIE127-2007 standards.
3. Excess driving current and / or operating temperature higher than recommended conditions may result in severe light degradation or premature failure.

ABSOLUTE MAXIMUM RATINGS at $T_A=25^\circ\text{C}$

Parameter	Symbol	Value	Unit
Power Dissipation	P_D	120	mW
Reverse Voltage	V_R	5	V
Junction Temperature	T_j	115	$^\circ\text{C}$
Operating Temperature	T_{op}	-40 to +85	$^\circ\text{C}$
Storage Temperature	T_{stg}	-40 to +85	$^\circ\text{C}$
DC Forward Current	I_F	30	mA
Peak Forward Current	$I_{\text{FM}}^{[1]}$	100	mA
Thermal Resistance (Junction / Ambient)	$R_{\text{th JA}}^{[2]}$	100	$^\circ\text{C}/\text{W}$
Thermal Resistance (Junction / Solder point)	$R_{\text{th JS}}^{[2]}$	50	$^\circ\text{C}/\text{W}$

Notes:

1. 1/10 Duty Cycle, 0.1ms Pulse Width.
2. $R_{\text{th JA}}$, $R_{\text{th JS}}$ Results from mounting on PC board FR4 (pad size $\geq 16\text{mm}^2$ per pad).
3. Relative humidity levels maintained between 40% and 60% in production area are recommended to avoid the build-up of static electricity – Ref JEDEC/JESD625-A and JEDEC/J-STD-033.

TECHNICAL DATA

RELATIVE INTENSITY vs. WAVELENGTH

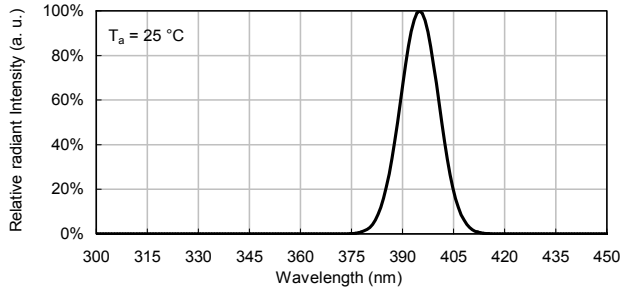

SPATIAL DISTRIBUTION

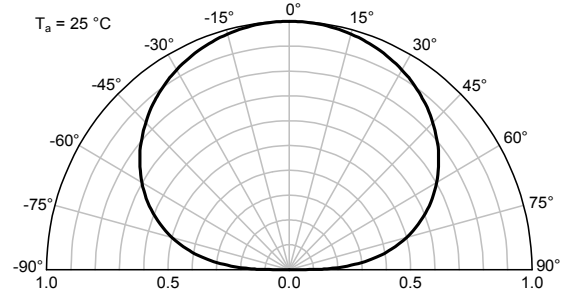

ULTRAVIOLET

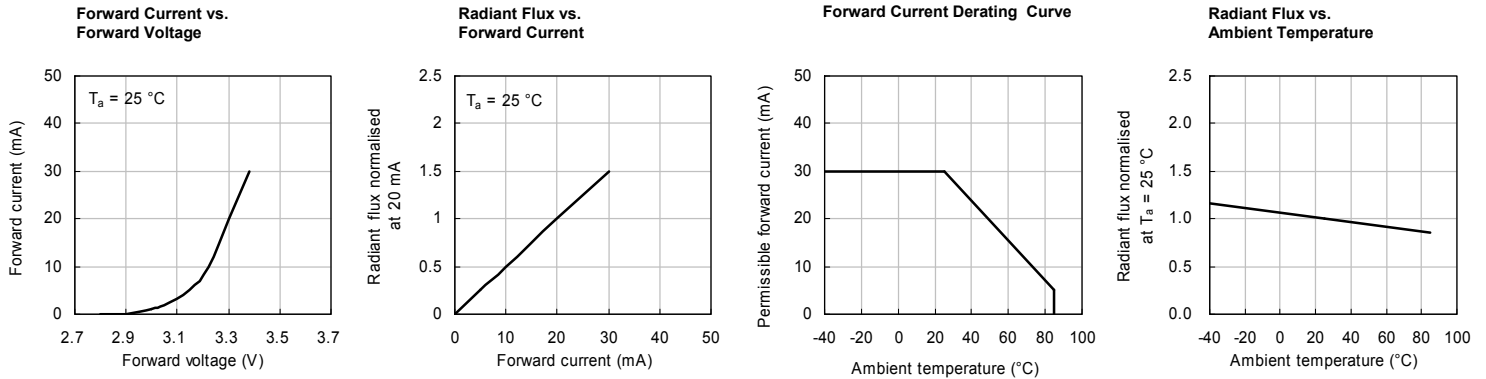

REFLOW SOLDERING PROFILE for LEAD-FREE SMD PROCESS

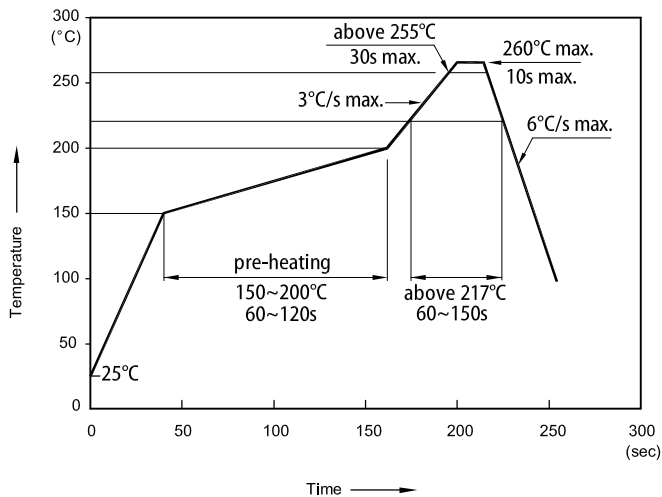

TAPE SPECIFICATIONS (units : mm)

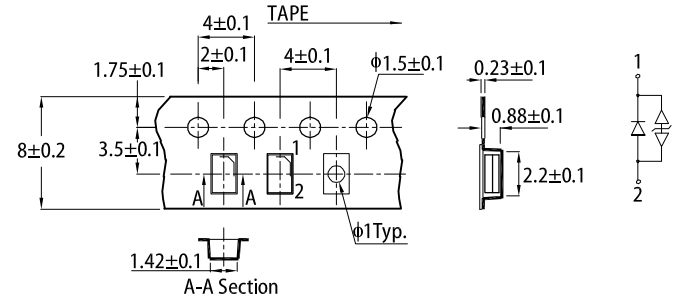

REEL DIMENSION (units : mm)

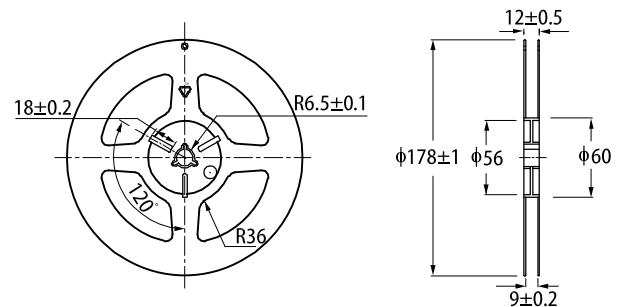

- Notes:
1. Don't cause stress to the LEDs while it is exposed to high temperature.
 2. The maximum number of reflow soldering passes is 2 times.
 3. Reflow soldering is recommended. Other soldering methods are not recommended as they might cause damage to the product.

PACKING & LABEL SPECIFICATIONS

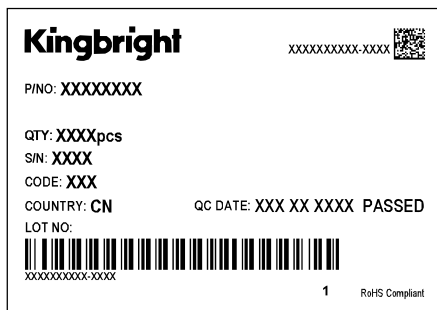
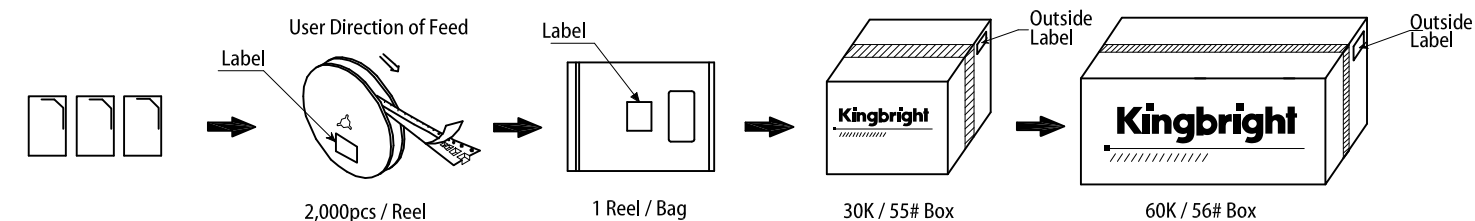

HANDLING PRECAUTIONS

Compare to epoxy encapsulant that is hard and brittle, silicone is softer and flexible. Although its characteristic significantly reduces thermal stress, it is more susceptible to damage by external mechanical force. As a result, special handling precautions need to be observed during assembly using silicone encapsulated LED products. Failure to comply might lead to damage and premature failure of the LED.

1. Handle the component along the side surfaces by using forceps or appropriate tools.
2. Do not directly touch or handle the silicone lens surface. It may damage the internal circuitry.
3. Do not stack together assembled PCBs containing exposed LEDs. Impact may scratch the silicone lens

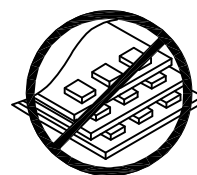
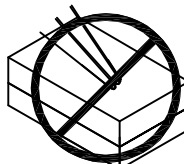
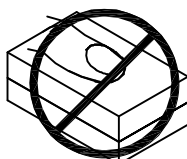
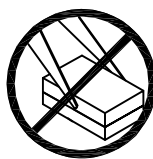
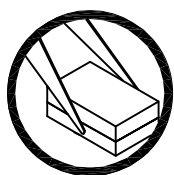

4. As silicone encapsulation is permeable to gases, some corrosive substances such as H₂S might corrode silver plating of lead frame. Special care should be taken if an LED with silicone encapsulation is to be used near such substances.

PRECAUTIONARY NOTES

1. The information included in this document reflects representative usage scenarios and is intended for technical reference only.
2. The part number, type, and specifications mentioned in this document are subject to future change and improvement without notice. Before production usage customer should refer to the latest datasheet for the updated specifications.
3. When using the products referenced in this document, please make sure the product is being operated within the environmental and electrical limits specified in the datasheet. If customer usage exceeds the specified limits, Kingbright will not be responsible for any subsequent issues.
4. The information in this document applies to typical usage in consumer electronics applications. If customer's application has special reliability requirements or have life-threatening liabilities, such as automotive or medical usage, please consult with Kingbright representative for further assistance.
5. The contents and information of this document may not be reproduced or re-transmitted without permission by Kingbright.
6. All design applications should refer to Kingbright application notes available at http://www.Kingbright.com/application_notes