

C4BS, Film, Metallized Polypropylene, Power, 0.68 uF, 5%, 600 VAC, 1000 VDC, 70°C, Lead Spacing = 25mm

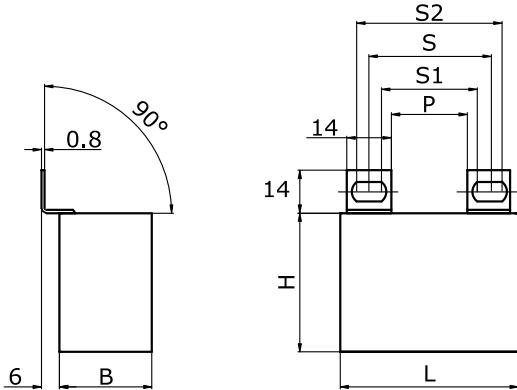

Dimensions	
L	41.5mm NOM
H	40mm NOM
T	20mm NOM
S	25mm +/-0.2mm
S1	21.5mm +/-0.2mm
P	10.5mm NOM

Packaging Specifications	
Packaging:	Bulk, Bag
Packaging Quantity:	52

General Information	
Supplier:	KEMET
Series:	C4BS
Dielectric:	Metallized Polypropylene
Style:	Radial
Features:	IGBT Circuit
RoHS:	Yes
Lead:	Flat Tabs
Miscellaneous:	KEMET Style A Tabs

Specifications	
Capacitance:	0.68 uF
Capacitance Tolerance:	5%
Voltage AC:	600 VAC
Voltage DC:	1000 VDC
Temperature Range:	-40/+85C
Rated Temperature:	70°C
Max dV/dt:	827 V/us
Resistance:	5.3 mOhms (100kHz)
Ripple Current:	20 Amps (100kHz 70C), 563 Amps (Peak)
Inductance:	41 nH

Statements of suitability for certain applications are based on our knowledge of typical operating conditions for such applications, but are not intended to constitute - and we specifically disclaim - any warranty concerning suitability for a specific customer application or use. This Information is intended for use only by customers who have the requisite experience and capability to determine the correct products for their application. Any technical advice inferred from this Information or otherwise provided by us with reference to the use of our products is given gratis, and we assume no obligation or liability for the advice given or results obtained.