

order number: L00000A0203

Patch Cord Cat.6<sub>A</sub> MP8 FS 500 LSZH-0,5 m; 1x90° cable boot; white

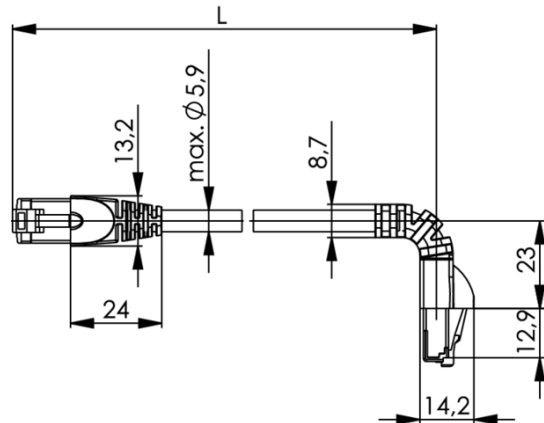

Technical Attributes	
Short name	MP8 FS 500 LSZH-0,5
Length	0,5 m
Colour	white
Remarks	1x90° - 1x180° cable boot

### Performance Characteristics

- pin assignment acc. to EIA/TIA 568B
- 90° / 180° / 270° moulded boot with latch protection
- Colours: grey, green, red, blue, yellow, black, white, purple
- Variants with very short boot
- 360 degrees completely surround plug shielding (shielded cable types)
- flexible and strain relieved
- moulded strain relief boot
- cable jacket and strain relief boot: PVC resp. LSZH (= Low Smoke, Zero Halogen)

Mechanical Characteristics	
Cable structure	LI02YSCH 4x2xAWG 27/7 PiMF
Stranded wire	AWG 27 (7/0.14 mm)

Insulation	PE, Ø 1.02 mm (±0.05 mm)
Pair shielding	Al-foil, outside conducting
Overall shielding	tin plated copper braid
Outer jacket	5.8 mm (±0.2 mm)

Climatic Characteristics	
flame-retardant test	IEC 60332-1
UL	E244889
Operating temperature in °C	-40°C to 75°C

Electrical Characteristics	
Current carrying capacity at 50°C	1 A
PoE+ acc to IEEE 802.3at	Adequate for Power over Ethernet+

Standards	
Connectors	IEC 60603-7-51

Transmission Characteristics	
10 Gigabit Ethernet acc. to IEEE 802.3an	Adequate for 10 Gigabit Ethernet
Gigabit Ethernet acc. to IEEE 802.3	