



Limitless™ Wireless  
Hazardous Area Limit Switches  
**WBX Series**



Datasheet

# Limitless™ WBX Series

## Wireless Hazardous Area Limit Switch

Honeywell's Limitless™ WBX Series combines the best of Honeywell's MICRO SWITCH™ Heavy Duty limit switches with a point-to-point (P2P) network. It has a variety of remote or built-in antenna options. Wireless-enabled limit switches can be used for position sensing and presence/absence detection for an endless number of applications.

The WBX Series is especially beneficial for remote monitoring applications where wiring or wire maintenance is not physically possible or economically feasible. Combining this greater flexibility with proven harsh-duty packaging can result in increased efficiencies and improved safety for machines, equipment, and operators.

Customers with a global footprint can utilize local Honeywell experts for application and solution support.

### *What makes our switches better?*

- Enables control in remote parts of application/machinery/manufacturing plants, where wiring is not possible or feasible
- Ability to reconfigure and network multiple interfaces, or point-to-point with personalized addresses which allows for adding, subtracting, or relocating Limitless™ inputs easily
- Can reduce installation/maintenance costs with no wiring to Limitless™ switches, conduit, strain relief, clips, connectors, junction boxes, etc.
- Wireless operation and signal transmission eliminates the need to physically send maintenance engineers into the field thus reducing installation and operating costs
- Provides an independent layer of protection for equipment, by giving an immediate indication that a remote mechanical device is not positioned or moving correctly
- Batteries are inexpensive, readily available worldwide, and easy to replace. No re-provisioning is required after a battery replacement
- Batteries are readily available and easy to replace



REMOTE MONITORING • RELIABLE  
GLOBAL APPLICATION AND ENGINEERING SUPPORT

# Features and Benefits

## WIRELESS DESIGN

Radio (license-free and global) WPAN 802.15.4, 2.4 GHz, point-to-point (P2P) provides **reliable, flexible, and secure wireless transmission**. Up to **305 m [1000 ft] line-of-sight communication** range when used with a Limitless™ WPMM Series wireless monitor, WDRR Series receiver module, or WMPR receiver module (sold separately).

The use of AES 128 bit encryption ensures that no unregistered node can successfully insert erroneous signals into a network or decode signals from a network, making the network secure from both eavesdropping and sabotage.

*Ability to install in applications where not previously possible*

## REMOTE CONTROL AND MONITORING

**License-free RF wireless protocol** standards (IEEE 802.15.4) allow for remote control and monitoring of processes and equipment.

## WIRELESS SWITCHING IN CLASSIFIED ATMOSPHERES

Designed to be used where other wireless products can not. Hazardous location approvals allow it to be **used in a wide range of classified atmospheres**, allowing for greater flexibility, making the Limitless™ WBX product application adaptable.

*A cost-effective solution*

## WELL-SUITED FOR TOUGH ENVIRONMENTS

IP67 (self certified), NEMA 4 sealed metal enclosure, with direct or remote mount antenna options, allows **for use in most harsh environments**. Powder-coated aluminum housing **enhances durability** and **resistance to corrosion**.

## RECONFIGURABLE

Able to reconfigure multiple WBX Series switches **easily allows for adding, subtracting, or relocating** of Limitless™ WBX Series switches. Eliminates issues with wire connection integrity on moving equipment.

## REDUCES COSTS

**Can reduce installation and maintenance costs** because there are no wires, conduit, strain relief, clips, connectors, connection boxes, etc.

## OFF-THE-SHELF BATTERIES

**Batteries** are available from electrical supply houses and distributors. They are readily available worldwide, thereby eliminating the need for specialized batteries.

## GLOBAL USE

Designed for **global availability**, the WBX Series is suitable for use in most customer applications, simplifying the design-in process, eliminating tooling costs, and reducing manufacturing labor costs.

# Potential Applications



## INDUSTRIAL

- Agriculture machines
- Door position
- Grain diverters or flaps
- Hose attachment verification
- Material handling
- Paint robotics
- Pipeline pigs
- Pump stroke count
- Remote or temporary equipment
- Safety shower alarming
- Valve position

## TRANSPORTATION

- Agricultural equipment

## PRODUCT NOMENCLATURE

WBX	1	A	00	A	A	A	1A	3
Switch type	Gen Code	RF Code	Antenna type code	Country use code	Zone use code	Operating head code	Actuator code	Modification code
<b>WBX Series Wireless</b>	<b>1</b> Version 1	<b>A</b> 2.4 GHz; IEEE 802.15.4	<b>00</b> No antenna; RP-SMA connector jack	<b>A</b> US, Canada, Australia	<b>A</b> Zone 0, Zone 20	<b>A</b> Side rotary, momentary	<b>1</b> Fixed, rollerless 1.5 in radius	Head assembled with actuator to nameplate side
		For "B" coded versions, refer to WBX ISA100 datasheet, 50095584.	<b>12</b> 2.0 dBi omni w/switch mount; straight design with radome	<b>B</b> All approved countries	<b>B</b> Zone 1, Zone 21	<b>C</b> Top plunger, plain	<b>1A</b> Fixed 0.75 in x 0.25 in nylon roller, front mount	<b>3</b> Head assembled with actuator to right side
			<b>14</b> 2.0 dBi omni w/switch mount; 90° metal elbow with radome		Refer to Zone Use Classification.	<b>J</b> Wobble stick	<b>1C</b> Fixed 0.75 in x 0.25 in nylon roller, back mount	<b>4</b> Head assembled with actuator to left side
							<b>2</b> Adjustable, rollerless	<b>5</b> Head assembled with actuator to mounting surface
							<b>2A</b> Adjust. 0.75 in x 0.25 in nylon roller, back mount	
							<b>2C</b> Adjust. 0.75 in x 0.25 in nylon roller, front mount	
							<b>2J</b> Adjust. 1 in x 0.5 in nylon roller, front mount	
							<b>2K</b> Adjust. 1.5 in x 0.25 in nylon roller, front mount	
							<b>3E</b> Yoke, 0.75 in x 0.25 in nylon roller, back/front	
							<b>3M</b> Yoke, 0.75 in x 1.25 in nylon roller, back/front	
							<b>3S</b> Yoke, 0.75 in x 0.25 in nylon roller, back/back	
							<b>04</b> Hub only	
							<b>4M</b> Hub rod, 5.5 in, aluminum	
							<b>5</b> Offset, rollerless	
							<b>5A</b> Offset, 0.75 in x 0.25 in nylon roller, back mount	
							<b>5C</b> Offset, 0.75 in x 0.25 in nylon roller, front mount	
							<b>7A</b> Delrin™ rod, 5.5 inches*	
							<b>9A</b> Short fixed, 0.75 x 0.25 in nylon roller, front mount	
							<b>9C</b> Short fixed, 0.75 x 0.25 in nylon roller, back mount	

### Zone Use Classifications

Zones refer to classified atmosphere ratings. Single digit indicators (Zone 0 or 1) refer to degree of protection from explosive gases. Double digit indicators (Zone 20 or 21) refer to degree of protection from explosive dusts.

**Zone 0:** An area in which an explosive gas is present continuously or for long periods.

**Zone 20:** An area in which an explosive dust is present continuously or for long periods.

**Zone 1:** An area in which an explosive gas is likely to occur in normal operation.

**Zone 21:** An area in which an explosive dust is likely to occur in normal operation.

\* 7A to be assembled to operating head code J only.

# Limitless™ Wireless Hazardous Area Limit Switches

**Table 1. Specifications**

Characteristic	Parameter
Series name	WBX Series
Product type	Limitless™ Hazardous Area Limit Switches
Availability	global, license-free bands
Actuator	side rotary, top plunger, wobble stick
Lever type	many rotary lever options available
Housing material	powder-coated die-cast aluminum body
Radio/communication protocol	IEEE 802.15.4, 2.4 GHz radio; WPAN 802.15.4
Data rate	250 kbps
Operating frequency	ISM 2.4 GHz
Module transmit power	country use code A: 14 dBm max. country use code B: 8 dBm max.
Receive sensitivity (typ.)	-98 dBm
Periodic update interval (seconds)	field programmable interval: 1, 5, 10, 30, or 60 second intervals
Antenna type	direct or remote mount antenna options; omni directional; straight or elbow
Signal range (max.)*	nominal 305 m [1000 ft] clear line of sight between the WBX switch and monitor/receiver when using 2.0 dBi integral antenna
Battery	3.6 Vdc Lithium Thionyl Chloride; AA size, quantity: 2; see battery details on page 6.
Battery life	one year at five-second update interval @ 25 °C [77 °F]
Sealing	NEMA 1, 3, 4, 13; IP67 (self-certified)
EMC	latest applicable standards: EN 300 328, V1.8.1; EN 61326-1 (2012); EN 301 489-1, V1.9.2; EN 301 489-17, V2.2.1
Shock	IEC 60068-2-27; half sine, 50 g, 6 mS
Vibration	IEC 60068-2-6: 10 Hz to 58 Hz w/0,35 mm peak-to-peak, 58 Hz to 500 Hz, 10 g
Operating temperature	-40 °C to 70 °C [-40 °F to 158 °F]
Communication agency approvals and standards	FCC 15.247 and 15.209 Industry Canada RSS 210 Gen Issue 8 ETSI, CE mark, ACMA, C-tick mark
cULus standards and certifications	Standards: UL913 8th edition; CAN/CSA-C22.2 No. 157-92 (R2012) UL 60079-0 edition 6; UL 60079-11 edition 6 CSA C22.2 No. 60079-11 : 14 edition 2; CSA C22.2 No. 60079-0 : 11 edition 2
	Class I, Div 1, Groups A, B, C, D T4 Class I, Zone 1 AEx ia IIC T4 Ga Class I, Zone 1 Ex ia IIC T4 Ga Class II, Zone 21 AEx ia IIIC T135°C Da Class II, Div 1, Groups E, F, G Class I, Zone 0 AEx ia IIC T4 Ga Class I, Zone 0 Ex ia IIC T4 Ga Class II, Zone 20 AEx ia IIIC T135°C Da Tambient -40°C to 70°C
ATEX certification	Standards: EN 60079-0 : 2012+ A11 : 2013 EN 60079-11 : 2012; EN 60079-26 : 2007
	Zone 1 Ex ia IIC T4 Ga Zone 21 Ex ia IIIC T135°C Da Zone 0 Ex ia IIC T4 Ga Zone 20 Ex ia IIIC T135°C Da
IEC Ex certification	Standards: IEC 60079-0 edition 6.0; IEC 60079-11 edition 6.0; IEC 60079-26 edition 2.0
	Zone 1 Ex ia IIC T4 Ga Zone 21 Ex ia IIIC T135°C Da Zone 0 Ex ia IIC T4 Ga Zone 20 Ex ia IIIC T135°C Da

\* Actual range will vary depending upon antennas, cables, and site topography.

# WBX Series: Point-to-Point Network

Table 2. Battery Specifications\*

Characteristic	Technical Data (typical values @ 25 °C for batteries stored)
Honeywell battery part number	WBT7
Battery size (each cell)	AA Ø 14,5 mm x 50,5 mm L [Ø 0.57 in x 1.99 in L]
Battery type	Lithium Thionyl Chloride
Nominal capacity @ 2 mA, up to 2 V	2.4 Ah
Rated voltage	3.6 V
Max. recommended continuous current	200 mA
Max. pulse current capability	400 mA
Weight	17.6 g [0.62 oz] per cell
Lithium metal content	0.7 g per cell (approx.)
Volume	8 cc per cell
Operating temperature	-55 °C to 85 °C [-67 °F to 185 °F]
Storage temperature (recommended)	30 °C [86 °F]
Suggested alternate sources of battery cell supply	Xeno Energy (part number XL-060F) Bipower (part number ER14505H) Tadiran (part number TL-5903/S)

## EXAMPLE POINT-TO-POINT SYSTEM DIAGRAM

Figure 1. WBX Limitless™ Point-to-Point System Diagram

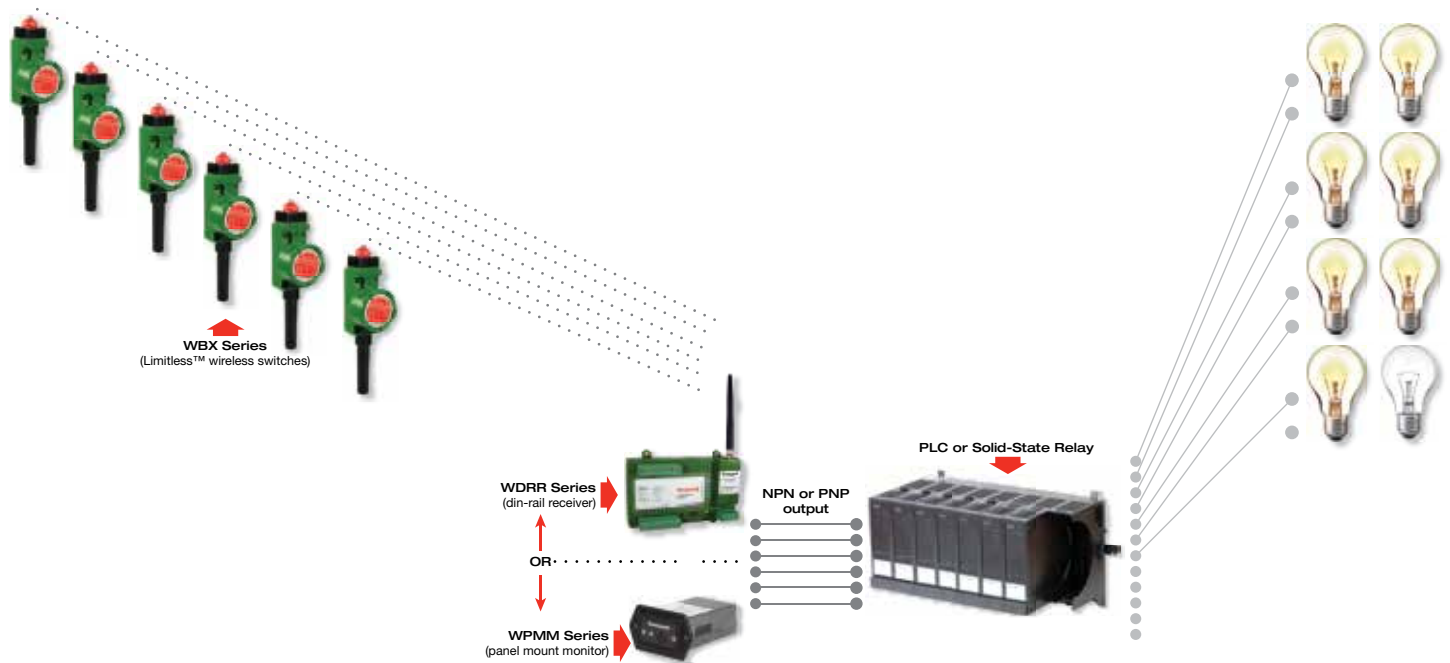

# Limitless™ Wireless Hazardous Area Limit Switches

## MOUNTING AND REFERENCE DIMENSIONS

Figure 2. Limitless™ WBX Series Side Rotary Dimensions

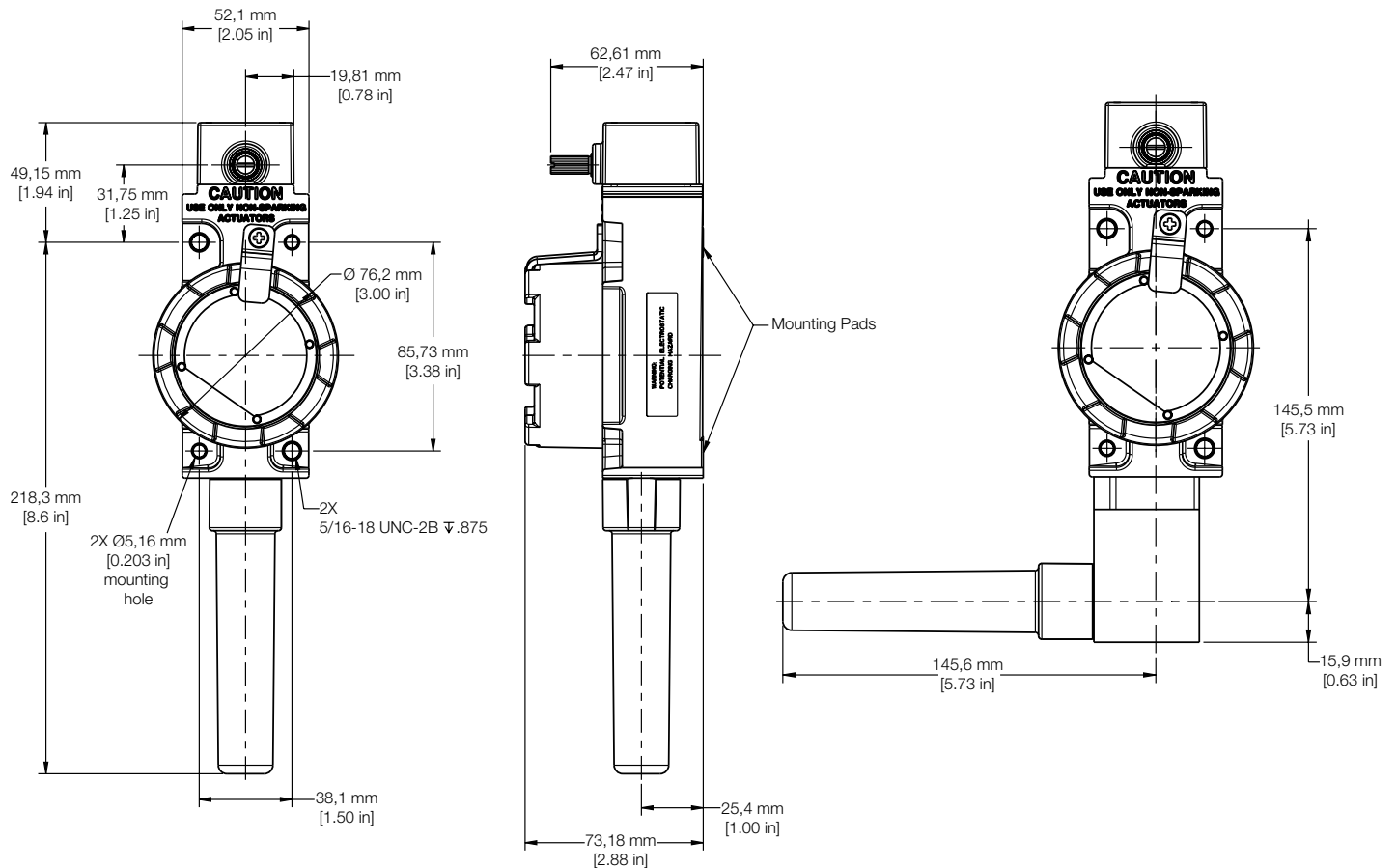

**Operating Head Code "A"  
Straight Antenna**

**Operating Head Code "A"  
90° Antenna**

## MECHANICAL OPERATING SPECIFICATIONS

for Side Rotary Actuators

Table 3. Operating Specifications (Mechanical)\*

Characteristic	Operating Head Code "A" Momentary
Pretravel	17.5° max.
Overtravel	60° min.
Differential travel	7° max.
Total travel	85° ref
Operating torque	0,452 Nm [4 in-lb] max.
Full travel torque	0,678 Nm [6 in-lb] max.

\* Operating point given in relation to lever mounting shaft

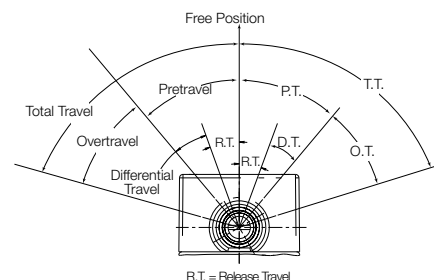

# WBX Series: Point-to-Point Network

Figure 3. Limitless™ WBX Series Pin Plunger Dimensions

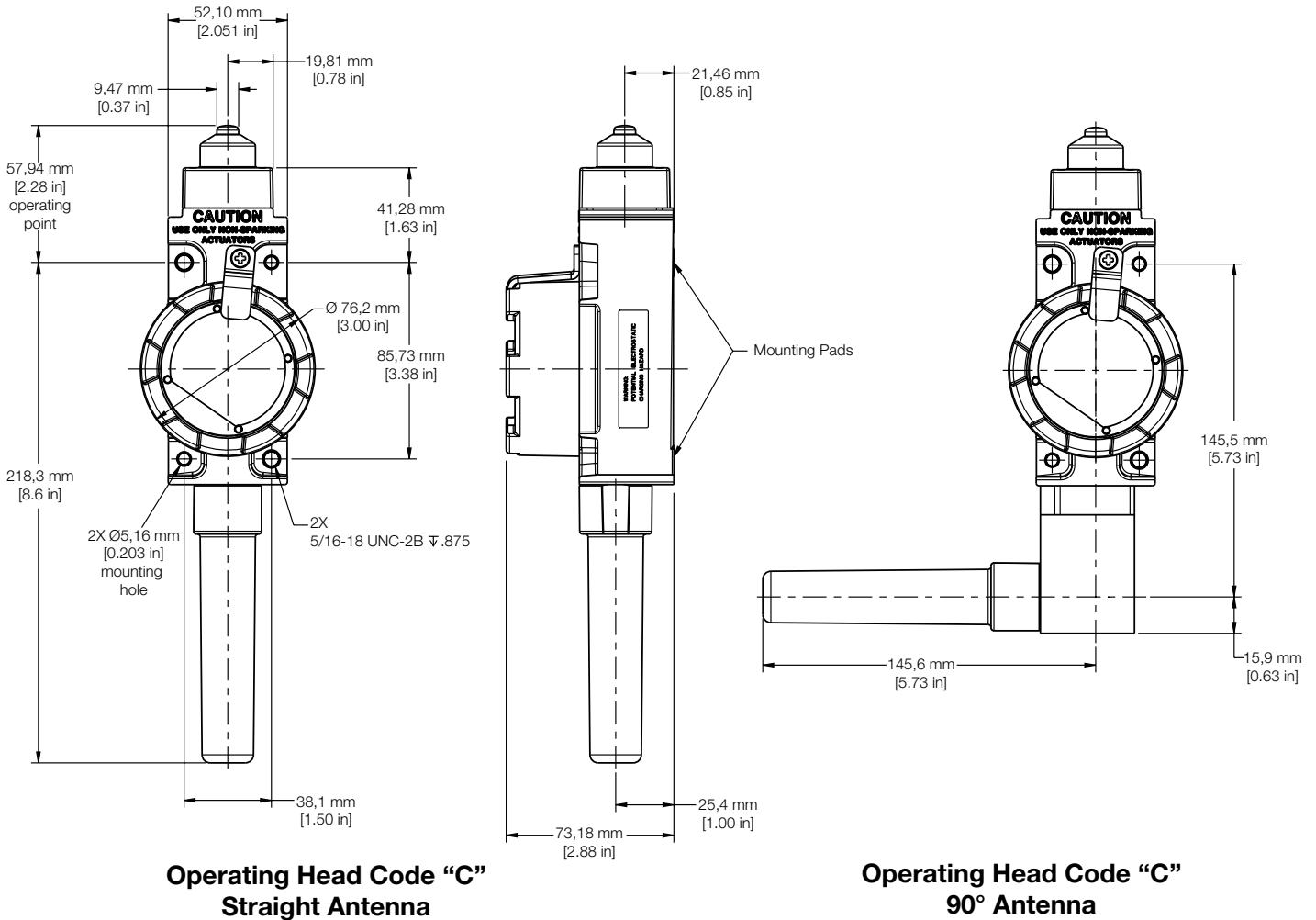

## MECHANICAL OPERATING SPECIFICATIONS

for Pin Plunger Actuators

Table 4. Operating Specifications (Mechanical)\*

Characteristic	Operating Head Code "C" Top Plunger Plain
Pretravel	1,78 mm [0.07 in max.]
Overtravel	4,83 mm [0.19 in min.]
Differential travel	0,51 mm [0.02 in max.]
Operating force	20,02 N [4.5 lb max.]
Operating point	57,94 mm ± 0,51 mm [2.281 in ± 0.02 in]
Full overtravel force	40 N [9 lb max.]

\* Operating point given in relation to top mounting hole

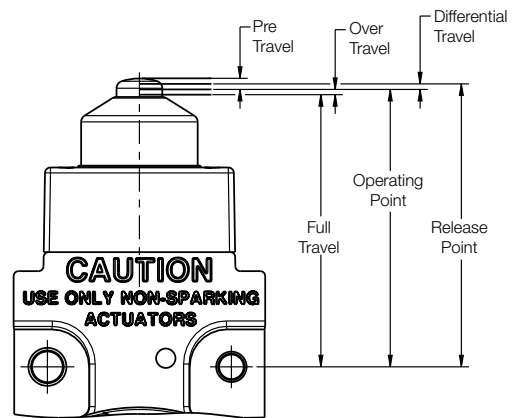



# Limitless™ Wireless Hazardous Area Limit Switches

Figure 4. Limitless™ WBX Series Wobble Dimensions

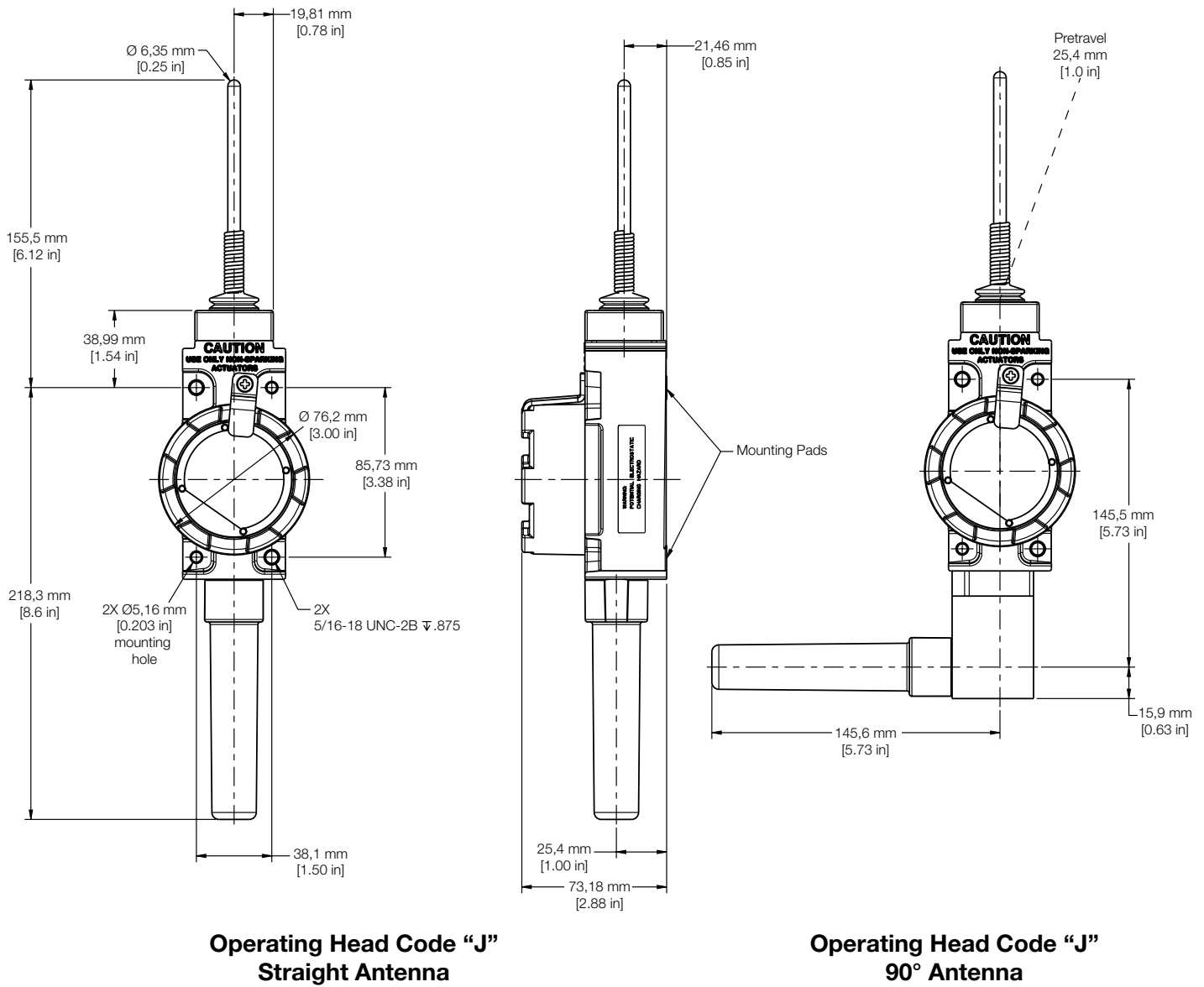

## MECHANICAL OPERATING SPECIFICATIONS

for Wobble Stick Actuators









Table 5. Operating Specifications (Mechanical)\*

Characteristic	Operating Head Code "J" Wobble Stick
Pretravel	25,4 mm [1.0 in] approx. radius
Operating force	283 g [10.0 oz] max.

# WBX Series: Point-to-Point Network





Table 6. WBX Series Available Levers

Note: In hazardous locations, non-sparking actuators are required.

		
<p><b>Fixed lever</b>  <b>LSZ51A</b> - front mount nylon roller  <b>LSZ51C</b> - back mount nylon roller</p>	<p><b>Short fixed lever</b>  <b>LSZ59A</b> - front mount nylon roller  <b>LSZ59C</b> - back mount nylon roller</p>	<p><b>Offset lever</b>  <b>LSZ55A</b> - back mount nylon roller  <b>LSZ55C</b> - front mount nylon roller</p>
		
<p><b>Adjustable lever</b>  <b>LSZ52A</b> - back mount nylon roller  <b>LSZ52C</b> - front mount nylon roller</p>	<p><b>Yoke lever</b>  <b>LSZ53A</b> - front/back mount nylon rollers</p>	<p><b>Rubber roller lever</b>  <b>LSZ51Y</b> - standard  <b>LSZ52Y</b> - adjustable  <b>LSZ55Y</b> - offset</p>
		
<p><b>LSZ52J</b>  adjustable lever, nylon roller 25,4 mm [1 in]</p>	<p><b>LSZ52K</b>  adjustable lever, nylon roller 38,1 mm [1.5 in]</p>	<p><b>LSZ54M</b>  aluminum rod 140 mm [5.5 in]</p>

# Limitless™ Wireless Hazardous Area Limit Switches

Table 7.WBX Series Lever Order Guide

	Catalog Listing	Material	Roller Dia. mm [in]	Roller Width mm [in]	Roller Mounting	
<b>Fixed 38,1 [1.5] inch radius</b>						
	LSZ51	Rollerless	n/a	n/a	n/a	
	LSZ51A	Nylon	19 [0.75]	6,35 [0.25]	Front	
	LSZ51C	Nylon	19 [0.75]	6,35 [0.25]	Back	
	LSZ51F	Nylon	25,4 [1.0]	12,7 [0.50]	Front	
	LSZ51G	Nylon	38,1 [1.5]	6,35 [0.25]	Front	
	LSZ51J	Nylon	25,4 [1.0]	12,7 [0.50]	Back	
	LSZ51M	Nylon	19 [0.75]	31,7 [1.25]	Back	
	LSZ51P	Nylon	19 [0.75]	12,7 [0.50]	Front	
	LSZ251A (sst)	Nylon	19 [0.75]	6,35 [0.25]	Front	
	LSZ251C (sst)	Nylon	19 [0.75]	6,35 [0.25]	Back	
	LSZ251E (sst)	Copper alloy	19 [0.75]	6,35 [0.25]	Front	
	LSZ251F (sst)	Copper alloy	19 [0.75]	6,35 [0.25]	Back	
	<b>Adjustable 38,1 [1.5] in to 3.5 in radius</b>					
		LSZ52	Rollerless	n/a	n/a	n/a
LSZ52A		Nylon	19 [0.75]	6,35 [0.25]	Back	
LSZ52C		Nylon	19 [0.75]	6,35 [0.25]	Front	
LSZ52E		Nylon	19 [0.75]	33,0 [1.30]	Front	
LSZ52J		Nylon	25,4 [1.0]	12,7 [0.50]	Front	
LSZ52K		Nylon	38,1 [1.5]	6,35 [0.25]	Front	
LSZ52M		Nylon	50,8 [2.0]	6,35 [0.25]	Front	
LSZ52N		Nylon	19 [0.75]	12,7 [0.50]	Front	
LSZ252A (sst)		Nylon	19 [0.75]	6,35 [0.25]	Front	
LSZ252C (sst)		Nylon	19 [0.75]	6,35 [0.25]	Back	
LSZ252E (sst)		Copper alloy	19 [0.75]	6,35 [0.25]	Front	
LSZ252F (sst)		Copper alloy	19 [0.75]	6,35 [0.25]	Back	
<b>Yoke – 38,1 [1.5] in radius</b>						
		LSZ53A	Nylon	19 [0.75]	6,35 [0.25]	Front/Back
	LSZ53E	Nylon	19 [0.75]	6,35 [0.25]	Back/Front	
	LSZ53M	Nylon	19 [0.75]	31,7 [1.25]	Back/Front	
	LSZ53S	Nylon	19 [0.75]	6,35 [0.25]	Back/Back	
<b>Rod</b>						
	LSZ54	Hub only	n/a	n/a	n/a	
	LSZ54P	Plastic rod, 305 mm [12 in]	Ø6,85 [Ø 0.27]	n/a	n/a	
	LSZ54W	Plastic rod, 183 mm [7.2 in]	Ø6,85 [Ø 0.27]	n/a	n/a	

	Catalog Listing	Material	Roller Dia. mm [in]	Roller Width mm [in]	Roller Mounting
<b>Offset – 38,1 [1.5] in radius</b>					
	LSZ55	Rollerless	n/a	n/a	n/a
	LSZ55A	Nylon	19 [0.75]	6,35 [0.25]	Back
	LSZ55C	Nylon	19 [0.75]	6,35 [0.25]	Front
	LSZ55E	Nylon	19 [0.75]	12,7 [0.50]	Front
	LSZ55K	Nylon	38,1 [1.5]	6,35 [0.25]	Front
<b>Short fixed - 1.3 in radius</b>					
	LSZ59A	Nylon	19 [0.75]	6,35 [0.25]	Front
	LSZ59C	Nylon	19 [0.75]	6,35 [0.25]	Back
<b>Rubber roller levers</b>					
	LSZ51Y 38,1 [1.5] radius (standard)	Rubber	50 [2.0]	12,7 [0.5]	front
	LSZ55Y 38,1 [1.5] radius (offset)	Rubber	50 [2.0]	12,7 [0.5]	front
	LSZ52Y 38,1 to 89 [1.5 to 3.5] radius (adjustable)	Rubber	50 [2.0]	12,7 [0.5]	front









\* May require orientation of switch and lever to enable gravity to help restore switch to free position.

# WBX Series: Point-to-Point Network

**Table 8. Antenna Listings/Order Code Specifications**







Antennas can be ordered with the Limitless™ Wireless switches by inserting the **Antenna Type Code** into the part number as shown in the nomenclature. Also, switches can be ordered without antennas, by using the “00” Antenna Type Code in the part number. Antennas may also be ordered separately using the **Part Numbers** below.

**Table 8. Antenna Options - Country Code A**

Ant. type code		Part number	Replacement antenna mount or cable	Antenna design	Ant. gain (max.)	Connector/mounting	Dimensions	Antenna material	Cable material/type	Mount material
00		WAN03RSP	–	flat	3.0 dBi	RP-SMA plug/adhesive mount	115 mm L x 22,1 mm W x 4,57 mm D [4.53 in L x 0.87 in W x 0.18 in D] 3 m [9.8 ft] cable	UV stable ABS	UV stable PVC/ RG-174 coax	–
00		WAN04RSP	WAMM100RSP-005 base with 1,52 m [5 ft] of cable	tilt/ swivel	5.5 dBi	RP-SMA plug/direct mount	Ø 12,7 mm x 208,28 mm L [Ø 0.50 in x 8.20 in L]	UV stable molded polyurethane	UV stable PVC/ RG-174 coax	UV stable black ABS
00		WAN04RSP	WAMM100RSP-010 base with 3,05 m [10 ft] of cable	tilt/ swivel	5.5 dBi	RP-SMA plug/direct mount	Ø 12,7 mm x 208,28 mm L [Ø 0.50 in x 8.20 in L]	UV stable molded polyurethane	UV stable PVC/ RG-174 coax	UV stable black ABS
00		WAN05RSP	WAMM100RSP-005 base with 1,52 m [5 ft] of cable	tilt/ swivel	9.0 dBi	RP-SMA plug/direct mount	Ø 12,7 mm x 384,05 mm L [Ø 0.50 in x 15.12 in L]	UV stable molded polyurethane	UV stable PVC/ RG-174 coax	UV stable black ABS
00		WAN05RSP	WAMM100RSP-010 base with 3,05 m [10 ft] of cable	tilt/ swivel	9.0 dBi	RP-SMA plug/direct mount	Ø 12,7 mm x 384,05 mm L [Ø 0.50 in x 15.12 in L]	UV stable molded polyurethane	UV stable PVC/ RG-174 coax	UV stable black ABS
00		WAN06RNJ	WCA200RN-PRSP-002 coax cable assembly 0,682 m [2 ft]	straight	8.0 dBi	RP-N jack/ bracket	Ø 33,5 mm x 427,9 mm L [Ø 1.32 in x 16.85 in L]	UV stable fiberglass	UV stable PVC/ RG-316 coax, UV stable Polyethylene/200 Series coax	300 series SST aluminum alloy
00		WAN06RNJ	WCA200RN-PRSP-010 coax cable assembly 3,05 m [10 ft]	straight	8.0 dBi	RP-N jack/ bracket	Ø 33,5 mm x 427,9 mm L [Ø 1.32 in x 16.85 in L]	UV stable fiberglass	UV stable PVC/ RG-316 coax, UV stable Polyethylene/200 Series coax	300 series SST aluminum alloy
00		WAN08RSP	–	90°	0 dBi	RP-SMA plug/direct mount	Ø 8,0 mm x 29 mm L [Ø 0.34 in x 1.14 in L]	UV stable	–	–
00		WAN09RSP	–	low profile mobile	3.0 dBi	RP-SMA plug/magnetic	Ø 76,2 mm x 115 mm L [Ø 3.0 in x 4.54 in L] 4,57 m [15 ft] cable	UV stable ABS plastic	UV stable black PVC	Nickel-plated steel
00		WAN10RSP	–	straight	5.0 dBi	RP-SMA plug/magnetic	Ø 76,2 mm x 230,1 mm L [Ø 3.0 in x 9.06 in L] 4,57 m [15 ft] cable	Nickel-plated steel	UV stable black PVC	Nickel-plated steel
00		WAN11RSP	–	low profile mobile	4.0 dBi	RP-SMA plug/thru-hole screw	Ø 39 mm x 42,4 mm L [Ø 1.54 in x 1.67 in L]	UV stable black PVC	UV stable black PVC	Nickel-plated steel
12		WAN12RSP	–	straight	2.0 dBi	RP-SMA plug/direct mount	Ø 10 mm x 79,5 mm L [Ø 0.39 in. x 3.13 in. L]	UV stable ABS plastic	–	–

# Limitless™ Wireless Hazardous Area Limit Switches

Table 9. Antenna Options - Country Code B

Ant. type code		Part number	Replacement antenna mount or cable	Antenna design	Ant. gain (max.)	Connector/mounting	Dimensions	Antenna material	Cable material/ type	Mount material
00		WAN03RSP	–	flat	3.0 dBi	RP-SMA plug/adhesive mount	115 mm L x 22,1 mm W x 4,57 mm D [4.53 in L x 0.87 in W x 0.18 in D] 3 m [9.8 ft] cable	UV stable ABS	UV stable PVC/ RG-174 coax	–
00		WAN04RSP	WAMM100RSP-005 base with 1,52 m [5 ft] of cable	tilt/ swivel	5.5 dBi	RP-SMA plug/direct mount	Ø 12,7 mm x 208,28 mm L [Ø 0.50 in x 8.20 in L]	UV stable molded polyurethane	UV stable PVC/ RG-174 coax	UV stable black ABS
00		WAN04RSP	WAMM100RSP-010 base with 3,05 m [10 ft] of cable	tilt/ swivel	5.5 dBi	RP-SMA plug/direct mount	Ø 12,7 mm x 208,28 mm L [Ø 0.50 in x 8.20 in L]	UV stable molded polyurethane	UV stable PVC/ RG-174 coax	UV stable black ABS
00		WAN08RSP	–	90°	0 dBi	RP-SMA plug/direct mount	Ø 8,0 mm x 29 mm L [Ø 0.34 in x 1.14 in L]	UV stable	–	–
00		WAN09RSP	–	low profile mobile	3.0 dBi	RP-SMA plug/magnetic	Ø 76,2 mm x 115 mm L [Ø 3.0 in x 4.54 in L] 4,57 m [15 ft] cable	UV stable ABS plastic	UV stable black PVC	Nickel-plated steel
00		WAN10RSP	–	straight	5.0 dBi	RP-SMA plug/magnetic	Ø 76,2 mm x 230,1 mm L [Ø 3.0 in x 9.06 in L] 4,57 m [15 ft] cable	Nickel-plated steel	UV stable black PVC	Nickel-plated steel
00		WAN11RSP	–	low profile mobile	4.0 dBi	RP-SMA plug/thru-hole screw	Ø 39 mm x 42,4 mm L [Ø 1.54 in x 1.67 in L]	UV stable black PVC	UV stable black PVC	Nickel-plated steel
12		WAN12RSP	–	straight	2.0 dBi	RP-SMA plug/direct mount	Ø 10 mm x 79,5 mm L [Ø 0.39 in. x 3.13 in. L]	UV stable ABS plastic	–	–

# WBX Series: Point-to-Point Network

## ACCESSORIES

Table 10. Replacement Parts



	Part Number	Description
	WAN12RSP	2.4 GHz, 2.0 dBi RP-SMA WLAN antenna
	WAN20RAD	Replacement WBX radome

Table 11. Cable and Coax Accessories











	Part Number	Description
	WCA200RNPRSP-002	Limitless™ Series wireless cable assembly with 200 Series cable, 2 ft length, reverse polarity N plug to reverse polarity SMA plug, use only with WAN06RNJ antenna
	WCA200RNPRSP-010	Limitless™ Series wireless cable assembly with 200 Series cable, 10 ft length, reverse polarity N plug to reverse polarity SMA plug, use only with WAN06RNJ antenna
	WCA200RNJRSP-002	Limitless™ Series wireless cable assembly with 200 Series cable, 2 ft length, reverse polarity SMA jack to reverse polarity SMA plug
	WCA200RNJRSP-005	Limitless™ Series wireless cable assembly with 200 Series cable, 5 ft length, reverse polarity SMA jack to reverse polarity SMA plug
	WCA200RNJRSP-010	Limitless™ Series wireless cable assembly with 200 Series cable, 10 ft length, reverse polarity SMA jack to reverse polarity SMA plug
	WCA200RNJRSP-015	Limitless™ Series wireless cable assembly with 200 Series cable, 15 ft length, reverse polarity SMA jack to reverse polarity SMA plug
	WCA200RNJRSP-020	Limitless™ Series wireless cable assembly with 200 Series cable, 20 ft length, reverse polarity SMA jack to reverse polarity SMA plug







Table 12. Base Accessories

	Part Number	Description
	WAMM100RSP-005	Magnetic antenna base with 1,52 m [5 ft] of cable
	WAMM100RSP-010	Magnetic antenna base with 3,05 m [10 ft] of cable
	WPB1	WPMM Wireless panel mount receiver mounting bracket
	WPR1	WPMM panel mount retainer

# Limitless™ Wireless Hazardous Area Limit Switches

Table 13. Catalog Listings

This Honeywell datasheet supports the following Limitless™ WBX Series Catalog Listings

	Part number	Description
	WBX1A00ABA	Limitless™ WBX Series Hazardous Area Limit Switch, RP-SMA antenna jack, side rotary momentary, IEEE 802.15.4 radio specification
	WBX1A12ABA	Limitless™ WBX Series Hazardous Area Limit Switch, 2.0 dBi omni w/switch mount; straight design, side rotary momentary, IEEE 802.15.4 radio specification
	WBX1A00ABA3	Limitless™ WBX Series Hazardous Area Limit Switch, RP-SMA antenna jack, side rotary momentary to right, IEEE 802.15.4 radio specification
	WBX1A12ABA3	Limitless™ WBX Series Hazardous Area Limit Switch, 2.0 dBi omni w/switch mount; straight design, side rotary momentary to right, IEEE 802.15.4 radio specification
	WBX1A00ABA4	Limitless™ WBX Series Hazardous Area Limit Switch, RP-SMA antenna jack, side rotary momentary to left, IEEE 802.15.4 radio specification
	WBX1A12ABA4	Limitless™ WBX Series Hazardous Area Limit Switch, 2.0 dBi omni w/switch mount; straight design, side rotary momentary to left, IEEE 802.15.4 radio specification
	WBX1A00ABC	Limitless™ WBX Series Hazardous Area Limit Switch, RP-SMA antenna jack, top pin plunger, IEEE 802.15.4 radio specification
	WBX1A12ABC	Limitless™ WBX Series Hazardous Area Limit Switch, 2.0 dBi omni w/switch mount; straight design, top pin plunger, IEEE 802.15.4 radio specification
	WBX1A00ABJ7A	Limitless™ WBX Series Hazardous Area Limit Switch, RP-SMA antenna jack, wobble stick, IEEE 802.15.4 radio specification
	WBX1A12ABJ7A	Limitless™ WBX Series Hazardous Area Limit Switch, 2.0 dBi omni w/switch mount; straight design, wobble stick, IEEE 802.15.4 radio specification
	WBX1A14ABA	Limitless™ WBX Series Hazardous Area Limit Switch, 2.0 dBi omni w/switch mount; right angle design, side rotary momentary, IEEE 802.15.4 radio specification
	WBX1A14ABC	Limitless™ WBX Series Hazardous Area Limit Switch, 2.0 dBi omni w/switch mount; right angle design, pin plunger, IEEE 802.15.4 radio specification

## ADDITIONAL INFORMATION

The following associated literature is available on the Honeywell web site at [sensing.honeywell.com](http://sensing.honeywell.com):

- Product installation and technical manual (32307000)
- Product range guide
- Product nomenclature tree
- Limitless™ product brochure
- Product application-specific information
  - Application flyer: Increase employee safety with layers of protection: Limitless™ safety shower and eye wash alarm solutions
  - Application note: Limitless™ wireless hazardous location switch for grain handling
  - Application note: Limitless™ wireless hazardous location switch for valve position detection
  - White paper: Wireless switches offer unlimited benefits

### Find out more

Honeywell serves its customers through a worldwide network of sales offices, representatives and distributors. For application assistance, current specifications, pricing or name of the nearest Authorized Distributor, contact your local sales office.

To learn more about Honeywell's sensing and control products, call **+1-815-235-6847** or **1-800-537-6945**, visit **[sensing.honeywell.com](http://sensing.honeywell.com)**, or e-mail inquiries to **[info.sc@honeywell.com](mailto:info.sc@honeywell.com)**

Sensing and Control  
Honeywell  
1985 Douglas Drive North  
Golden Valley, MN 55422  
**[honeywell.com](http://honeywell.com)**

### **WARNING**

#### **PERSONAL INJURY**

**DO NOT USE** these products as safety or emergency stop devices or in any other application where failure of the product could result in personal injury.

**Failure to comply with these instructions could result in death or serious injury.**

### **WARNING**

#### **MISUSE OF DOCUMENTATION**

- The information presented in this product sheet is for reference only. Do not use this document as a product installation guide.
- Complete installation, operation, and maintenance information is provided in the instructions supplied with each product.

**Failure to comply with these instructions could result in death or serious injury.**

## WARRANTY/REMEDY

Honeywell warrants goods of its manufacture as being free of defective materials and faulty workmanship. Honeywell's standard product warranty applies unless agreed to otherwise by Honeywell in writing; please refer to your order acknowledgement or consult your local sales office for specific warranty details. If warranted goods are returned to Honeywell during the period of coverage, Honeywell will repair or replace, at its option, without charge those items it finds defective. **The foregoing is buyer's sole remedy and is in lieu of all other warranties, expressed or implied, including those of merchantability and fitness for a particular purpose. In no event shall Honeywell be liable for consequential, special, or indirect damages.**

While we provide application assistance personally, through our literature and the Honeywell website, it is up to the customer to determine the suitability of the product in the application.

Specifications may change without notice. The information we supply is believed to be accurate and reliable as of this printing. However, we assume no responsibility for its use.

# Honeywell