

4

3

2

1

THIS DRAWING IS UNPUBLISHED.

RELEASED FOR PUBLICATION

© COPYRIGHT BY TYCO ELECTRONICS CORPORATION.

ALL RIGHTS RESERVED.

LOC FB DIST 00

REVISIONS

P	LTR	DESCRIPTION	DATE	DWN	APVD
0	RELEASED	FB00-0013-03	23JAN03	J.J	T.S

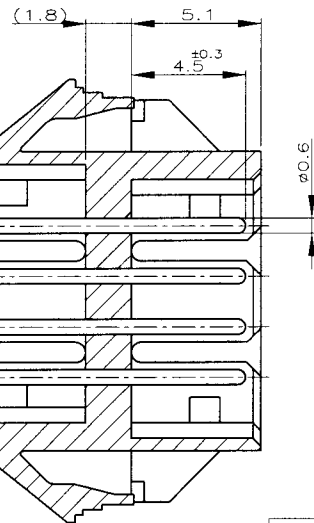
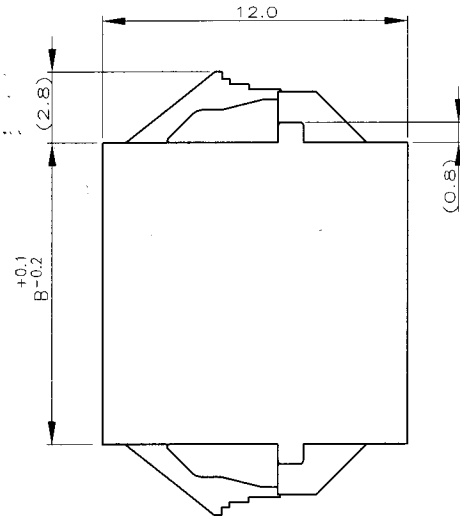
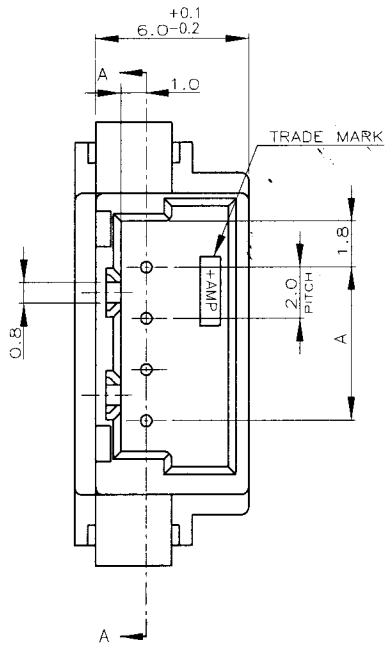

SECT. A-A

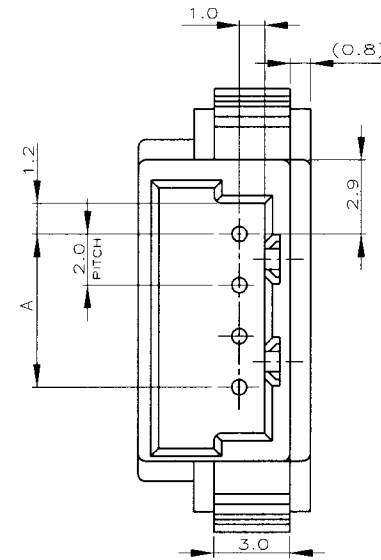

NOTES;

- MATERIAL: HOUSING - 66 NYLON (UL94V-0)
POST - TIN BRASS
- THE PANEL SHOULD BE PUNCHED SO THAT THE HOUSING ENTERS THE PANEL IN THE SAME DIRECTION AS PUNCH.

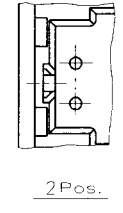
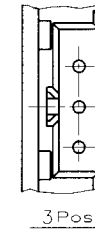

7-292254-5	5-292254-5	3-292254-5	1-292254-5	15	37.6	34.0	33.8	28.0
7- -4	5- -4	3- -4	1- -4	14	35.6	32.0	31.8	26.0
7- -3	5- -3	3- -3	1- -3	13	33.6	30.0	29.8	24.0
7- -2	5- -2	3- -2	1- -2	12	31.6	28.0	27.8	22.0
7- -1	5- -1	3- -1	1- -1	11	29.6	26.0	25.8	20.0
7- -0	5- -0	3- -0	1- -0	10	27.6	24.0	23.8	18.0
6- -9	4- -9	2- -9		9	25.6	22.0	21.8	16.0
6- -8	4- -8	2- -8		8	23.6	20.0	19.8	14.0
6- -7	4- -7	2- -7		7	21.6	18.0	17.8	12.0
6- -6	4- -6	2- -6		6	19.6	16.0	15.8	10.0
6- -5	4- -5	2- -5		5	17.6	14.0	13.8	8.0
6- -4	4- -4	2- -4		4	15.6	12.0	11.8	6.0
6- -3	4- -3	2- -3		3	13.6	10.0	9.8	4.0
6-292254-2	4-292254-2	2-292254-2	292254-2	2	11.6	8.0	7.8	2.0
BLACK	YELLOW	BLUE	NATURAL	Pos.	D	C	B	A

PANEL CUTOUT DIMENSION (TOLERANCE:±0.1)
(RECOMMENDED PANE THICKNESS:0.8mm ~ 1.6mm)

TOLERANCES UNLESS OTHERWISE SPECIFIED:

- 10 > * : ±0.2
- 30 > * > 10 : ±0.25
- 100 > * > 30 : ±0.3
- ANGLE : ±3°

THIS DRAWING IS A CONTROLLED DOCUMENT.

DIMENSIONS: MM

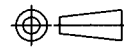

SEE NOTE

TOLERANCES UNLESS OTHERWISE SPECIFIED:

- 0 PLC ±
- 1 PLC ±
- 2 PLC ±
- 3 PLC ±
- 4 PLC ±
- ANGLES ±
- FINISH ±

SEE NOTE

DWN S.XU 31JAN03

CHK S.YAO 31JAN03

APVD T. SASAKI 31JAN03

PRODUCT SPEC

APPLICATION SPEC

WEIGHT

CUSTOMER DRAWING

tyco Tyco Electronics Corporation
SHANGHAI, CHINA

NAME: PANEL MOUNT TYPE RELAY POST HEADER ASS'Y
(AMP CT CONNECTOR 2mm PITCH)

SIZE: A3 CAGE CODE: 00779 DRAWING NO: C-292254 RESTRICTED TO: -

SCALE: 5:1 SHEET: 1 OF 1 REV: 0