

Weller®

Founded in 1945, Weller has become the world's leading supplier of professional quality soldering equipment, including the famous Weller temperature controlled irons and soldering guns. Weller makes advanced soldering and desoldering stations and irons for sophisticated industrial needs, plus a series of handy soldering and miniature power tool kits for home craftsmen, hobbyists and light industry.



WMD3K2
WMD3K2 multi digital
desoldering station
with soldering irons



WQB4000SOPS
BGA & QFP
Rework Station



WMD1A & Multi Purpose Station



WD1000AU
WD1 digital soldering station with
WP80 soldering iron

Magnastat Controlled Station

The Weller Magnastat system operates through a ferro-magnetic sensing device which changes its characteristics when a specific temperature is reached. This causes it to either attract or repel a permanent magnet which operates a power supply switch. In this way power to the heating element can be quickly switched on or off to either provide extra power for soldering operations or reduced power when idling. Working temperature selection is achieved by simply changing the 'temperature sensing' soldering tip. These are available in temperature ratings of 315°C, 371°C and 427°C. The tips are made of pure copper for effective heat conductivity. The heating element has an optimal heating effect on the tip. This is possible through high precision of the tubes, the winding and insulation, which means that the heating element should never be gripped with pliers or be hammered in any way. It is quite sufficient to secure the soldering tip by tightening it into the tip sleeve by hand (when the iron is cold).

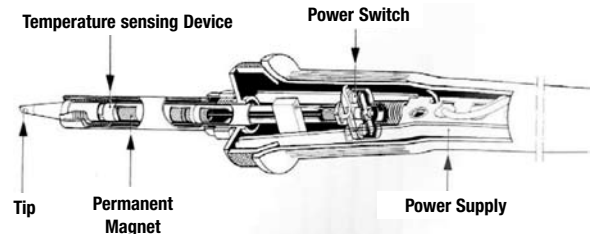

Description	Material No.	Shelf Pack
WTCPTD Soldering station consists of: <ul style="list-style-type: none"> • TC202DT2 230V Power Unit • TC201B 42 Watt 24V Pencil • PH1201 Stand • 1.6mm 700°F/371°C tip Soldering Tips: PT-Series see page 24	WTCPTD	1

Temperature Controlled Stations



WHS40
Soldering Station - 40W/230V

- The temperature range can be controlled between 200°C and 450°C
- The WHS40 soldering station from Weller rules out the risk of temperature shocks which can occur with conventional soldering bits.
- Desired temperatures can be set precisely in such a way that you no longer have to worry about overheating sensitive areas.
- Consists of power unit, soldering iron with nickel plated 2.00mm tip and support.



WHS40D
Soldering Station - 40W/230V - Digital

- 2mm straight nickel tip
- The new electronically controlled soldering station WHS40D operates with a temperature range of 150°C - 450°C.
- The precise soldering tip temperature shows on the digital read-out (pre-set and real value).
- This soldering station is suitable for delicate soldering tasks on temperature sensitive components.
- LED to monitor the heater is integrated in the display.
- The temperature adjusts via buttons.
- Consists of power unit, soldering iron with "Longlife" tip 2.0mm and support.

T0056806599	1
T0056828599	1

Electronically Controlled Stations

The Weller WES51D and WESD51D have been developed to provide precision electronic soldering at an affordable price. The tip temperature is electronically controlled and is within a tolerance of +/- 3%





Description	Material No.	Shelf Pack
<p>WES51D An economical soldering station with High-End Performance. Ideal for continuous production soldering.</p> <ul style="list-style-type: none"> • Analogue temperature control • Temperature lockout • Automatic shut off • Slim comfortable pencil reduced operator fatigue • Temperature range 150°C-450°C • Max. power output 50W • Assembled in Australia <p>Soldering station consists of:</p> <ul style="list-style-type: none"> • WES51DPU 230V Power Unit • PES51 50 Watt 24V Pencil • PH50 Holder • ETA tip <p>Soldering Tips: ET-Series see page 25</p>	<p>WES51D</p> 	1





<p>WESD51DAU Ideal for production, rework and repair of through hole SMT boards, some ground planes and multi-layer boards.</p> <ul style="list-style-type: none"> • Digital microprocessor temperature control with LED display • Wireless temperature lockout tool • Automatic shut off • Tip temperature offset • °C-°F switchable • Temperature range 150°C-450°C • Max. power output 50W • Assembled in Australia <p>Soldering station consists of:</p> <ul style="list-style-type: none"> • WESD51DPU 230V Power Unit • PES51 50 Watt 24V Pencil • PH50 Holder • ETA tip 	<p>WESD51DAU</p> 	1
---	---	---















<p>WD1AU 80W Power Unit with Digital Display - Single port</p> <ul style="list-style-type: none"> • 3 "radio buttons" allows to pre-set frequently used temperature settings • Extensive Special Functions menu allows you to utilize access features • Setback, lockout, temp. window, F/C switching, standby, auto-off time • Large high contrast LCD display displays more information at a glance • Compatible with WP80 and WMP soldering pencils • ESD safe to protect sensitive components • ROHS & WEEE Compliant 	<p>WD1AU</p>  	1
---	---	---



<p>WD1MAU 80W High Performance Power Unit - Single port</p> <ul style="list-style-type: none"> • 3 "radio buttons" allows to pre-set frequently used temperature settings • Extensive Special Functions menu allows you to utilize access features • Setback, lockout, temp. window, F/C switching, standby, auto-off time • Large high contrast LCD display displays more information at a glance • Compatible with WP80, WMP, WMRT and WMRP soldering pencils • ESD safe to protect sensitive components • USB Interface & Software • ROHS & WEEE Compliant 	<p>WD1MAU</p>  	1
--	--	---

Electronically Controlled Stations (cont'd)

Description	Material No.	Shelf Pack
 <p>WD1000AU A new concept in soldering iron design.</p> <ul style="list-style-type: none"> • Digital temperature control • Temperature lockout • Automatic shut off • Unique miniature pencil • 3 Pre-set temperature buttons • °C-°F switchable • Temperature range 50°C-450°C • Max. power output 80W • Made in Germany <p>Soldering station consists of:</p> <ul style="list-style-type: none"> • WD1 230V Power Unit • WP80 80 Watt 24V Pencil • WDH10 Holder • LTB tip • ROHS & WEEE Compliant 	<p>WD1000AU</p>  	1
 <p>WD1001AU</p> <ul style="list-style-type: none"> • Similar to WD1000AU with WMP soldering tool and WDH20 holder. 	<p>WD1001AU</p>  	1
 <p>WD1000MAU Micro Digital Rework Soldering Station,</p> <ul style="list-style-type: none"> • Designed for fine pitch, high density SMT soldering and rework • 3 "radio buttons" allows pre-set of frequently used temp settings • Setback, lockout, temp. window, F/C switching, standby, auto-off time • Large high contrast LCD display displays more information at a glance • The heating element is contained in the tip for fast heat-up • WMRP Pencil is made of aluminum with chrome plating and weighs just 75g • The pencil powers down when placed in the holder to extend tip life • The "tip to grip" distance is 45mm, placing you close to the work • The antistatic design of the safety rest has got four different settings • ESD safe to protect sensitive components • ROHS & WEEE Compliant • Max. Power Output 80W; Consists of WMRP 40W Micro Soldering Pencils with RT3 Tip and WDH50 Holder 	<p>WD1000MAU</p>  	1
 <p>NEW</p> <p>WD1000HPT The WD 1000HPT station features Weller's new 120 W soldering iron, the WP 120. This iron is ideal for soldering on difficult circuit boards with heat sinks that cause dissipation in heat transfer. Target applications include high density circuit boards, High Frequency / Radio Frequency applications, and solar panel production.</p> <p>The Weller WD1000HPT station is specifically designed for soldering operations which need a combination of high energy and maximum precision.</p> <p>The WD1000 HPT consists of-</p> <ul style="list-style-type: none"> • The WD120 Soldering Iron • XT Series Tips, refer page 29 • The WD1M Power Unit • WDH10T Stop + Go Iron Safety Rest • Dimensions (L x W x H mm): 134 x 108 x 147 • Mains voltage supply: 230V / 120V / 50/60 Hz • Power: 160W • Safety class: I (power unit), III (soldering iron) • Temperature control: 50°C - 450°C • Temperature accuracy: ± 9°C • Temperature stability: ± 5°C • Soldering tip leakage resistance: < 2 Ω (tip-to-ground) • Soldering tip leakage current: < 2 mV (tip-to-ground) 	<p>WD1000HPTAU</p>  	1

Electronically Controlled Stations (cont'd)



Description

WD2AU
Micro Digital Rework Soldering Station, 160W Power Unit with Digital Display - Dual port

- 3 "radio buttons" allows to pre-set frequently used temperature settings
- Extensive Special Functions menu allows you to utilize access features
- Setback, lockout, temp. window, F/C switching, standby, auto-off time
- Large high contrast LCD display displays more information at a glance
- Compatible with WP80 and WMP soldering pencils
- ESD safe to protect sensitive components
- ROHS & WEEE Compliant

Material No.	Shelf Pack
WD2AU	1



WD2MAU
160W Power Unit with Digital Display - 2 Port

- 3 "radio buttons" allows to pre-set frequently used temperature settings
- Extensive Special Functions menu allows you to utilize access features
- Setback, lockout, temp. window, F/C switching, standby, auto-off time
- Large high contrast LCD display displays more information at a glance
- Compatible with WP80, WMP, WMRP and WMRT soldering pencils
- ESD safe to protect sensitive components
- USB Interface & Software
- ROHS & WEEE Compliant

WD2MAU	1
--------	---



WD2000AU
Dual Channel Digital Soldering Station

- Microprocessor-controlled soldering station in a modern ergonomic design for Weller soldering tools up to 150 W
- Temperature control 50°C-450°C (150°C-550°C with WSP 150)
- Big LCD display
- Three fixed temperatures can be assigned with the temperature buttons
- The following settings are possible without any accessory unit: custom-designed calibration function, programmable temperature decrease (setback), interlock functions and remote ID for ISO applications
- The antistatic design of the safety rest has got four different setting
- Protection class I (controll unit), protection class III (soldering iron)
- Max. Power Output 160W; RoHS & WEEE Compliant; consists of 2 x WP80 80W Soldering Pencil with LTB Tips, 2 x WDH10 Stand

WD2000AU	1
----------	---



WD2001AU
Dual Channel Digital Soldering Station







- Microprocessor-controlled soldering station in a modern ergonomic design for Weller soldering tools up to 150 W
- Temperature control 50°C-450°C (150°C-550°C with WSP 150)
- Big LCD display
- Three fixed temperatures can be assigned with the temperature buttons
- The following settings are possible without any accessory unit: custom-designed calibration function, programmable temperature decrease (setback), interlock functions and remote ID for ISO applications
- The antistatic design of the safety rest has got four different settings
- Protection class I (controll unit), protection class III (soldering iron)
- Output 160W; RoHS & WEEE Compliant; consists of 1 x WP80 80W Soldering Pencil with LTB Tip & WDH10 Holder, 2 x WMP 65W Soldering Pencils with Tips & 2 x WDH20 Stands

WD2001AU	1
----------	---



Electronically Controlled Stations (cont'd)



Description	Material No.	Shelf Pack
<p>WD2002AU Dual Channel Digital Soldering Station</p> <ul style="list-style-type: none"> • Microprocessor-controlled soldering station in a modern ergonomic design for Weller soldering tools up to 150 W • Temperature control 50°C-450°C (150°C-550°C with WSP 150) • Big LCD display • Three fixed temperatures can be assigned with the temperature buttons • The following settings are possible without any accessory unit: custom-designed calibration function, programmable temperature decrease (setback), interlock functions and remote ID for ISO applications • The antistatic design of the safety rest has got four different settings • Protection class I (control unit), protection class III (soldering iron) • Max. Power Output 160W; RoHS & WEEE Compliant; consists of 1 x WP80 80W Pencil, 1 x WMP 65W Soldering Pencil with Tips, 1 x WDH10 & 1 x WDH20 Stands 	<p>WD2002AU</p>  	1
<p>WD2000MAU Dual Micro Digital Rework Station</p> <ul style="list-style-type: none"> • Use WMRP solder pencil and WMRT desoldering tweezers simultaneously • Designed for fine pitch, high density SMT soldering and rework • 3 "radio buttons" allows pre-set of frequently used temp settings • Setback, lockout, temp. window, F/C switching, standby, auto-off time • Large high contrast LCD display displays more information at a glance • The "tip to grip" distance of the WMRP pencil is just 45mm • WMRT tweezers utilize a tip cartridge that is always in alignment • Tweezers are automatically switched off when placed in the WMRT holder • ESD safe to protect sensitive components • ROHS & WEEE Compliant • Max. Power Output 160W; RoHS & WEEE Compliant; Consists of WMRP 40W Micro Soldering Pencil with RT3 Tip and WDH50 Holder, WMRT 80W Micro Desoldering Tweezers with RTW2 Tip and WMRT Holder 	<p>WD2000MAU</p>  	1
<p>WD3MAU The Weller® WD 3M is a versatile unit for use in industrial, production, engineering, repair and laboratory applications to carry out professional repair work on electronic assemblies using the latest technology. The WD 3M enables the combined use of Weller's new High-Power Irons and Micro-Tools to handle modern HF-shielded and SMT-flooded electronics.</p> <ul style="list-style-type: none"> • The WD 3M has 3 independent channels for the simultaneous operation of 3 soldering tools • Precise temperature control at the soldering tip is guaranteed by Weller's digital control technology and superior sensor and heat-transfer technology • High-speed measured-value acquisition gives maximum temperature precision and optimal dynamic temperature performance in load situations • The temperature can be adjusted in the range 50°C - 450°C for WP80/WP120 and other soldering tools. • Three temperature buttons to set fixed temperatures directly. <p>Benefits from various outstanding functions of the WD 3M!</p> <ul style="list-style-type: none"> • Automatic tool detection and activation of corresponding control parameters • Digital temperature control • Option of inputting offset values • Programmable temperature reduction (setback) • Standby and lock functions • Antistatic device design in accordance with ESD safety • Different equipotential-bonding possibilities on the device (standard configuration hard grounded) • Customer-specific calibration function • USB port for control, evaluation and documentation via PC • Dimensions (L x W x H): 273 x 235 x 102 mm • Mains voltage supply: 230V / 120V / 50/60 Hz • Power: 420 W • Safety class: I and III • Temperature control: 50°C - 450°C • Temperature accuracy: ± 9°C • Temperature stability: ± 2°C 	<p>WD3MAU</p>  	1

Electronically Controlled Stations (cont'd)

NEW



Description

WD3000HPT
 WD3000HPT Soldering Station 420W, 230V
 WP 120 High-Power Soldering Pencil for HF shieldings, Micro-Tools for handling of small and sensitive SMT components.
 Three channels with High-Speed-Regulation for all Micro-Tools and the High-Power WP 120 Soldering Pencil.
 Includes:
 • WD 3M Power Unit
 • WP 120 High Performance Soldering Pencil, 120W
 • WDH 10T Safety Rest with Stop + Go function
 • WMRP Micro Pencil, 40W
 • WDH 50 Safety Rest with Stop + Go function
 • WMRT Micro Tweezers, 80W (2 x 40W)
 • WMRTH Safety Rest with Stop + Go function
 Technical Data:
 • Dimensions (L x W x H): 237 x 235 x 102mm, 10.75 x 9.25 x 4.02 inches
 • Mains voltage: 230V / 50/60 Hz
 • Power input: max. 420W
 • Protection class: 1
 • Temperature control: 50°C-450°C (150°F-850°F)
 • Temperature accuracy: ± 9°C (± 17°F)
 • Temperature stability: ± 5°C (± 9°F)
 • Tip-to-ground resistance: < 2 Ω
 Potential-free plug (factory set hard grounded)

Description	Material No.	Shelf Pack
WD3000HPT	WD3000HPTAU	1

NEW



WD3002HPT
 WD3002HPT Soldering Station 420W, 230V
 One station, two High-Power Soldering Pencils for different applications or parallel work.
 Three channels with High-Speed-Regulation for all Micro-Tools and High-Power Soldering Pencil WP 120.
 Includes:
 • WD 3M Power Unit
 • WP120 High-Power Soldering Pencil, 120W 2x
 • WDH 10T Safety Rest with Stop + Go function 2x

WD3002HPT	WD3002HPTAU	1
-----------	-------------	---



WSD151
 Extremely high output soldering station delivering 150 watts
 • Digital microprocessor temperature control with LED display
 • Automatic shut off
 • Calibration box (WCB1 or WCB2) may be connected
 • °C-°F switchable
 • Temperature range 50°C-550°C
 • Max. power output 150W
 • ROHS & WEEE Compliant
 • Made in Germany
 Soldering station consists of
 • PUD151 230V Power Unit
 • WSP150 150 Watt 24V Pencil
 • KH27 Holder
 • LHT-F tip

WSD151	T0053277599	1
--------	-------------	---

















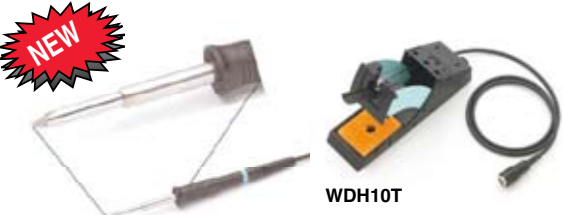





Tool Selection Chart

Station	Tools																						
	TC201	TC201B	PRS50	PCS51	WSP80	WP80	WMP	WSP150	WMRP	WMRT	WTA50	DSB200C	DS160		HAP200		WHP380		WSP150		WST62	WP120	
WTCPT	◆																						
WTCPTD		◆																					
WESS0D			◆																				
WESS1D				◆																			
WESD51D				◆																			
WSD81					◆	◆	◆				◆						◆	◆		◆	◆		
WSL					◆	◆	◆				◆						◆	◆		◆	◆		
WSD151					◆	◆	◆	◆			◆						◆	◆	◆	◆	◆		
WSD161					◆	◆	◆	◆			◆						◆	◆	◆	◆	◆		
WMRS					◆	◆	◆		◆	◆	◆						◆	◆	◆	◆	◆		
WD1000AU					◆	◆	◆				◆						◆	◆		◆	◆		
WD1001AU					◆	◆	◆				◆						◆	◆		◆	◆		
WD2000AU					◆	◆	◆				◆						◆	◆		◆	◆		
WD2001AU					◆	◆	◆				◆						◆	◆		◆	◆		
WD2002AU					◆	◆	◆				◆						◆	◆	◆	◆	◆		◆
WD1000MAU					◆	◆	◆		◆	◆	◆						◆	◆		◆	◆		◆
WD2000MAU					◆	◆	◆		◆	◆	◆						◆	◆	◆	◆	◆		◆
WD1AU					◆	◆	◆				◆						◆	◆		◆	◆		◆
WD2AU					◆	◆	◆				◆						◆	◆	◆	◆	◆		◆
WD1MAU					◆	◆	◆		◆	◆	◆						◆	◆	◆	◆	◆		◆
WD2MAU					◆	◆	◆		◆	◆	◆						◆	◆	◆	◆	◆		◆
WD3MAU					◆	◆	◆				◆						◆	◆		◆	◆		◆
WMD1					◆	◆	◆				◆	◆	◆	◆			◆	◆		◆	◆		◆
WMD1A					◆	◆	◆				◆	◆	◆	◆			◆	◆		◆	◆		◆
WMD1D					◆	◆	◆				◆	◆	◆	◆			◆	◆		◆	◆		◆
WMD3					◆	◆	◆				◆	◆	◆	◆			◆	◆		◆	◆		◆
WMD3K2					◆	◆	◆				◆	◆	◆	◆			◆	◆		◆	◆		◆
WR3M					◆	◆	◆		◆	◆	◆					◆	◆	◆	◆	◆	◆		◆
WR3000M					◆	◆	◆		◆	◆	◆					◆	◆	◆	◆	◆	◆		◆

Optional Accessories

	Description	Material No.	Shelf Pack
	WP80 80 Watt Soldering Pencil with Short Tip-To-Grip • Compatible with WD1 and WD2 Soldering Stations, and WRS Rework Stations • New WP80 offers 80 watts of power with short tip-to-grip (40 mm) • New WP80 has same performance characteristics as the WSP80 • Perfect for Lead Free solder • ESD safe to protect sensitive components • ROHS & WEEE Compliant • See page 26 for LT tips, Accessories and Spares • Spare element NOT available (sealed to handle)	T0052918099 	1
	WP80 Set • Consists of: • WP80 soldering pencil • WDH10 support • ROHS & WEEE Compliant • See page 26 for LT Tips	T0052918199 	1
	WP80 Barrel for WP80 Pencil	T005874484	1
	WP120 Soldering Iron • Twice as much power and efficiency in a small and ergonomic pencil design • Powerful heating element with a replaceable soldering tip • Best life cycle cost at dynamic performance • The rapid transfer of heat into the soldering tip is quickly and precisely controlled with sophisticated electronics • Design copes with big and difficult solder joints even at barely accessible joints • Also ideal for HF shield plates or solar panel manufacturing	T0052919399 	1
	WP120 Set • Consists of: • WP120 soldering pencil • WDH10T Stop + Go Stand • ROHS & WEEE Compliant • See page 29 for XT tips	T0052919499 	1

Optional Accessories (cont'd)

Description	Material No.	Shelf Pack
 <p>WMP SET 65 watt micro soldering pencil and WDH20 Holder</p>	T0052917999	1
 <p>WMRP Soldering pencil for RT soldering tips</p> <ul style="list-style-type: none"> • ROHS & WEEE Compliant • 40 watt Micro Soldering Pencil Set with high speed regulation <p>See page 28 for RT tips</p>	T0052917199	1
 <p>WMRP SET</p> <p>Consists of:</p> <ul style="list-style-type: none"> • WMRP 40 W Pencil • WDH50 Stand 	T0052919099	1
 <p>WMRT Micro Desoldering Tweezers with rest for WMRS, WD 1M, WD 2M</p> <p>The new WMRT desoldering tweezers enables with its twin parallel adjusted tiplets a significant precise de- and soldering of very small SMD components. The high speed regulation of the stations WMRS, WD 1M, WD 2M drives this tweezers. Placed in the rest WMRTH the tips are automatically switched off for increasing endurance.</p> <ul style="list-style-type: none"> • ROHS & WEEE Compliant 	T0051317399	1
 <p>WSP150 150 watt soldering pencil for heavy duty work</p> <ul style="list-style-type: none"> • ROHS & WEEE Compliant <p>See page 28 for LHT tips</p>	T0052917099	1
 <p>WSP150 SET</p> <p>Consists of:</p> <ul style="list-style-type: none"> • WSP150 Soldering Tool • WDH30 Stand 	T0052918999	1
 <p>PES50 50 watt soldering iron to suit WES50D</p> <p>PH50 Stand not included</p>	PES50	1
 <p>PES51 50 watt soldering iron to suit WES51D and WESD51D</p> <p>See page 25 for ET tips</p> <p>PH50 Stand not included</p>	PES51	1
 <p>EC1201AP 40 watt soldering pencil with stand</p>	EC1201AP	1
 <p>See page 25 for ET tips</p>		

Optional Accessories (cont'd)



Description	Material No.	Shelf Pack
DSX80 Iron 80 Watt Desoldering Pencil <ul style="list-style-type: none"> • Temperature range 50°C-450°C • RPHS & WEEE Compliant See page 33 for DX tips	T0051319099 	1
DSX80 SET Consists of: <ul style="list-style-type: none"> • DSX80 Desoldering Tool • WDH30 sStand 	T0051318399 	1
WTA-50 SET The WTA-50 tweezers can be used with all Weller Temtronic/SL series stations. Dual heating elements with independent temperature sensors provide the tips with constant temperature. Temperature range 150°C - 450°C Output 2 x 25W Consists of: <ul style="list-style-type: none"> • Desolder Tweezer • AK51 Support • Hex Key Supplied with WT1 tip See page 30 for WT tips <ul style="list-style-type: none"> • ROHS & WEEE Compliant 	T0053313399 	1
HAP1 SET 100 Watt HAP1 Hot Air Pencil & WDH30 Stand. For both soldering and desoldering of SMD's. Temperature range 50°C - 550°C Power absorption 100W Consists of: <ul style="list-style-type: none"> • HAP1 hot air pencil • WDH30 Safety Rest • 1.2mm nozzle • Xcelite Nutdriver P8 MM See page 35 for nozzles <ul style="list-style-type: none"> • ROHS & WEEE Compliant 	T0052711899 	1
HAP200 SET Hot Air Pencil set 200W, 24V The HAP200 provides a directional hot air flow that is adjustable. Electronic temperature control from 50°C to 550°C. Different nozzles available as accessory. Finger switch controls the adjustable pump. For WR 3M only.	T0052711799 	1
HAP200 Nozzle Adapter See page 32 for Nozzles	T0058761728	1
WHPS80 Preheat plate <ul style="list-style-type: none"> • 80 watt • 50°C-200°C • 80 x 50mm • for use with WSD81, WSD151, WMD series • ROHS & WEEE Compliant 	T0052702899 	1

Optional Accessories (cont'd)



Description

WHP200 Infrared Under Board Heater
The new WHP200 from Weller is a new under board heater which although small in dimensions is very powerful. The WHP200 is designed to be used on small multipayer PCBs to minimise the risk of thermal damage to boards and to speed up the repair process.

- Universal application
The WHP200 is suitable for use with a range of consumer electronic boards. It is perfect for rework operations on digital camera, mobile phones, MP3 players and PDA pcbs
- Fast and efficient heating
The infrared plate provides fast, precisely controlled heating to create an even substrate temperature
- Operating simplicity
The WHP200 is simple to use with very easy adjustment for the heating temperature. The heating plate comes complete with a pcb board holder so there is no need to buy additional accessories
- Excellent Price-/Performance ratio
The WHP under board heater provides an excellent Price-/Performance balance
- Dimensions (L x W x H):
193 x 193 x 84 mm
inc. pcb holder 7,6 x 7,6 x 3,3 inch
- Dimensions Heating Zone (L x W):
120 / 60 mm; 4,72 / 2,36 inch
- Voltage: 230 V / 50/60 Hz
- Power: Heat Zone 200 W
Medium Wave Infrared
- Safety Class: I
- Regulation: 50°C - 400°C

Material No.	Shelf Pack
T0053371599	1



WRK Rework Nozzle Kit
The newly developed, innovative desoldering system facilitates soldering and desoldering of large SMT components up to 30 x 30 mm. The desoldering system can be connected to the additional vacuum channel (pick up) of the WR 3M.

- 8 Nozzles
- Assorted Vacuum Cups
- 2 Vacuum Rods and Hose
- Stand

T0051515599	1
-------------	---



WSB80
80 Watt Solder Bath is a very useful rework preparation tool. The solder bath is temperature controlled continuously between 50°C to 450°C via an existing 80W power source (WSD81, WMD series). The solder bath can be used to tin wire ends and leads of all extraneous solder particles in preparation for reworking.

- 150x120x65mm
- Warm up time (approx) 7 minutes
- ROHS & WEEE Compliant

T0052704099	1
-------------	---



WSB150
150 Watt Solder Bath. Accessory for WD2, and WD2M Power Units.

- For tin coating and preparation of electronics components and leads
- Also used to clean excess solder from component leads
- Compatible with lead free solders

T0052704299	1
-------------	---



WST20 Thermal stripping tool 50 W, 24 V
The WST20 temperature controlled thermal stripping tool is suitable to all digital Weller stations. It strips off thermoplastic insulation materials by using precisely shaped stripping blades. The stripping length is adjustable up to 30mm.

T0052503099	1
-------------	---

Optional Accessories (cont'd)



Description	Material No.	Shelf Pack
WST82 Thermal Stripping Tool 80 W, 24 V, with flexcord. The WST82 temperature controlled thermal stripping tool is suitable to all digital Weller stations with minimum 80 W. It strips off thermoplastic insulation materials by using precisely shaped stripping blades. The stripping length is adjustable up to 30 mm. Optimal temperature control via power unit (accessory).	T0052503199 	1

Soldering pencils, Magnastat temperature controlled, low voltage



TC201B Magnastat Tool suits WTCPTD 42W 24V	TC201B	1
TCP12 Magnastat Tool 40W 12V	TCP12	1
TCP50M Magnastat Tool 40W 50V	TCP50M	1
TC201 Magnastat Tool suits WTCPS/T 40W 25V	TC201	1

Soldering pencils, temperature controlled, line voltage



W60D Magnastat Tool 60W	W60D	1
W100D Magnastat Tool 100W	W100D	1
W201D Magnastat Tool 200W	T0056107599	1

See page 34 for Tips

Tool Stands



PH1201 Tool Stand for TCP, TC, EC and SP	PH1201	1
PH50 Tool Stand for PES50 and PES51	PH50	1
PH1260 W60D Tool Stand	PH1260	1
PH12100 W100D Tool Stand	PH12100	1
WDH10 Support for WSP80 & WP80 with four different settings	T0051512199	1
WDH20 Support for WMP with four different settings	T0051512299	1
WDH30 Tool Stand for HAP200 & DS x 80	T0051515299	1
WDH40 Tool Stand for DX80	T0051515399	1
WDH50 Tool Stand for WMRP	T0051515699	1
WDH10T WP80 Stop-N-Go Stand	T0051516199	1
WDH20T WMP Stop-N-Go	T0051516299	1
AK51 Stand for WTA50	T0051504299	1
AK20 Stand for DS80UNC	T0051503099	1
AKV Stand for DSV80UNC / DSX80	T0051503899	1

Tool Stands Chart

Tools	STANDS													
	PH1201	PH50	WDH10	WDH20	WDH30	WDH40	WDH50	WDH10T	WDH20T	PH1260	PH12100	AK20	AK51	AKV
TCP	♦													
TC	♦													
EC	♦													
SP	♦													
EC1302B	♦													
PES50		♦												
PES51		♦												
WSP80			♦					♦						
WSP150					♦									
WP80			♦					♦						
WMP				♦					♦					
WMRP							♦							
WMRT														
WVP														
WTA-50														
HAP1						♦						♦		
HAP200						♦								
DS80UNC / DSV						♦								
DSX80						♦								♦
W60D										♦				
W100D											♦			

Fume Extraction Stands



Description	Material No.	Shelf Pack
PH1201F As per PH1201 but allows for fume extraction (not micro irons) Stand for TC201 & EC Series.	PH1201F	1
WPH80 Stand for WSP80 & WSP81	T0051514099	1

Soldering Aids



W101CH Miniature temperature controlled solder bath (330°C) with horizontal stand.
100W 230V Consists of:

- 100W Solder Bath with Insert
- Support for Solder Bath

ESF-120ESD
Printed circuit board holder

- Adjustable to Eurocard size
- Suitable for holding irregular shaped cards
- Component support

WPBI Polishing Bar

- Rejuvenates tips without damage to the plated surface

WLSK200 Vacuum pen for easy pick up of small components.
Fully self contained.

SD1000 Solder Dispenser

- For coils up to 1000g
- For use of coil up to length 95mm, core Ø > 17mm
- length 84mm, core Ø < 12mm

ABW2 Extension for additional reel

- To be fixed on SD1000
- For coils up to 1000g
- For use of coil up to length 95mm, core Ø > 17mm
- length 70mm, core Ø < 12mm
- length 84mm, core Ø < 12mm

WDC Dry Cleaning System

- Very effective cleaning from oxides on solder tips especially when using lead free solder.
- Good stability (does not slide on work bench)
- Longer life of metal wool due to tapping of the solder into the box before cleaning.
- Metal wool does not contain flux.
- User may use any flux which is accepted for his process.
- Cleaning result will be even better if wool is wetted with flux.

WDC2 Dry Cleaner Attachment

WDC Wire Wool 2 Refills

W101CH	1	
T0051502699	1	
WPBI	1	
WLSK200	1	
T0051301799	1	
T0051301399	1	
T0051512499	1	
		
		
T0051512599	1	
T0051382499	1	

De-Soldering Pump



WDS De-Soldering Pump

- High Suction Power, Lightweight
- Ideal for PC Board Repairing
- Clean the cylinder occasionally

Electronic Temperature Measuring Equipment



Description	Material No.	Shelf Pack
WTT1 Temperature measurement and calibration. <ul style="list-style-type: none"> Measures temperature without imposing thermal load. The WTT1 digital temperature measuring system has been specifically designed for measuring the temperature of soldering iron tips. The probe has a double sensor system and internal heat source. The measured temperature is fed to a control system that records the flow of heat in the probe and stabilizes it with the aid of the internal heat source. This design ensures that no heat is drawn by the probe from the object being measured. Erroneous measurements due to the large thermal load of the probe are thus prevented. The measured temperature is indicated on a three-digit LED display to a resolution of 1°C. An adjustable preheat temperature ensures a rapid response even at high temperatures.	T0053124699	1
WCB2 As for WCB1 with the following additional features: <ul style="list-style-type: none"> Thermo couple input for automatic calibration. RS232 output 	T0053118099	1

Portable Soldering Tools



ML500MP Magna-Lite Butane Soldering Iron <ul style="list-style-type: none"> Applications include soldering, heat shrink tubing, electrical, electronics, field service repair Waterproof piezo ignition for fast, reliable ignition Adjustable flame height Temperature adjustable from 400°C to 510°C 30 minute run time Also operates as a torch when soldering tip is removed Refills with standard butane gas (Weller BR200) 	ML500MP	4
WHK30AU 30 Watt / 230 V - Woodburning & Hobby Kit <ul style="list-style-type: none"> 15 piece set, including 12 tips, ideal for wood burning, sculpting, adding accents, stencil cutting, pattern transfers, hot knife cutting, embossing and branding 30 Watt short barrel Woodburning Iron Set contains 6 Woodburning tips, Hot Knife Tip with Blade Chuck, Pattern Transfer Tip, 3 Branding Tips, Iron Stand and complete Project Book Boxed in plastic presentation case 	WHK30AU	6
BP860MPA Dual Heat Battery Powered Cordless Soldering Iron <ul style="list-style-type: none"> Perfect tool for light duty soldering jobs where portability is necessary Solders up to 180 solder joints per battery charge Medium Duty - 8 to 11 Watts Dual Heat gives two different working temperatures - 450°C and 500°C 	BP860MPA	5
BP10 Conical Tip BP11 Chisel Tip	BP10 BP11	



Portable Soldering Tools



Description	Material No.	Shelf Pack
<p>WPSI12V 12 Volt Portable Soldering Iron</p> <ul style="list-style-type: none"> • 42 Watt Battery Powered, with temperature control • Powered by a 12 Volt, 7.2 amp hour sealed lead acid battery • Fitted with an automotive cigarette lighter plug for direct connection to other 12 Volt power sources • 21 types of PT series tips available in 315°C, 371°C & 427°C • Battery life of 2-8 hours dependant on usage • Fluoro yellow carry pack with high visibility reflective strip, carry strap & soldering tool stand • 3 stage automatic battery charger included <p>NSN: 3439-66-155-0279</p>	WPSI12V	1

Weller® Pyropen



<p>WPA2 Piezo ignition (self) lighting. Kit includes:</p> <ul style="list-style-type: none"> • 1 x WPT-2 soldering tip • 1 x WHC-52 hot blow tip • Metal kit box <p>See page 32 for tip selection</p>	WPA2	1
<p>WSTA3 Soldering, hot blow and torch flame facilities. kit includes:</p> <ul style="list-style-type: none"> • 1 x soldering tip • 1 x hot blow tip • torch ejector tightening bar • Metal Kit box <p>See page 32 for tip selection</p>	WSTA3	1
<p>WSTA6 Junior pocket size with auto ignition</p> <ul style="list-style-type: none"> • Fitted with pocket clip • Suitable for soldering and hot blow applications • 1 x WPT-01 tip <p>See page 31 for tip selection</p>	WSTA6	1
<p>WSTA5 Jumbo, (self igniting) Kit includes:</p> <ul style="list-style-type: none"> • Soldering Tip 72-01-02 • Hot Blow Tip 72-01-52 • Metal kit box <p>See page 31 for tip selection</p>	WSTA5	1

Weller® Portasol



<p>PSI100K Piezo ignition (self lighting). Kit includes</p> <ul style="list-style-type: none"> • 1 x soldering, hot blow and cutting tip • Torch flame facility <p>Tips Include:</p> <ul style="list-style-type: none"> • PSI - 6, PSI - 8, PSI - 9, PSI - 10 <p>See page 32 for Portasol tip selection</p>	PSI100K	1
<p>BR200 Weller Butane Gas refill, 200 grams. Suitable for all above irons.</p>	BR200	12

Repair/Rework Stations

All Weller repair and rework stations feature automatic tool recognition and will accept any Weller temtronic tool including the WTA50, desoldering tweezers, WSB80 and WSB150 solder baths and WST20 thermal strippers. These stations have a built in pump to supply vacuum for desoldering and air for hot air soldering and desoldering. Special desoldering heads for SMD components removal are available. A finger switch control on the desoldering tool handle and hot air pencil will operate the air pump. SMD components can be lifted off with the vacuum of the desolder head. The hot air pencil (HAP1) is used for reflowing with solder paste or desoldering. Smaller components can be removed with the standard nozzle. Larger components can be desoldered with a suitable nozzle.



Description

WMD3K2

- A multi digital 310W desoldering station.
- 3 Channel
 - Temperature Range 50°C-450°C (Hot Air 500°C)
 - Air Volume Hot Air 1-10 l/min
 - Maximum Vacuum -0.7 bar
 - Temperature, Vacuum and Air Control via Station
 - 3 position Digital Display
 - Protection Class 1
 - Antistatic Housing
 - Automatic Tool Recognition
 - Consists of: WMD3 Control Unit, WP80 80W Soldering Iron, WDH10 Stand for WP80, DSX80 80W Desoldering Iron, AK20 Stand for DSX80, DX112 & DX113 Desoldering Nozzles, Cleaning Set, WDC Dry Cleaner

Material No.

T0053302659

Shelf Pack

1



WMD1D

- A multipurpose station to handle all rework and repair requirements.
- Digital microprocessor provides complete accuracy and reliability
 - Self contained air & vacuum
 - Programmable temperature, hot air flow and automatic set-back
 - Operator lock out prevents unauthorised changes
 - Temperature range, hot air 50°C-550°C, solder and desolder 50°C-450°C
 - Idle temperature set-back, 5-60 minutes
 - Large range of optional tools
 - Made in Germany
- Station consists of:
- WMD1S Power uni
 - DSX80 desoldering tool
 - ROHS & WEEE Compliant

T0053333599

1



Desoldering Tippets: DSX-Series see page 33



WMD1A

- A multipurpose station to handle all rework and repair requirements.
- Digital microprocessor provides complete accuracy and reliability
 - Self contained air & vacuum
 - Programmable temperature, hot air flow and automatic set-back
 - Operator lock out prevents unauthorised changes
 - Temperature range, hot air 50°C-550°C, solder and desolder 50°C-450°C
 - Idle temperature set-back, 5-60 minutes
 - Large range of optional tools
 - Made in Germany
- Station consists of:
- WMD1S Power unit
 - HAP1 hot air pencil
 - ROHS & WEEE Compliant

T0053330699

1







Hot Air Nozzles: see page 35

Repair/Rework Stations



reddot design award
winner 2007



Description	Material No.	Shelf Pack
<p>WR3M Package includes:</p> <ul style="list-style-type: none"> • WR 3M repair station • Adapter for HAP200 hot-air pencil • CD with USB software • USB cable <p>Technical data:</p> <ul style="list-style-type: none"> • Dimensions L x W x H (mm): 237 x 235 x 102 • Weight: approx. 6.7 kg • Mains supply voltage: 230 V, 50 Hz (120 V, 60 Hz) • Power consumption: 420 W • Safety class: I and III, housing antistatic • Fuse: Overcurrent release 2 A (4 A) • Temperature control Soldering and Desoldering iron stepless of channels: 50°C-550°C • Controllable temperature range is tool-dependent • Temperature accuracy: ± 9°C • Temperature stability: ± 2°C • Pump (periodic duty (30/30) s): Max. vacuum 0.7 bar • Max. delivery rate 18 l/min • Hot air max. 15 l/min • Additional Pump: Max. vacuum 0.5 bar • Max. delivery rate 1.7 l/min • Equipotential bonding: Via 3.5 mm pawl socket on back of device 	<p>T0053366699</p>  	1
<p>WR3000MAU Rework Set Package includes:</p> <ul style="list-style-type: none"> • WR3M • HAP200 Hot-air pencil with WDH30 Safety rest • DSX80 Desoldering iron with WDH30 Safety rest • WP80 Soldering iron with WDH10 Stop + go Safety rest • WVP Vacuum pick up • WDC2 Dry cleaner <p>Technical data:</p> <ul style="list-style-type: none"> • Dimensions: L x W x H (mm): 237 x 235 x 102 • Weight: approx. 6.7 kg • Mains supply voltage: 230 V, 50 Hz (120 V, 60 Hz) • Power consumption: 420 W • Safety class: I and III, housing antistatic • Fuse: Overcurrent release 2 A (4 A) • Temperature control Soldering and Desoldering iron stepless of channels: 50°C-550°C • Controllable temperature range is tool-dependent • Temperature accuracy: ± 9°C • Temperature stability: ± 2°C • Pump (periodic duty (30/30) s): Max. vacuum 0.7 bar • Max. delivery rate 18 l/min • Hot air max. 15 l/min • Additional Pump: Max. vacuum 0.5 bar • Max. delivery rate 1.7 l/min • Equipotential bonding: Via 3.5 mm pawl socket on back of device 	<p>WR3000MAU</p>  	1





Hot Air Stations

The advanced technology of Weller hot air stations ensures greater controlled precision when soldering and desoldering sensitive SMD components. Medium to large SMD components are extremely susceptible to thermal and physical damage. Weller hot air stations provide gentle, controlled hot air flow being directed to the leads of the component. An in-built vacuum pick-up within the nozzle of the WHA2000 makes the removal and replacement of the component safe and easy without damaging the circuit board pads or component leads.



Dimensions 240 x 270 x 170 (W x L x H mm)
Mains Voltage: 230V
Max Heat Power: 700 w
Temp Range: 50°C - 550°C







Description	Material No.	Shelf Pack
<p>WHA3000P Hot Air Station</p> <ul style="list-style-type: none"> • 700 watt hot air station with patented Weller nozzle technology for maximum process control. • The powerful variable speed controlled turbine generates an air volume of up to 50 litres/min. • An ion trap so that charge free hot air is directed at the component. • Memory space to store up to 10 thermal profiles to ensure process repeatability • The WHA 3000P will perform demanding repair tasks on circuit boards with complex fine pitch surface mounted components. • The advanced control technology coupled with user friendly operation, guarantees precision of repair processes. • Extensive range accessories compliment the machine to promote flexibility. • Foot pedal available. • ROHS & WEEE Compliant 	<p>T0053334699</p>  	1
<p>WHA3000PS SET Set contains:</p> <ul style="list-style-type: none"> • WHA3000P Hot Air Station • WBH Circuit board holder • WHP3000 Heating plate 	<p>T0053355699</p>  	1
<p>WHP3000 Heating Plate - 600W</p> <ul style="list-style-type: none"> • The WHP 3000 increases the flexibility of the WHA systems. • It provides underside heating to the board under repair, reducing the heat requirement from the hot air pencil and therefore minimising the risk of thermal damage to the board as well as speeding up the repair process. • The heated surface comprises 3 high temperature ceramic elements that ensure fast and efficient heating. • IR Heating plate total heated area 120 mm x 190 mm with 3 ceramic elements. • Set temperatures and actual temperatures are digitally displayed. • An external sensor can be connected to display actual temperatures at specific areas of the circuit under repair. • The hot plate can be controlled from its own internal control system or integrated into the control system of the WHA 3000P/V • ROHS & WEEE Compliant 	<p>T0053338699</p> 	1
<p>WHP3000 Heating Plate 1200 W, 230 V, 190 x 245 mm same as WHP 3000 but with heatable surface 190 x 245 mm Heating plate 1200 W, 230 V</p> <ul style="list-style-type: none"> • ROHS & WEEE Compliant 	<p>T0053364699</p>	1

Hot Air Stations



Dimensions 440 x 320 x 446 (W x L x H mm)



Description	Material No.	Shelf Pack
<p>WBHS Circuit Board Holder & Pivoting Stand</p> <ul style="list-style-type: none"> Retains and secures the circuit board under repair and allows positioning of the board in X and Y directions. A wide range of accessories available separately permits boards up to a max size of 310mm x 320mm both single and double sided to be accommodated in a perfectly flat condition. The WBH 3000S incorporates a pivoting stand to mount the HAP 3000 hot air pencil. This stand allows the HAP 3000 to be raised and lowered onto the component under repair. An added safety feature is the Stop + Go function, which will automatically switch the hot air pencil into a standby mode if the stand is pivoted to the side of the board holder without first switching off the hot air. The pre-heating plate WHP 3000 (supplied separately) can be fitted under the board holder to provide background heating. ROHS & WEEE Compliant 	<p>T0053316399</p>  	1
<p>WBH PCB Holder</p> <ul style="list-style-type: none"> Holds circuit boards up to 310 x 320 mm in the x-y direction The WHP3000 heating plate can be slid under the PCB holder Same as WBH3000S but without pivoting hot air tool holder 	<p>T0053316499</p> 	1
<p>WHA900 Hot air station 700W with built-in turbine</p> <p>Low cost hot air station for less complex repair tasks and hot air applications such as shrinking. The in-built turbine provides hot air and variable temperatures. The temperature of the hot air is electronically controlled.</p> <ul style="list-style-type: none"> Analogue temperature adjustment Temperature range 50°C-550°C Air Volume 5-50 l/min (ESD Safe) Two rotary potentiometers to set air temperature and air volume Standby and calibration function Safety Class I ROHS & WEEE Compliant 	<p>T0053171699</p>  	1

Repair/Rework BGA/QFP Stations

Weller remains at the forefront of Rework Technology. As on board components have become more and more complex Weller has led the field with innovative, user friendly repair and assembly tools that solve the rework problem. The introduction of the BGA was no exception, with its small footprint area, hidden connections, and high connection density, rework operators have been presented with very real placement and removal problems. The WQB 3000 machines are the second generation of the Weller BGA/SMT repair system. They meet the exceptional demands required of a modern rework tool and deliver the benefits at a value for money price. Weller has developed a comprehensive user friendly program for the removal and re-balling of BGA components, site preparation, solder paste printing, placement and re-flow, without the risk of thermal damage to the component or the circuit board. No matter what the component, BGA, QFN, QFP, PLCC, SOP, PGA or surface mounted sockets, Weller has the rework answer.

Due to the rapid advances in SMD component development, increasingly complex processes are demanded for assembly and rework. Ball Grid Array and fine pitch leaded component rework require considerable technical expertise to achieve a successful repair. The Weller WQB 3000 system has this capability.

The Rework Cycle:

Development of the temperature profile

- Repeatable results can only be achieved by a process cycle that considers all the parameters of the repair operation.
- To allow removal of the component from a circuit board without damage to the board, a temperature profile of the operation must be established. The "Self Teach" feature of the WQB 3000 provides a quick and easy method of finding the parameters of the process cycle, without the need of in depth operator knowledge.

Component Removal

- Necessary for successful re-flow of the solder joints is the ability to preheat the circuit board and a temperature/time controlled process.
- A vacuum actuated lift to automatically remove the component from the board with minimum force at the end of the re-flow cycle to ensure no damage to the solder pads.

Cleaning of the circuit board

- Residual solder should be removed from the board with a desoldering iron or desolder wick.
- Residual contaminants should be removed with a suitable solvent spray.

Solder Application.

- Stencil printing should be used to apply fresh solder to the pads; this ensures that the correct volume of solder paste is deposited.

Positioning of the component

- A precise positioning system is required to place components with hidden joints, Weller offers two distinct systems.
- WQB 3000 uses the patented Weller template positioning process, a low cost but precise operation.
- A wide range of templates, for BGA, QFP and PLCC components are available
- WQB 3000 OPS uses a computer aided camera placement system, which is particularly useful if it is necessary to place a wide range of components.

Soldering of the component

- Re-flow of the replaced component is a repeat of the removal process except the vacuum lift is not initiated at the end of the profile.
- To cater for the many body sizes of BGA devices, a wide range of hot gas nozzles are available.
- To solder QFP and PLCC packages, an adapter is available to permit the use of the Weller NQ/ND family of hot gas nozzles.

Inspection of the solder joint

- Once the rework process has been verified by inspection of the completed repair, and then the repeatable profile controlled by the stored program can be applied ensuring that all subsequent repairs are carried out to the same parameters reducing the necessity of inspection to a minimum.

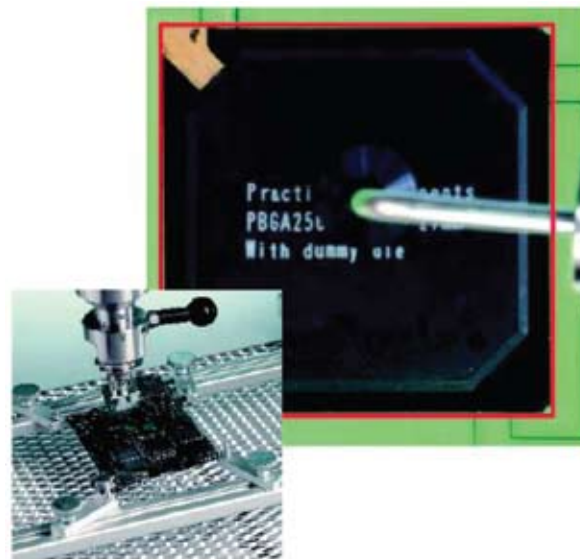

Repair/Rework BGA/QFP Stations

The new QWB Repair System upgrades the Weller product range in the SMD repair tool sector. A well thought-out design concept combines reliability and maximum process control with ease of use and technically mature detail solutions. Useful accessories increase the possible uses of this repair work station.

On the QWB 3000 the temperature-regulated 2-zone infrared bottom heater provides rapid warm up and homogeneous substrate temperatures. The hot gas top heater, with digital control electronics for temperature monitoring and regulation of the air flow rate, facilitates the finely metered supply of heat to the components.

A temperature sensor placed directly in the hot gas nozzle efficiently regulates the top heater and thus provides maximum process control.

Large chip removal station with high energy handpiece. Extensive assortment of economically priced nozzles, with custom sizes made to order.

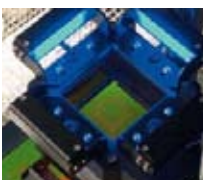
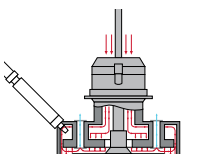
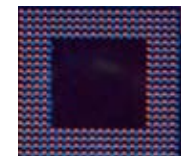

Description

WQB4000SOPS

Weller's next-generation repair and rework station combines a completely new design with state-of-the-art split optic camera technology to provide users with absolute reliability, optimum process control and enhanced ease of use.

- **Advanced design for enhanced precision**
The WQB4000SOPS is modularly built with a slide platform, advanced patented systems and materials of the highest quality to guarantee industrial reliability and long-lasting durability.
- **Heating from above: selective and sensitive**
The hot gas heater with patented nozzle system, coupled with digital control electronics for temperature monitoring and regulation of the air flow rate, facilitates the finely metered supply of heat to the components. A temperature sensor placed directly in the hot gas nozzle prevents thermal overload of the component and efficiently regulates the top heater, providing maximum process control.
- **Heating from below: rapid and homogeneous**
The temperature-regulated two-zone infrared bottom heater provides rapid, yet precisely controlled warm-up at homogeneous substrate temperatures.
- **Streamlined technology**
The new WQB4000SOPS enables users to work with a standard PC via a USB 2.0 port. Additional appliances or interface cards are not required.
- **Monitoring software: comprehensive functions**
The monitoring software determines temperature profiles and facilitates definition of the optimal soldering process.
- **Teach-in feature: fast, effective parameter identification**
Repeatable results can only be achieved by a process cycle that considers all the parameters of the repair operation. The 'Teach-in' feature provides a quick and easy method of determining process cycle parameters and identifying critical points - without the need for in-depth operator knowledge. The software includes a library of soldering profiles, i.e. general and specific parameters enabling repeatable use. New profiles can be edited easily by the user and added to the library.
- **Perfect component/circuit board alignment**
With the split optic camera, live images of a component and a circuit board can be aligned independently of each other using the x, y and theta axis fine adjustment drives.
 1. Component size & theta axis
 2. Align y axis
 3. Align x axis
 4. Component aligned!
- **Removal (desoldering) of the defective component**
The ability to preheat the circuit board and a temperature/time controlled process are critical for good reflow of the solder joints. At the end of the reflow cycle, to avoid damage to the solder pads, a vacuum lift automatically removes the component from the board with minimum force and exact temperature control.
- **Cleaning of the circuit board**
Residual solder should be removed from the board with a desoldering iron or desolder wick. Residual contaminants can be removed with a suitable solvent spray.
- **Positioning of the new component**
The new WQB4000SOPS station's split optic camera placement system ensures precise positioning of a wide range of components - from BGA to fine pitch SMT.
- **Component soldering**
Reflow of the replaced component is essentially a repeat of the removal process, without the vacuum lift being initiated at the end of the profile. An extensive range of hot gas nozzles and adapters are available to cater for the many body sizes of BGA devices or QFP and PLCC packages.
- **Temperature profiling**
An eight-step temperature profile enables soldering and cooling that are perfectly tailored to specific requirements.
- **Split Optics for perfectly accurate positioning**
The new SOPS (Split Optic Positioning System) with the high-resolution 2 Mpix CMOS USB 2.0 camera enables accurate positioning of the components following desoldering. It works with a single camera and two-colour lighting for exact positioning. Superb image quality at high dynamics and very low image noise ensure precise, ergonomic component mounting.
- **An ever expanding field of applications**
The new WQB4000SOPS is optimally equipped to take on repair and rework in mobile communications, research and general BGA, QFP work. Specifically, with PBGA, CBGS, CCGA, CSP's, Micro BGA, QFN, PLCC, SOP and PGA components.
 1. Components without direct access to the solder joint
 2. Leaded components with external solder joints
 3. A wide variety of special modules.

Material No.	Shelf Pack
--------------	------------

T0053370699	1
-------------	---

Technical Data

Dimensions (L x W x H):
approx. 630 x 630 x 650 mm
Dynamic dimensions:
approx. 1030 x 630 x 650 mm
Power supply voltage: 230V, 50/60 Hz
Mains fuse: T10A
Power: 2300W
Top heater: 700W
Bottom heater:
large 1600W (260 x 260) mm
small 400W (120 x 120) mm
Compressed-air supply:
400-600 kPa purified, dry compressed air
Compressed-air converter:
vacuum 60 kPa
Temperature control:
infinitely variable 50°C - 400°C
control precision ± 10°C
Flow control:
infinitely variable 5-50 l/min.
Air consumption: 60-100 l/min. (4 bar)
Total weight: approx. 40kg



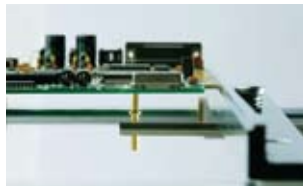

















Accessories for WQB4000SOPS



Description	Material No.	Shelf Pack	
Clamping Set/Irregular Board Holder for Circuit Boards • ROHS & WEEE Compliant	T0058754924	1	
Support for Large Sized Circuit Boards • ROHS & WEEE Compliant	T0058755745	1	
Thermocouple Type K, 0.5mm	T0053119099	1	
NQ Nozzle Adapter Adapter	T0058754970 T0058747770	1 1	
Vacuum Inserts - 4.5mm, 10pc • ROHS & WEEE Compliant	T0058713799	1	
Vacuum Inserts - 10mm, 10pc • ROHS & WEEE Compliant	T0058713798	1	
Temperature Sensor for Top Heater • ROHS & WEEE Compliant	T0058754948	1	
Circuit Board Block • ROHS & WEEE Compliant	T0058754873	1	
Serial Interface Cable • ROHS & WEEE Compliant	T0053119199	1	
Suppressing device for Circuit Boards • ROHS & WEEE Compliant	T0058755741	1	

Replacement Soldering Tips

PT SERIES Suit WTCPS/T stations and TC series soldering pencils.

	Description	Tip Size mm	Reach mm	Material No.			Shelf Pack	
				600°F (315°C)	700°F (371°C)	800°F (427°)		
	Screwdriver	1.6	15.9	PTA6	PTA7	PTA8	1	
	Single flat	1.6	15.9	PTAA6	PTAA7	PTAA8	1	
	Screwdriver	2.4	15.9		PTB7	PTB8	1	
	Single flat	2.4	15.9	PTBB6	PTBB7	PTBB8	1	
	Screwdriver	3.2	15.9	PTC6	PTC7	PTC8	1	
	Single flat	3.2	15.9		PTCC7	PTCC8	1	
	Screwdriver	4.7	15.9		PTD7	PTD8	1	
	Single flat	4.7	15.9		PTDD7		1	
	Screwdriver	6.0	15.9	PTE6		PTE8	1	
	Conical flat	1.2	15.9		PTF7	PTF8	1	
	Screwdriver	0.8	15.9	PTH6	PTH7	PTH8	1	
	Long Screwdriver	1.2	25.4		PTK7	PTK8	1	
	Long Screwdriver	2.0	25.4		PTL7	PTL8	1	
	Long Screwdriver	3.2	25.4		PTM7	PTM8	1	
	Long conical	0.8	25.4		PTO7	PTO8	1	
	Conical	0.8	15.9		PTP7	PTP8	1	
	Narrow Screwdriver	1.6	15.9	PTR6	PTR7	PTR8	1	
	Long conical	0.4	25.4	PTS6	PTS7	PTS8	1	
	Bent slotted	0.8	-	PTX6	PTX7	PTX8	1	
	Bent slotted	0.5	-	PTZ6	PTZ7		1	

Replacement Soldering Tips

ET SERIES

Suits EC1000/2000 WES50, WES51, WESD51 stations fitted with EC1201A, WSP50 and WSP51, PES50 & PES51 soldering pencils.

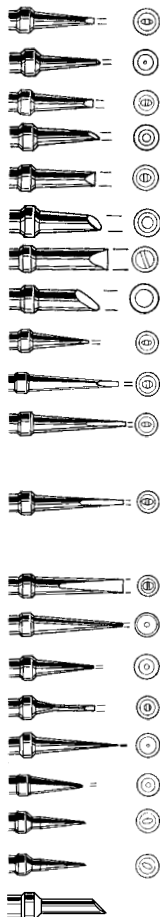

Description	Tip Size mm	Reach mm	Material No.	Shelf Pack
Screwdriver	1.6	15.9	ETA	1
Single flat	1.6	15.9	ETAA	1
Screwdriver	2.4	15.9	ETB	1
Single flat	2.4	15.9	ETBB	1
Screwdriver	3.2	15.9	ETC	1
Single flat	3.2	15.9	ETCC	1
Screwdriver	4.7	15.9	ETD	1
Single flat	4.7	15.9	ETDD	1
Screwdriver	0.8	15.9	ETH	1
Screwdriver	0.4	25.4	ETJB	1
Long Screwdriver	1.2	25.4	ETK	1
Knife Tip 45° Angle			ETKN	1
Long Screwdriver	2.0	25.4	ETL	1
Blunt			ETLB	1
Long Screwdriver	3.2	25.4	ETM	1
Long conical	0.8	25.4	ETO	1
Conical	0.8	15.9	ETP	1
Narrow Screwdriver	1.6	15.9	ETR	1
Long conical	0.4	25.4	TETS	1
Conical	0.6	15.9	ETT	1
Single flat	0.4	17.8	ETUB	1
Single flat	0.6	17.8	ETVX	1
Mini Wave for J Leads and Gullwings			ETGW	

EPH SERIES Suits EC3001 Stations/EC1301, EC1302A, EC1302B Soldering Pencils

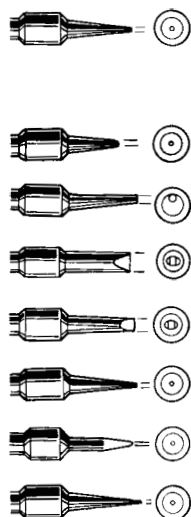

Description	Tip Size mm	Reach mm	Material No.	Shelf Pack
Micropoint	0.4	11.1	EPH101	1
Bent Conical	0.8		EPH102	1
Single flat	0.8	7.9	EPH103	1
Bent conical	1.2	11.1	EPH104	1
Screwdriver	1.6	11.1	EPH106	1
Chisel	2.0	11.1	TEPH107	1
Conical	0.8	11.1	EPH109	1
Conical	1.6	11.1	EPH110	1
Long micropoint	0.4	15.9	EPH112	1

Replacement Soldering Tips



LT Tip Selection Chart to suit WSP80/WP80

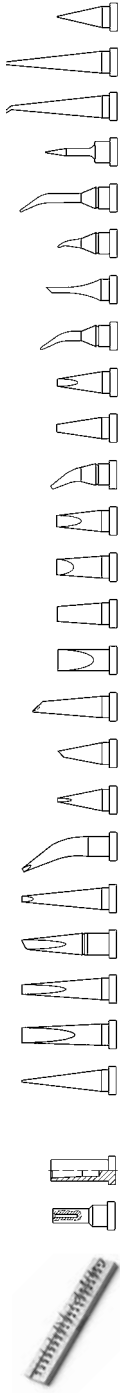

Material No.	Style	Size 1	Size 2	Reach	
LT1	Round	0.25	-	12.5	
LT1L	Round	0.2	-	25	
LT1LX	Bent Round	0.2	-	25	
LT1S	Round	0.2	-	15	
LT1SLX	Bent Round	0.4	-	20.5	
LT1X	Bent Round	0.4	-	20.5	
LT4AU	Single Flat	1.2	-	15	
LTA4X	Bent Chisel	1.2	0.16	16.5	
LTA	Chisel	1.6	0.2	12.5	
LTAS	Round	1.6	-	12.5	
LTAX	Bent Chisel	1.6	0.8	14	
LTB	Chisel	2.4	0.8	12.5	
LTC	Chisel	3.2	0.8	12.5	
LTCS	Round	3.2	-	12.5	
LTD	Chisel	4.6	0.8	12.5	
LTGW	Gull Wing	3.2	-	17.8	
LTF	Single Flat	1.2	-	12.5	
LTH	Chisel	0.8	0.4	12.5	
LTHX	Bent Chisel	0.6	0.2	20	
LTK	Chisel	1.2	0.4	20	
LTKN	Knife (J-Lead)	1.5	0.8	20	
LTL	Chisel	2.0	1.0	20	
LTM	Chisel	3.2	1.2	20	
LTS	Round	0.4	-	20	
NEW K111	Type K Thermocouple Weld, LTB				
T0054441799	LT Adapter				
T0054441600	Measuring/Calibration Tip				
T0054449599	LT Soldering Tip Set Contains 1 of each LT Tip - 40 Tips in convenient labelled stand				
NEW T0058744845	Short Barrel	40mm			
NEW T0058744846	Long Barrel	68mm			
NEW T0054448699	LTDD Soldering Tip	4.6mm			

Replacement Soldering Tips



NT Tip Selection Chart to suit WMP Pencil

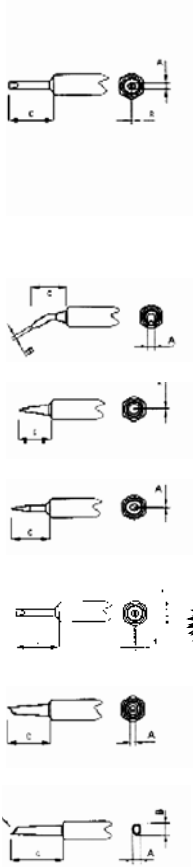
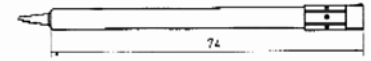

Description	Width A	Thickness B	Length C	Material No.
Chisel Tip	0.8mm	0.4mm	8.4mm	NTH
Chisel Tip	1.2mm	0.4mm	8.4mm	NTK
Chisel Tip	1.6mm	0.4mm	8.4mm	NTA
Chisel Tip	1.6mm	0.4mm	9.5mm	NT6
Chisel Tip	2.4mm	0.8mm	7.4mm	NTB
Chisel Tip	3.2mm	0.8mm	7.8mm	NTC
Chisel Tip	4.0mm	0.8mm	7.8mm	NTD
Chisel Tip, Bent	0.4mm	1.6mm	8.2mm	NTAX
Round Tip, Bent	1.6mm	0.8mm	8.6mm	NT1X
Round Tip	0.25mm	-	7.4mm	NT1
Round Tip, Small	0.25mm	-	8.5mm	NT1S
NEW Chisel Tip	0.4mm	0.14mm	8.4mm	NT1SC
Round Tip, Sloped 45°	1.2mm	-	9.9mm	NT4
Gull Wing	2.0mm	3.0mm	13.4mm	NTGW



RTW Tip Selection Chart to suit WMRT thermal tweezer

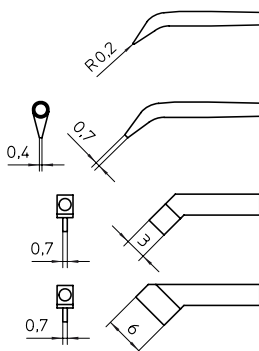

Cat No.	Dimensions			Style	Single product code	
	Width 1	Width 2	Length OA		Material No.	
RTW1	0.2mm			Tweezer tip	T0054465199	
RTW2	0.7mm			Tweezer tip	T0054465299	
RTW3	3mm			Tweezer tip	T0054465399	
RTW4	6mm			Tweezer tip	T0054465499	

Replacement Soldering Tips



WSP150 SERIES

Description	Tip Size mm	mm	Material No.	Shelf Pack
LHT-C Chisel Tip	3.2		T0054445599	1
LHT-D Chisel Tip	4.7	1.8	T0054445299	1
LHT-E Chisel Tip	6.7	1.8	T0054445199	1
LHT-F Chisel Tip	9.3	1.8	T0054445099	1
LHT Measuring Tip			T0054445399	1
LHTDX Bent Chisel Tip	5.0	2.0	T0054446200	1
LHTEX Bent Chisel Tip	7.0	2.0	T0054446100	1
LHTFX Bent Chisel Tip	10.0	2.0	T0054446000	1

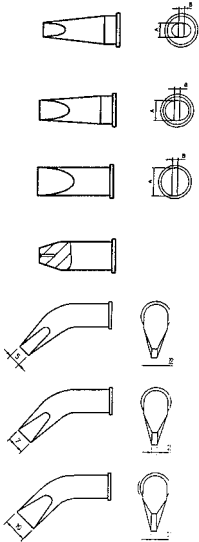

RT SERIES to suit WMRP pencil

Description	Tip Size mm	mm	Material No.	Shelf Pack
RT1 Needle Tip	0.2		T0054460199	1
RT1C Chisel Tip	0.4	0.15	T0054461299	1
RT2 Point Tip	0.8		T0054460299	1
RT3 Chisel Tip - Straight	1.3	0.4	T0054460399	1
RT4 Chisel Tip - 1.5mm thick	1.5	0.4	T0054460499	1
RT5 Chisel Tip, bent, 30°	0.8	0.4	T0054460599	1
RT6 Round Tip, bevelled, 45°	1.2		T0054460699	1
RT7 Knife Tip, sloped, 45°	2.2		T0054460799	1
RT8 Chisel Tip	2.2	0.4	T0054460899	1
RT9 Chisel Tip	0.8	0.4	T0054460999	1
RT10GW Gull Wing	1.2	2.0	T0054461099	1
RT11 Chisel Tip	3.6	0.9	T0054461199	1
RT Measuring Tip			T0054461399	1

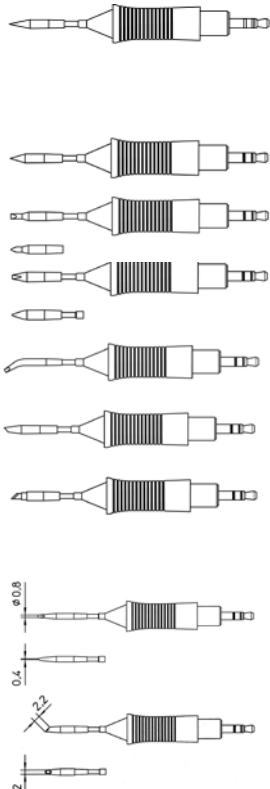

Replacement Soldering Tips

MT SERIES to suit MT1500D Soldering Station

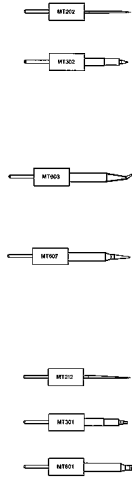

Description		Material No.	Shelf Pack	
Standard Tips Conical	Needle, .030 Calibration Tip	MT202	1	
	Conical Sharp, 0.16 x 530L	MT302	1	
	Conical Sharp, .020 x 530L	MT606	1	
Conical Bent	Conical Bent, 30 Deg. .015 x 320L	MT303	1	
	Conical Bent, 30 Deg. .020 x 600L	MT603	1	
	Conical Bent (Sharp) 30 Deg. .016 x 560L	*MT605	1	
Bevel	Bevel, 30 Deg., .020 Dia. x .580	MT607	1	
	Bevel, 30 Deg., .040 Dia. x .560	*MT608	1	
Screwdriver	Screwdriver, .045 W x .005 THK x 1.0L non wet	MT211	1	
	Screwdriver, .045 W x .005 THK x 1.0L non wet	MT212	1	
	Screwdriver, .047 x 200L	MT301	1	
	Screwdriver, .070 x 385L	MT601	1	
	Screwdriver, .100 x 390L	*MT602	1	
	Screwdriver, .200 x 350L	*MT610	1	
Surface Mount Tips PLCC'S	Quad PLCC-44, .70 SQ., Flex Leg	MT1203F	1	
	Quad PLCC-68, 1.000 SQ., Flex Leg	MT1208F	1	
	Quad PLCC-18, .335 x 535	*MT1212	1	
	Quad PLCC-28, .500 SQ.	*MT1201	1	
	Quad PLCC-32, .500 x 600	*MT1204	1	
SIP	SIP (Blade) .410L	MT617	1	
CHIP	CHIP 1206/1210, .135W x .070L	*MT618	1	
	CHIP SOT 23, 068W x .100L	*MT624	1	



XT SERIES to suit WP120 Soldering Pencil

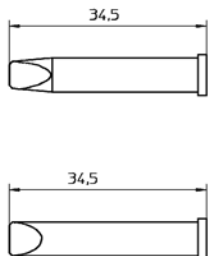

Description	Width mm	Height mm	Length mm	Material No.	Shelf Pack	
XTAL Chisel	1.6	1.0	39	T0054470199	1	
XTM Chisel	3.2	1.2	39	T0054470299	1	
XTA Chisel	1.6	0.7	36	T0054470399	1	
XTB Chisel	2.4	0.8	36	T0054470499	1	
XTC Chisel	3.2	0.8	36	T0054470599	1	
XTD Chisel	4.6	0.8	34.5	T0054470699	1	
XTE Chisel	5.9	1.2	34.5	T0054470799	1	

Replacement Soldering Tips

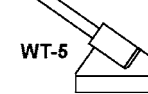
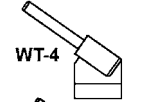
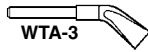
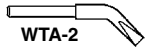
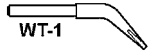

WT SERIES to suit WT-50 Thermal Tweezers

Strip Size	Tip Size mm	"x" mm		Material No.	Shelf Pack
0405-1805, SOD80, MELF	1.0	11.0	WTA-1	T0054414199	1pr
1808-1812, SOD87, SOT23, SOD89	3.0	11.0	WTA-2	T0054414699	1pr
SOT192, S04-S0	6.0	11.0	WTA-3	T0054414799	1pr
S014, S016, SOJ14, SOJ16	12.5	10.0	WTA-4	T0054414399	1pr
S020, S020L, SOJ20	18.5	12.0	WTA-5	T0054414499	1pr
VERTICAL USE	1.0		WTA-11	T0054415299	1pr
VERTICAL USE	3.0		WTA-12	T0054415399	1pr

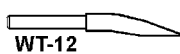
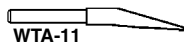

NOZZLES to suit QWB2000 and QWB3000

Nozzle Housing Inside mm x mm	Nozzle Housing Outside mm x mm	Material No.	Shelf Pack
7.6 x 7.9	8.6 x 8.9	T0058747947	1
6.5 x 6.5	7.5 x 7.5	T0058747943	1
8.5 x 8.5	9.5 x 9.5	T0058747945	1
8.5 x 10.6	9.5 x 11.6	T0058747961	1
10 x 10	11 x 11	T0058754967	1
12 x 12	13 x 13	T0058747848	1
13.5 x 13.5	14.3 x 14.3	T0058747904	1
15.5 x 15.5	16.5 x 16.5	T0058747935	1
15 x 11	16 x 12	T0058747893	1
18.5 x 10	19.5 x 11	T0058754836	1
15.5 x 23.5	16.5 x 24.5	T0058747977	1
18 x 18	20 x 20	T0058747833	1
21 x 21	23 x 23	T0058754770	1
22 x 22	24 x 24	T0058754820	1
25 x 25	27 x 27	T0058747764	1
27 x 23	29 x 25	T0058747993	1
27 x 27	29 x 29	T0058747850	1
29 x 29	31 x 31	T0058747927	1
28 x 32	30 x 34	T0058747999	1
33 x 33	35 x 35	T0058747906	1
35 x 35	37 x 37	T0058754887	1
37 x 37	39 x 39	T0058747753	1
39.5 x 39.5	41.5 x 41.5	T0058747871	1
42 x 42	44 x 44	T0058747874	1
45 x 11	47 x 13	T0058754903	1
45 x 26	47 x 28	T0058754905	1
46 x 46	48 x 48	T0058747763	1
47 x 47	49 x 49	T0058747916	1
49 x 49	51 x 51	T0058747941	1
57 x 18.5	59 x 20	T0058747985	1
55 x 45	57 x 47	T0058755749	1
Adaptor		T0058747770	1
Adaptor QFP Nozzles		T0058754970	1

Replacement Soldering Tips

WPT0 SERIES PYROPEN TIPS, Suit WSTA6 Auto Ignition Jr.

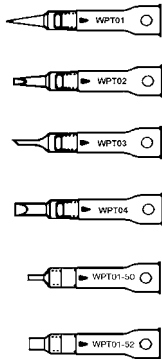

Description	Tip Size mm	Material No.	Shelf Pack
Taper	1.0	WPT01	1
Screwdriver	2.4	WPT02	1
Chisel	2.0	WPT03	1
Screwdriver	5.0	WPT04	1
Nozzle	1.5	WHC0150	1
Nozzle	4.7	WHC0152	1

WPT SERIES PYROPEN TIPS, Suit WST2 Junior

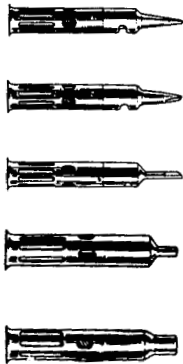

Description	Tip Size mm	Material No.	Shelf Pack
Tapered Needle	0.5	WPT15	1
Chisel	3.0	WPT16	1
Spade	3.0	WPT17	1
Hot Blow	1.5	WHC54	1
Hot Blow	4.9	WHC55	1

REPLACEMENT TIPS JUMBO PYROPEN WSTA5

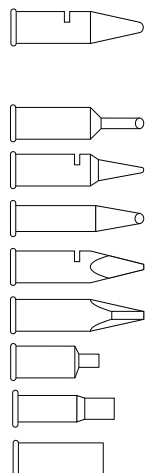

Description	Tip Size mm	Material No.	Shelf Pack
Conical	3mm	720101AU	1
Chisel	2mm	720102	1
Spade	4mm	720103	1
Conical	2mm	720105	1
Spade	4mm	720106	1
Pyramid	2mm	720107AU	1
Flat	3mm	720113	1
Hot Blow	4mm	720151	1
Hot Blow	6mm	720152	1
Hot Blow	10mm	720153	1
Small Heat Shrink		720154	1
Large Heat Shrink		720155	1

Replacement Soldering Tips

WPT SERIES PYROPEN TIPS, Suits WSTA3 and WPA2

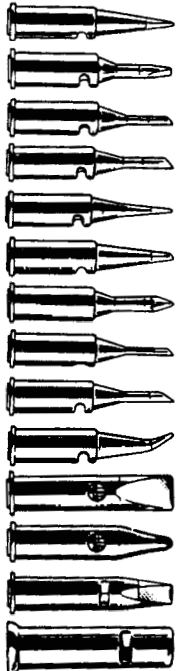

Description	Tip Size mm	Material No.	Shelf Pack
Taper	-	WPT1	1
Chisel	2.0	WPT2	1
Spade	2.0	WPT3	1
Spade 45°	3.0	WPT4	1
Taper Needle	-	WPT5	1
Micro Spade	2.0	WPT6	1
Square Taper Pyramid	0.5	WPT7	1
Spade 35°	2.0	WPT8	1
Spade 35°	3.0	WPT9	1
Offset Tapered Needle	1.0	WPT10	1
Chisel	8.0	WPT11	1
Round Head Needle	3.0	WPT12	1
Long Tapered Needle	5.0	WPT13	1
Threaded Tip Base	-	WPT14	1

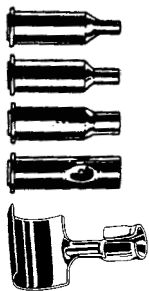

Hot Blow	2.5 ID	WHC50	1
Hot Blow	3.3 ID	WHC51	1
Hot Blow	4.9 ID	WHC52	1
Hot Blow	7.4 ID	WHC53	1
Heat Shrink Attachment Long		WAR54	1
Heat Shrink Attachment Small		WAR55	1

PSI SERIES PORTASOL TIPS Suit PSI-100 Irons

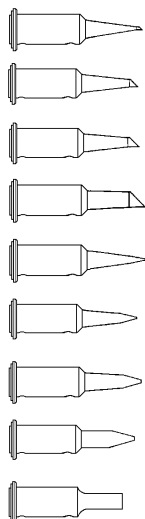

Description	Tip Size mm	Material No.	Shelf Pack
Single Flat	1.0	PSI1	1
Single Flat	2.4	PSI2	1
Single Flat	3.2	PSI3	1
Single Flat	4.8	PSI4	1
Single Flat	1.0	PSI5	1
Double Flat	2.4	PSI6	1
Double Flat	3.2	PSI7	1
Double Flat	4.8	PSI8	1
Hot Blow	-	PSI9	1
Hot Knife	-	PSI10	1

Replacement Desoldering Tips

DS SERIES TIPLETS Suit DS102, DS651, DS1201, Tools and DS650 Station/DS80UNC/DSV80

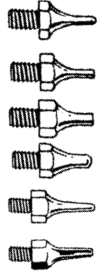

Description	mm	Tip Size mm	mm	Material No.	Shelf Pack
DS110	0.63	1.52	12.7	DS110	1
DS111	0.63			DS111	1
DS112	0.91	1.93	12.7	DS112	1
DS113	1.16	2.48	12.7	DS113	1
DS114	1.80	3.25	12.7	DS114	1
DS115	0.63			DS115	1
DS116	1.14	2.48	19.05	DS116	1
DS117	0.63	2.28	19.05	DS117	1
DS118				DS118	1

DSH SERIES TIPLETS Suit DS1203A Tools and WDD80V/DS80UNC/DSV80



Description	mm	Tip Size mm	mm	Material No.	Shelf Pack
DS119	0.63	2.48	19.05	T0051352700	1



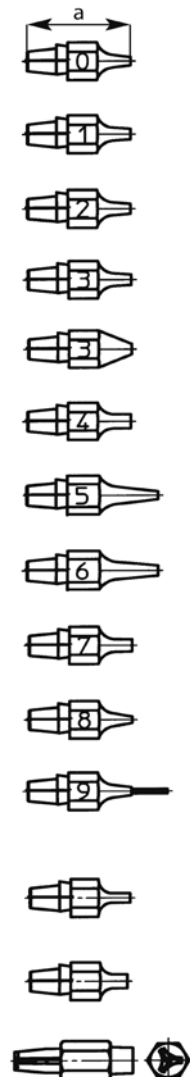





DSX SERIES CAM LOCK TIPS

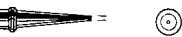



Description	Outside Ø	Inside Ø	Length a	Material No.	Shelf Pack
DX110 NOZZLE	1.9	0.7	23	T0051314000	1
DX111 NOZZLE	2.5	0.7	23	T0051314100	1
DX112 NOZZLE	2.3	1.0	23	T0051314200	1
DX113 NOZZLE	2.5	1.2	23	T0051314300	1
DX113HM NOZZLE with improved thermal transfer	2.5	1.2	23	T0051315000	1
DX114 NOZZLE	3.3	1.8	23	T0051314400	1
DX115 NOZZLE	1.9	0.7	27	T0054460199	1
DX116 NOZZLE	2.7	1.2	27	T0051314600	1
DX117 NOZZLE	2.9	1.5	23	T0051314700	1
DX118 NOZZLE	1.5	0.7	23	T0051314800	1
DX119 Needle tiplet with non wettable stainless steel tube for removal of solder bridges in connection with hot air pencil	1.1	0.7	31	T0051315100	1
DX120 NOZZLE without inside tube for cleaning SMD pads	2.5	1.1	22	T0051315200	1
DX MEASURING Measuring nozzle	3.3	0.55	21.5	T0051315399	1
DX Cleaning Tool (Conus insert cleaning tool)				T0058706794	1
Nozzle Set DX110-DX115				T0051379099	1

Replacement Soldering Tips

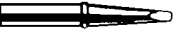
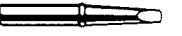

CT5 SERIES Suits W60D Soldering pencil

	Description	Tip Size mm	Reach mm	Material No.			Shelf Pack	
				600°F (315°C)	700°F (371°C)	800°F (427°C)		
	Screwdriver	1.6	29.36		CT5A7	CT5A8	1	
	Spade	1.6	19.00	CT5AA6	CT5AA7	CT5AA8	1	
	Screwdriver	2.4	29.36		CT5B7	CT5B8	1	
	Spade	2.4	19.00	CT5BB6	CT5BB7		1	
	Screwdriver	3.2	29.36	CT5C6	CT5C7	CT5C8	1	
	Spade	3.2	19.00	CT5CC6	CT5CC7	CT5CC8	1	
	Screwdriver	4.8	29.36		CT5D7	CT5D8	1	
	Spade	4.8	19.00		CT5DD7	CT5DD8	1	
	Screwdriver	6.35	29.36		CT5E7		1	
	Spade	6.35	19.00		CT5EE7		1	

CT6 SERIES Suits W100D Soldering pencils

	Screwdriver	3.18	37.3	CT6C6	CT6C7	CT6C8	1	
	Screwdriver	4.76	37.3	CT6D6	CT6D7		1	
	Screwdriver	6.35	37.3	CT6E6	CT6E7	CT6E8	1	
	Screwdriver	9.52	37.3	CT6F6	CT6F7	CT6F8	1	
	Welding Mirror (50 x 40 x 4) teflon coated				T0051176799			

CT2 SERIES Suits W201 Soldering Iron

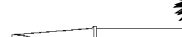
	Screwdriver (CT2E7, CT2E8)	7.0		-	T0054240799	T0054240899	1	
	Screwdriver (CT2F6, CT2F7, CT2F8)	10.0		-	T0054241799	T0054241899	1	
	Screwdriver (CT2G8)	11.0	425°		T0054242899		1	

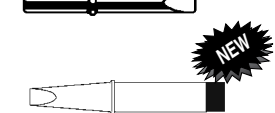

S.M.T. Soldering and Desoldering Accessories

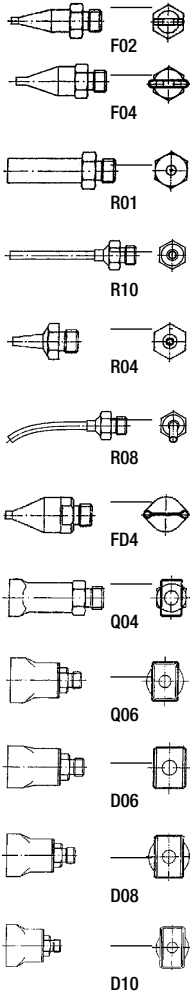

HOT AIR NOZZLES FOR HAP1 Hot Air Pencil

Description		Material No.	Shelf Pack	
F02	Flat Nozzle	8 x 1.5mm	T0058727774	1
F04	Flat Nozzle	10 x 1.5mm	T0058727773	1
F06	Flat Nozzle	12 x 1.5mm	T0058727772	1
R01	Calibrating Nozzle		T0058727808	1
R10	Straight Nozzle	2.5mm diam.	T0058727787	1
R02	Nozzle	0.8mm diam.	T0058727823	1
R04	Nozzle	1.2mm diam.	T0058727821	1
R06	Nozzle	3.0mm diam.	T0058727822	1
R08	Bent Nozzle	2.5mm diam.	T0058727786	1
FD2	Dual Nozzle	1.5mm diam. x 8mm	T0058727776	1
FD4	Dual Nozzle	1.5mm diam. x 10mm	T0058727775	1
Q02	Nozzle	6 x 6.5mm	T0058727777	1
Q04	Nozzle	6 x 9mm	T0058727778	1
Q06	Nozzle	15 x 10mm	T0058727780	1
Q08	Nozzle	12.5 x 15mm	T0058727783	1
Q10	Nozzle	18 x 18mm	T0058727785	1
D06	Nozzle	10 x 13mm	T0058727782	1
D08	Nozzle	15 x 10mm	T0058727781	1
D10	Nozzle	10 x 18mm	T0058727784	1

C.S.F. SERIES TIPPLETS suits most Weller desoldering tools

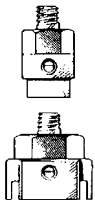

Description		Width x Length	Material No.	Shelf Pack
CSFD2	S0	5.8 x 10.5mm	CSFD2	1
CSFQ1	QFP	17 x 17mm	CSFQ1	1
CSFQ2	QFP	17 x 23mm	CSFQ2	1

Many NEW stock sizes available. Also adaptors to suit all Weller and some other brand desoldering tools.

S.M.T. Soldering and Desoldering Accessories



HOT AIR NOZZLES FOR WHA300/1000/2000 Stations

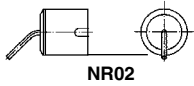

NR02

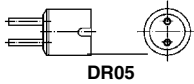

DR05

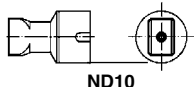

ND10

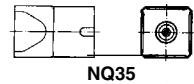

NQ35

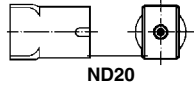

ND20

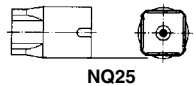

NQ25

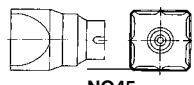

NQ45

Description	Material No.	Shelf Pack	
NR02	1.7mm diam. 45° bend. Hot blow only	T0058736882	1
NR04	2.5mm diam. straight. Hot blow only	T0058736881	1
DR05	2 x 2.5mm 9.5mm ctrs. Hot blow only	T0058736883	1
NR05	4mm diam. straight. Hot blow only	T0058736867	1
NR10	0.7mm	T0058736870	1
ND05	10.8 x 7mm S014, S016	T0058736843	1
ND10	14 x 10mm SOL14, SOL16, SOL16-J, SOL20, SOL-J20	T0058736842	1
ND15	19 x 12mm SOL24, SOL-J24, SOL-28, SOL-J28	T0058736841	1
ND20	21.5 x 14.8mm SOL 32	T0058736840	1
NQ05	10.7 x 10.7mm PLCC20, LCCC14, LCCC24, C-QFP24	T0058736839	1
NQ10	14.8 x 14.8mm PLCC28, QFP44, LCCC28, QFP48	T0058736818	1
NQ15	14.5 x 10mm PLCC32R	T0058736838	1
NQ20	15.5mm x 13mm	T0058736837	1
NQ25	18 x 18mm PLCC44, CLCC44, PQFP44, PQFP60, QFP64, QFP60, TSOP100, QFP100	T0058736814	1
NQ30	17.5 x 23.5mm QFP56, QFP60, QFP64, QFP80, QFP88, QFP100	T0058750721	1
NQ35	20.5 x 20.5mm PLCC52, BQFP84	T0058736807	1
NQ40	26 x 26mm C-QFP64, PLCC68, CLCC68	T0058736804	1
NQ45	31.3 x 31.3mm CLCC84, PLCC84, QFP100, QFP120, QFP128, QFP132, QFP136, QFP144, QFP160, C-QFP80, BQFP164, BQFP132, MQUAD208L, MQUAD184L, MQUAD144L, QFP208	T0058736833	1
NQ50	36 x 36mm QFP240	T0058736891	1
NQ55	43 x 43mm CQFP304	T0058736890	1
NA20	Measuring Nozzle	T0058736875	1

S.M.T. TIPPLETS suits WTCPS/T and EC Stations with EC1201 pencils WES50D and WSP80 Stations

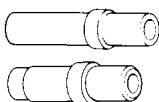
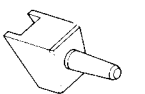
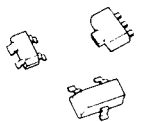
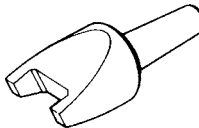
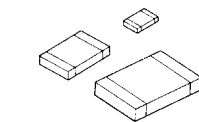

Description	Chip	Size	Material No.	Shelf Pack
	0705	1.8 x 1.3 x 1.0	SMT0805B	1
	0805	2.0 x 1.3 x 1.3	SMT0805B	1
Small Outline I.C.				
SMT8K	S08	5.0 x 4.0 x 1.7	SMT8K	1
Adaptors				
	SMTA (WSP80)		T0054441799	1

Fume Extraction

Many work environments today, including soldering, adhesives, welding and laser applications, create particles and gases that can be harmful to the work place and the environment. Most people thought that the move to lead-free soldering would be more nature friendly. In reality lead-free soldering smoke emissions contain more breathable fine dust particles. More and smaller particles are produced due to the higher working temperatures required and because more flux is used in the soldering process.

In many countries legal regulations governing clean air in the work place require that hazardous substances are removed from the air in order to avoid harmful effects on people and machines.

It is important to use the correct safety equipment to remove these hazardous substances. Fine particles are more dangerous to inhale than big particles as they get caught more easily and block the alveoli in the lungs.

To protect the operator it is important to use an extraction system that is able to separate these particles and gases and then re-circulates the cleaned air back into the work place. This saves energy and reduces energy costs.

Weller® Zero-Smog® Systems offer two solutions for fume extraction:

Tip Extraction

Weller® FE (Fume Extraction) soldering irons have a smoke tube integrated into the handle. When soldering the tube is positioned directly above the joint and collects any fumes produced. Fume extraction attachments can be retro fitted to non fume extraction Weller® soldering irons.

- Less investment per work place
- Collect pollution direct at source
- Up to 20 collection points with one system (200 m apart)
- Ergonomic friendly with easy access to work place
- No noise
- Minimal air movement

Tip Extraction



Volume Extraction

More suitable for applications involving, for example, solder baths, hot air soldering, micro solders and gluing work. Weller® offers various mobile systems that purify the air at up to a maximum of 8 workplaces.

- Larger areas can be covered
- Low maintenance
- Mobile
- Quick & easy installation
- Economic for 1 to 8 work places
- Remote control

Volume Extraction



Filter Technology

Weller® Zero-Smog® Systems are specifically designed for continuous operation in industrial environments. Care and attention at the design stage plus careful component choice and a high quality manufacturing process have given Weller® extraction systems a world wide reputation for reliability and longevity.

Weller® Zero-Smog® Systems have a **three stage filter system** for removing small particles, fumes and gases that are produced in different working processes:

1. The hazardous substances are efficiently captured by the nozzle and are absorbed into the filter.
2. Bigger particles get caught in the pre-filter and smaller particles get caught in the HEPA (High Efficiency Particulate Air) filter.
3. The Wide Band Gas Filter removes fumes and adhesives.

End product – clean air – is re-circulated into the workplace.

Filter Class	Recommended Application
F 5	for standard applications
F 7	for applications with high flux content
H12 / H13	filter for clean rooms 1000 – 100

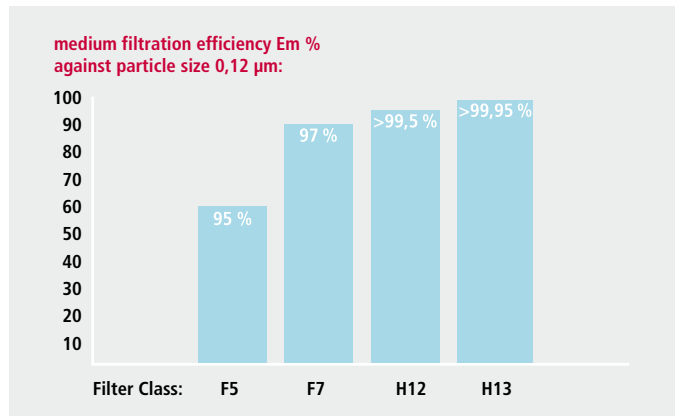
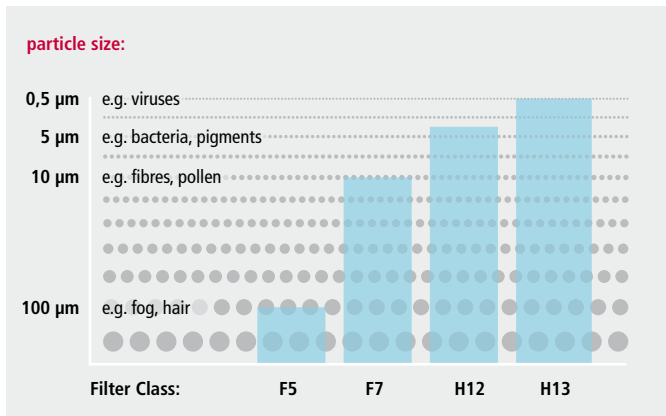

Filter Class F5, F7: Fine dust filter as per EN 779
Filter Class H12/H13: According EN 1822 HEPA (High Efficiency Particulate Air) Filter

Filter Process

WFE, WFE P

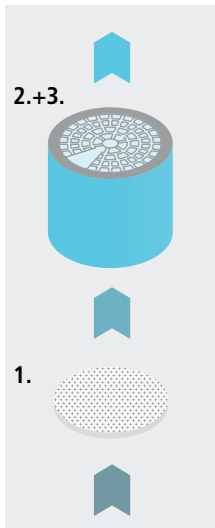

WFE 2X

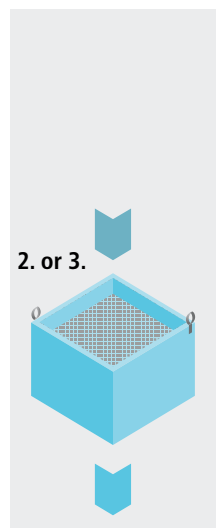

WFE 20D, WFE 2S,
WFE 4S, WFE 8S,
WFE 2ES, WFE 2CS

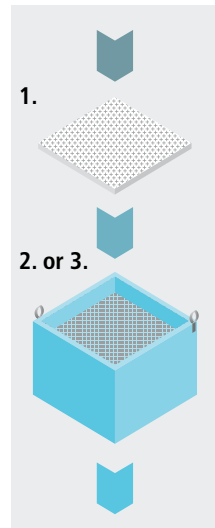

1. Fine dust filter

For standard applications with a small amount of flux and pollution gases with high solid content, Weller® offers filter classes **F5** or **F7**.

2. Compact filter consisting of: HEPA filter

Filters particles up to 0.3 µm. Weller offers HEPA (High Efficiency Particulate Air) filters of class **H12** and **H13**, medium filtration efficiency 99.5% / 99.95%.

Wide band gas filter

For cleaning harmful fumes and vapours. The Weller wide band gas filter consists of **50% active carbon** and **50% Puratex**. Harmful gases with a high molecular weight are cleaned by the active carbon. Puratex is suitable for absorbing gases of lower molecular weight. Because of its composition, Puratex is able to convert a large number of chemical pollutants by means of molecular modification into non-polluting gases.

3. Gas filter (option)

The gas filter is used for extracting adhesive fumes and solvents. Experience has shown that filtering suspended particles is not so vital in this respect. The gas filter is filled with **50% active carbon** and **50% Puratex**. The HEPA H12 and H13 is omitted.

Solder Fume Extracting Unit



ESD safe



low sound level

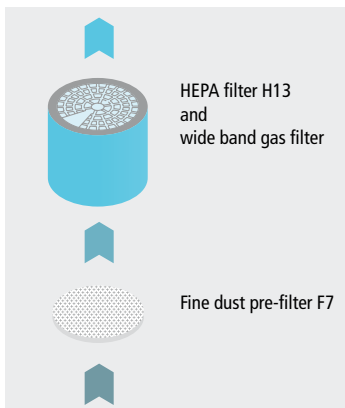

Description

WFEP2

The Weller® WFE P2 is a line voltage fume extraction unit designed to run with one or two FE (Fume Extraction) soldering irons. The WFE P2 has an electric, long-life, soundproofed vacuum pump to produce the required vacuum - it does not need a compressed air supply. The vacuum pump has two power settings which can be selected by means of rocker switches depending on the number of FE soldering irons connected to the unit. This saves energy. The motor is maintenance-free and has a thermal over load to protect the unit. The filter lift system allows fast and convenient main filter replacement. FE soldering irons are connected directly to unit - additional leads are not required.

- Up to 2 FE soldering irons can be connected
- Electric vacuum pump to produce the required vacuum
- 2 power stages for higher extraction performance with 2 FE soldering irons
- Portable unit for stand alone applications.

Scope of supply includes:

- WFE P Fume extraction unit
 - Compact filter
- Consists of: HEPA filter H13, wide band gas filter (50% active carbon, 50% Puratex)

Technical Data:

Maximum capacity 2 FE soldering irons
 Sound level <45 db (A) at 1m distance
 Operating voltage 230V/50Hz
 Power input 70W
 Maximum vacuum 30.000 Pa
 Height 295mm (11.6in)
 Diameter 140mm (5.5in)
 Weight 4kg/8.8lb

Material No.

T0053624599



Shelf Pack

1

Weller® WFE20D



ESD safe



low sound level

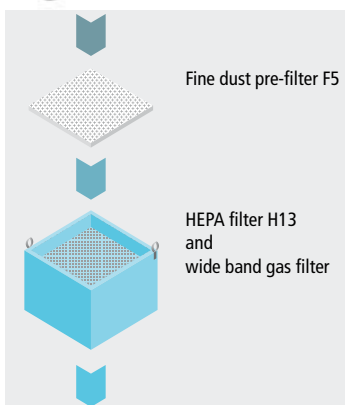

WFE20D

Solder fume extraction unit with built-in turbine for up to 20FE soldering irons

Consists of:

- Extraction Unit
- Fine Dust filter F7
- Compact filter
- Wide Band Gas filter (50% Active Carbon, 50% Puratex)
- ROHS & WEEE compliant

Material No.



1

WFE 20D Mobile Fume Extraction Unit

The WFE 20D has been designed for fume extraction direct from the soldering tip. Up to 5 Weller FE soldering irons can be connected directly. The capacity is 20 FE soldering irons with the optional DN 40 tubing system. The powerful maintenance free electronically controlled turbine provides a maximum vacuum of 12.000 Pa. The microprocessor also ensures detection of operating hours and the status of filter absorbcency. The three-stage filter system is suitable for use with soldering fumes. The filter system consists of a fine particulate air filter F5 and a combined submicron particulate air filter H13 plus wide band gas filter (50 % AKF, 50 % Puratex).

It removes 99,95 % of contaminants up to 0,12 µm according to EN 1822.

Characteristics:

- Two operating modes:
 Mode 0: Vacuum regulated to 12.000 Pa
 Mode 1: Extraction performance can be set between 20% - 100% with the control buttons.
- Electronic filter check (LED) through differential pressure measurement. If the specified degree of contamination is exceeded, the unit switches off.
- Electronic filter operation status display. For better management of filter change intervals - the filter operating hours can be pre-specified. The need for filter change is indicated in good time allowing adequate time for filter procurement and replacement. Interface RS 232 for remote monitoring or remote control.
- Remote control available as accessory.

Attributes:

- Up to 40 FE soldering irons can be connected
- Electric driven, maintenance free turbine produces the required vacuum
- 4 wheels to allow easy movement of the unit
- Mobile unit for central and stand alone applications
- Central installation for pipe systems up to 200 m (7874 in)

Technical Data:

Maximum capacity 40 FE soldering irons
 Sound level <51 db (A) at 1m distance
 Operating voltage 230V/50Hz 120V/60Hz
 Power input 630VA
 Maximum vacuum 12.000 Pa
 Max. delivery rate 100 m³/h
 Dimensions (L x W x H) 450 x 450 x 695 mm, 17.7 x 17.7 x 27.3 in
 Weight 45kg/99lb

Solder Fume Extraction Pencil Adaptors



Description	Material No.	Shelf Pack
TCP, TC201, EC1201A fume extraction pencil adaptor	AKFE11	1

FE (Fume Extraction) Soldering Irons



ESD safe

Description	Material No.	Shelf Pack
<p>The smoke absorption tube is integrated into the handle. It can be placed over the joint when soldering but can be retracted when access to the joint is a problem and can also be removed for cleaning. The irons are temperature controlled, ergonomic and allow precise handling. These electronically controlled irons can be driven from any Weller® power unit compatible with the rating of the iron or any Weller® rework station. The range of iron power ratings and the extensive range of solder tips mean that there is an iron to suit all applications. The FE soldering irons are supplied with a burn proof hose 5mm (0.19 in) diameter, 2.5m (98.42 in) long.</p> <p>FE ATTACHMENTS A range of FE attachments are available to fit standard Weller® soldering and desoldering irons to convert them to fume extraction versions. The attachments are supplied with all necessary fittings and hoses. The performance of the retro-fitted tools if not affected. For Weller® soldering irons WP120, WP80, WSP80, WMP, MLR21 or soldering irons with handle diameter 10-13mm (0.39-0.51 in). Clip will be fixed with an silicone O-ring to the soldering iron.</p> <p>FE Attachment with tube, 6.0mm for WP120, WSP80, WP80, MLR21, MLR80, WMP</p> <p>FE Attachment with tube, 4.5mm for WP120, WMRP and WSP80, WP80, MLR21, MLR80, WMP for fine soldering applications</p> <p>FE Spare Clip-Set for FE attachment, tube 4.5mm (0.17 in)</p> <p>FE Spare Clip-Set for FE attachment, tube 6.0mm (0.23 in)</p>		
	T0052918699	1
	T0052918599	1
	T0058744875	1
	T0058744876	1

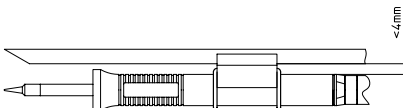

Weller® WFE2X



ESD safe



low sound level

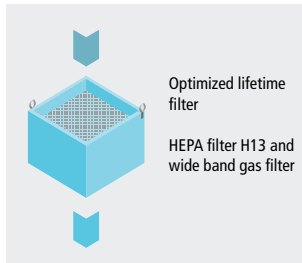

Optimized lifetime filter

HEPA filter H13 and wide band gas filter



Description	Material No.	Shelf Pack
<p>WFE2X Mobile fume extraction unit purifies air up to two workplaces. The WFE2X is a fume extraction unit and is suitable for applications with a high demand for gas and particle filtration, e.g. soldering, adhesives, clean room work and laser. It can be placed on a trolley and be moved easily between different work places. Variable speed and the alarm function for filter exchange can be set via the remote control. For applications which produce a large quantity of particles, e.g. lead-free soldering, an external pre-filter can be fitted to increase the lifetime of the main filter. To make installation easier, the WFE2X can be suspended under the work table with special fittings. An RS 232 interface makes it possible to integrate the software with other process equipment.</p> <p>Technical Data: Maximum capacity 2 work places Maximum extraction rate 140 m³/h Sound level <52 db (A) at 1m distance Operating voltage 100-240V/50/60Hz Power input 100W Maximum vacuum 2.300 Pa Dimensions (L x W x H) 210 x 460 x 660 mm 8.3 x 18.1 x 26 in Weight 15kg/33lb</p>	<p>WFE2XAU</p> 	1
<p>WFE2X KIT 1 Mobile fume extraction kit Includes:</p> <ul style="list-style-type: none"> • 2X Fume extraction unit 100-240V / 50/60Hz • KIT 1 WF60 Sloped stativ extraction arm for volume extraction consists of: <ul style="list-style-type: none"> Stativ extraction arm Funnel nozzle Stop valve Bench mounting bracket Extraction hose 	WFE2XKIT1AU	1

Weller® WFE2S



ESD safe



low sound level

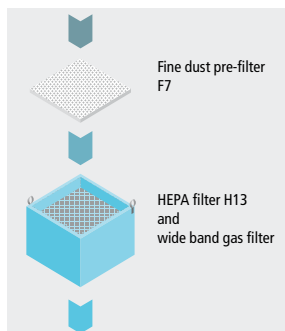



Description	Material No.	Shelf Pack
<p>WFE2S The fume extraction unit WFE2S is easy to install and operate. It is designed as a smaller, central system and is supplied complete with flexible hose, arm and bracket, ready for installation at the workplace. A powerful, maintenance-free pump provides continuous fume extraction at a maximum air extraction rate of 230m³/h. A built-in microprocessor controls the adjustable pump speed avoiding unnecessary waste of suction power and saving energy. To optimize the degree of pollutant separation, the WFE2S can be modified with filters for different applications.</p> <p>Technical Data: Maximum capacity 2 work places Maximum extraction rate 230 m³/h Sound level 48 db (A) at 1m distance Standard connection pipe system 50 Operating voltage 120/230V / 50/60Hz Power input 275VA Maximum vacuum 2.700 Pa Dimensions (L x W x H) 320 x 320 x 395 mm 12.6 x 12.6 x 15.5 in Weight 19kg / 41.8lb</p>	<p>T0053626699</p> 	1
<p>Fine main air filter (10 pack)</p>	T0058735885	1
<p>Main filter cartridge consists of:</p> <ul style="list-style-type: none"> • Submicron particulate air filter (H13) • Wide band gas filter (50% active carbon, 50% Puratex) 	T0058735883	1

Weller® WFE2 Kits



- WFE2 KIT 1**
One Workplace
- 1 Fume extraction unit WFE2S
 - 1 Extraction arm with nozzle WFAN 50, flexible, 50 mm diameter
 - 1 Table-mounting set WFTB 50
 - 1 Seal WFFMP 50
 - 1 Flexible hose NW 50 (3 m)

- WFE2 KIT 2**
Two Workplaces
- 1 Fume extraction unit WFE2S
 - 2 Extraction arms with nozzle WFAN 50, flexible, 50 mm diameter
 - 2 Table-mounting sets WFTB 50
 - 2 Seals WFFMP 50
 - 2 Flexible hoses NW 50 (3 m)
 - ROHS & WEEE compliant

<p>T0053643699</p> 	1
<p>T0053645699</p> 	1

WFE2 KIT 1



WFE2 KIT 2



Weller® WFE4S



Technical Data WFE 4S:

Dimensions	450 x 450 x 650 mm (L x W x H)
Weight	21 kg
Mains	230V / 50Hz
Power Absorption	450VA
Sound Level	51 db(A)
Max. Vacuum	2.800 Pa
Max. Conveyance	615 m ³ /h
Max. Capacity	Max. 6 work places
Standard connector	DN 70
Operating modes	3 operating modes (Normal-/ ECO-/ Regemode)
LED	LED for filter control
Remote control	RS 232 interface for remote control

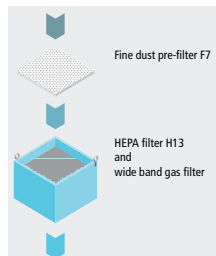

Description	Material No.	Shelf Pack
WFE4S The Weller WFE4S fume extraction unit provides volume extraction capability for up to 6 work places. A powerful maintenance free variable speed motor provides an airflow rate of 615m ³ /h at max speed. A built-in microprocessor controls the adjustable speed of the turbine. The airflow rate is continuously displayed digitally. The microprocessor also ensures detection of operating hours and the level status of filter absorbency. The three-stage filter is fitted as standard and is easy to replace, consisting of a fine particulate air filter and combined submicron particulate air filter + wide band gas filter. The WFE 4S centralized system is supplied complete with one pipe connector (three optional) and is easily connected to the pipe system. A wide range of pipe accessories including arms with conical nozzle, flat nozzle small vent, extraction hood and tray provide for maximum flexibility. • ROHS & WEEE compliant	T0053625699 	1
F5 Fine particulate air filter (10 pack)	T0058735837 	1
F7 Fine main air filter (10 pack)	T0058735836 	1
H13 + Wide Band Gas Filter (50% Active Carbon, 50% Puratex)	T0058735838 	1
Adhesive Fumes Filter + Wide Band Gas Filter (50% Active Carbon, 50% Puratex)	T0058735835	1
Pre-filter box The pre-filter is recommended for use with solder bath, automatic soldering, laser or other major dust emitting applications. It acts as a first stage in the filter process increasing the lifetime of the main filter units. The pre-filter can be fixed directly to the top of the WFE4S or in conjunction with the WFE2S and WFE2X as an external part of the fume extraction system. • Filter box • 2 x hose connections 75 Filters must be ordered separately	T0058735862 	1

Weller® WFE2ES Kit

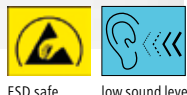

WFE2ES ES KIT

- Economy 2 Port Volume Extraction Unit
- Up to Maximum 2 Work Stations
 - Brushless EC Extractor Fan
 - Maximum Airflow 200m³/h
 - Maximum Vacuum 1800Pa
 - F5 Pre-Filter
 - H12 Main Filter (Activated Carbon Foam)
 - Low Noise Level

WFE2ES KIT

- 1 Workstation Kit
- 1 x WFE2ES
 - 1 x Extraction Arm
 - 1 x Table Mount Kit
 - 1 x Length Hose

T0053650599	1
T0053651699	1

Exploding Drawing for WFE2P

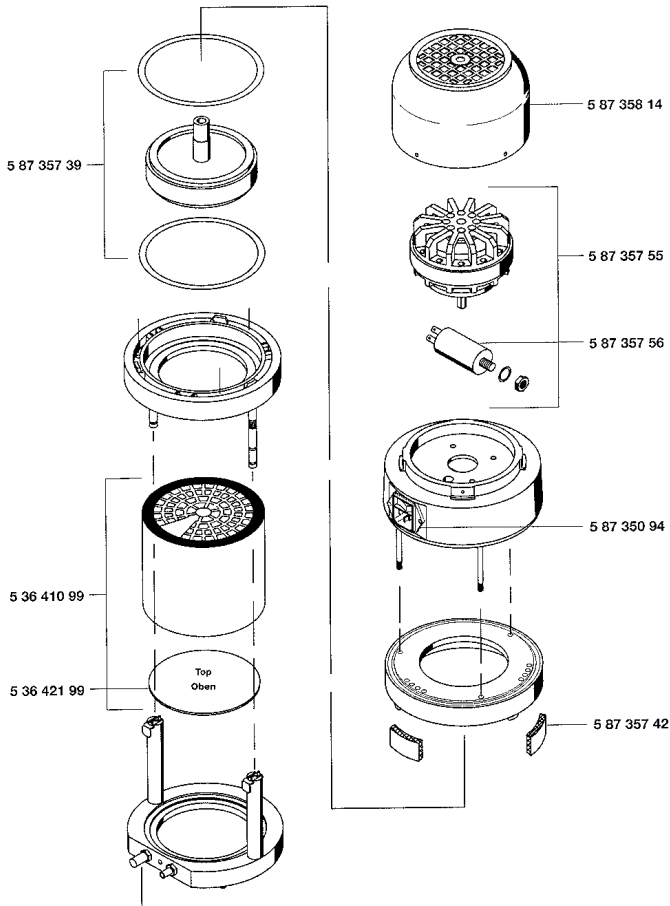

Installation Option for a Central System with WFE P

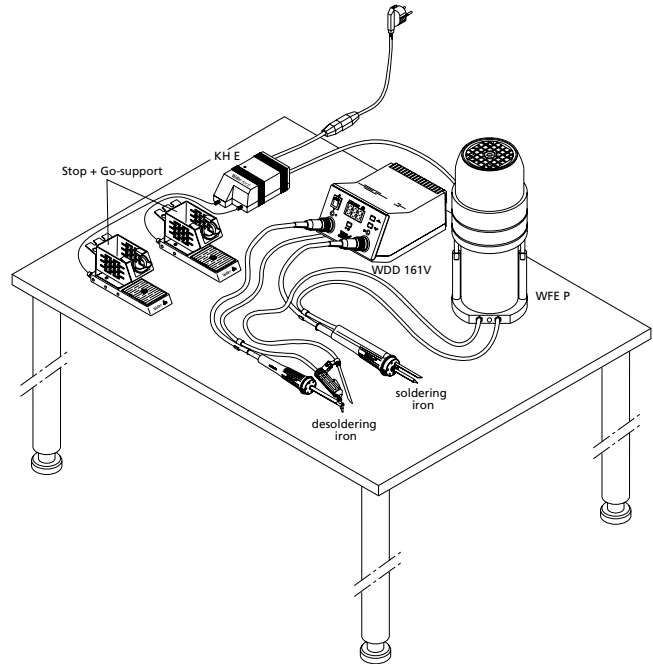

Installation Option for a Central and Stand Alone System with WFE 20D

central system

stand alone system with pipe system 50 upto ca. 200 m

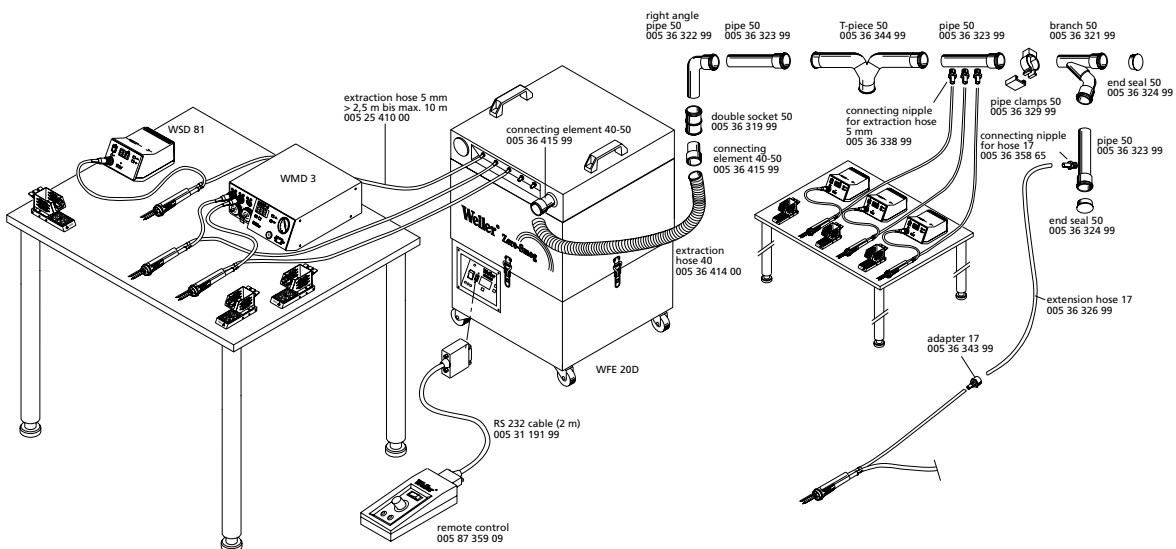

Installation Option for a Central System with WFE 2S

Total pipe length 15m

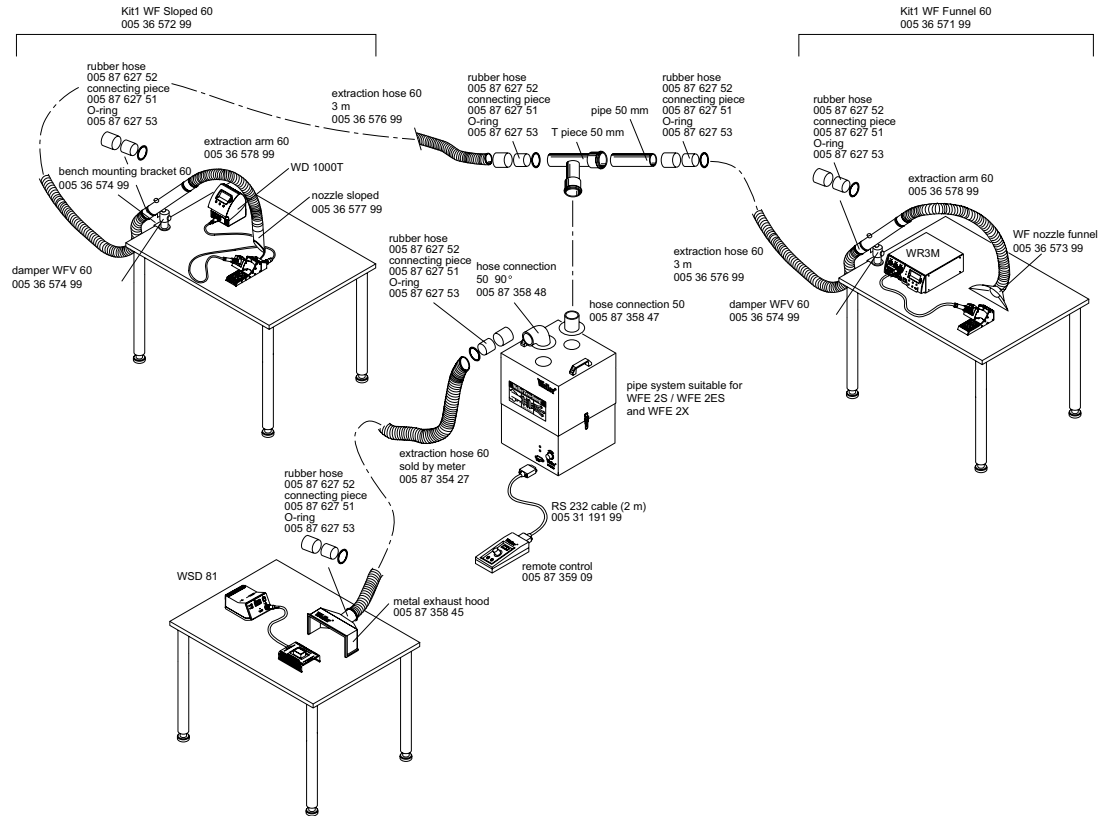

Installation Option for a Central and Stand Alone System with WFE 4S

Total pipe length 30m

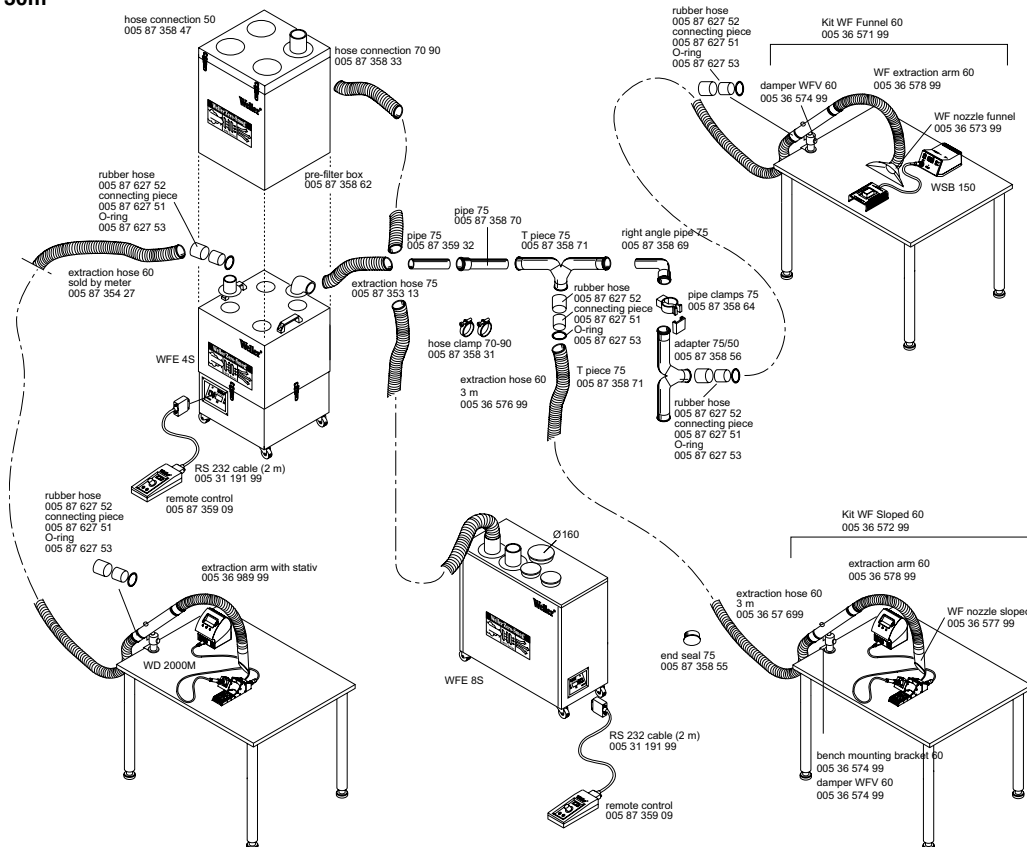

Accessories for Pipe System 50 and Pipe System 75 Tubing Systems

	Description	Material No.	
		P/code SYS50	P/code SYS75
	2m tube with socket	T0053632399	58735870
	90° bow with socket	T0053632299	58735869
	T-distributor 2 x 90° bow with socket	T0053634499	58735871
	2 x 45° bow with socket	T0053632199	Not Applicable
	Double socket	T0053631999	58735318
	Tube end cap	T0053632499	58735855
	Tube clamp DN50	T0053632999	
	Tube clamp DN75		58735864

Tube Reductions



Reduction from SYS75 to SYS50 with seals

T0058735863

Reduction from SYS75 to SYS50 without seals

T0058735856

Exhaust Assembly



DN100 90° bow with socket for WFE10 and WFE35

T0053635399

2m breather tube 100mm without seal for WFE20D and WFE4S

T0053631599

Exhaust flange for DN100 tube (only for use with WFE10)

T0058735919

Exhaust flange for DN100 tube (only for use with WFE4S)

T0058735840

Exhaust Adaptor 75 for WFE25

T0058735920















Accessories for Tip Suction



Description	Material No.	
	P/code 50mm	P/code 75mm
Extraction Hose, 1m. 40mm DIA. Complete with two connecting ones for direct connection to WFE20D	T0053631699	
Extraction Hose, 40mm DIA. Sold by the metre.	T0053641400	
Extraction Hose, 60mm (2.36 in), for connection to pipe system 50. 3m (118.11 in). Plastic, grey/black, flexible.	T0053657699	
Extraction Hose, 60mm (2.36 in), for connection to pipe system 50. Sold by metre. Plastic, grey/black, flexible.	T0058735427	
Connection Cone for Extraction Hose	T0053641599	
17mm DIA x 5m Extension Hose. Used where fume extraction iron is further than 2.5m from pipe system.	T0053632699	
Adaptor from DN17 to 5mm suction hose (M8 x 1)	T0053634399	
Hose Connector for Hose 5mm (M8 x 1)	T0053633899	
Connection Nipple	T0058735865	
3/8" Nut	T0058735866	
Suction flange for WFE2S and WFE4S	T0058735832	T0058735832
Suction flange 90° for WFE2S and WFE4S	T0058735847	5873583
Hose NW50 for DN40 tube system (metre goods)	T0058735327	
Hose NW75 for DN70 tube system (metre goods)		T005873531
Hose clamp (2 pieces) 50-70mm for hose NW50 Hose clamp (2 pieces) 70-90mm for hose NW75	T005735879	T0058735831

Accessories for Tip Suction

The following products are suitable for 50mm Diameter. When using a 75mm Diameter Hose, a tube reducer will be required (see page 46)

Description	Material No.	
 <p>Extraction table, active surface 600 x 350mm connectable from sides or below for tube system DN40, especially for the extraction of diagreeable solvent or adhesive smells.</p>	T0053637099	
 <p>Metal table extraction hood 200 x 100mm connectable to the DN40 tube system. Suitable for the extraction of solder fume in hot air applications or for work at small circuit boards.</p>	T0058735845	
 <p>One joint extraction arm, flexible, for bench assembly Ø 50mm, includes clamp holder, air flow adjustable, ESD Safe</p>	T0058735849	
 <p>NEW Stativ extraction arm, 60mm diameter, flexible extraction arm with articulated joint and airflow control valve and bench clamp. ESD Safe</p>	T0053659899	
 <p>WFAN 50 Extraction arm Ø 50 mm, flexible, with nozzle Ø 50 mm, ESD safe, needs WFFMP 50 seal</p>	T0053637499	
 <p>WFAF 50 Extraction arm Ø 50 mm, flexible, with slot 210 x 20 mm, ESD safe, needs WFFMP 50 seal</p>	T0053637299	
 <p>WFAS 50 Extraction arm Ø 50 mm, flexible, with slot 210 x 20 mm, ESD safe, needs WFFMP 50 seal</p>	T0053637399	
 <p>NEW Flexible Extraction arm, 60mm (2.36 in) diameter, for sloped and funnel nozzles. Maximum length 1m (39.37 in), ESD Safe</p>	T0053657899	
 <p>NEW WF60 sloped nozzle, 60mm diameter, for flexible and stativ extraction arm.</p>	T0053657799	
<p>Extraction arm, can be mounted directly to work bench, ESD Safe</p>	T0053634899	
<p>Extraction arm, flexible, ESD Safe, metal black</p>	T0058735853	
 <p>WFDD50 Extraction Plate</p>	T0053638099	
 <p>WFCC50 Exhaust Head</p>	T0053637899	
 <p>NEW WF funnel nozzle 60, for flexible and stativ extraction arm, 100mm (3.93 in) diameter.</p>	T0053657399	

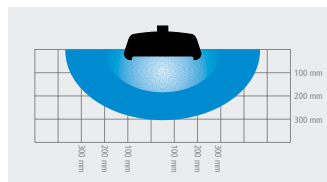

Accessories for Tip Suction

The following products are suitable for 50mm Diameter. When using a 75mm Diameter Hose, a tube reducer will be required (see page 42)



Description	Material No.
Extraction hood PE transparent, 296 x 248 mm (11.65 x 9.75 in)	T0053634999
WFFMP 50 seal, locking adjustable	T0053637199
WFTB 50 Table mounting set	T0053637999
Bench mounting bracket. Maximum width of clamp 100mm (3.93 in). 100mm (3.93 in) in diameter. Metal, black.	T0053657599
WFV 60 Stop valve. Table connector for 60mm (2.36 in) flex arm and extraction tube including air flow valve.	T0053657499
60/50 Adapter for applications using the 60mm (2.36 in) extraction system connected to the former WFTB50 and WFFMP50.	T0058762750
Hanging device for table mounting for fume extraction unit WFE2X.	T0053659199
Trolley for fume extraction unit WFE2X.	T0053659299
Remote control for tip and volume extraction units	
Remote control for fume extraction units WFE20D, WFE2S, WFE4S and WFE8S. Switching unit on/off, speed setting (only WFE2S/WFE4S), filter status display. Remote control for fume extraction unit WFE2X with 2m (78.74 in) cable.	T0058735909
Interface cable RS 232, 2m (78.74 in) for remote monitoring by PC (type 1:1).	T0053659399 T0053119199

Spare Part Filters

Spare filter for WFE8S:

Replacement pre-filter
Replacement compact filter (4 pieces in one pack) Consists of: HEPA filter H13, wide band gas filter (50% active carbon, 50% Puratex)

T0053659499
T0053659599

Spare filter for WFE2X:

Replacement compact filter
Consists of: HEPA filter H13, wide band gas filter (50% active carbon, 50% Puratex)

T0053659099

Spare filter for WFE4S:

Fine dust filter F5 (10 pieces)
Fine dust filter F7 (10 pieces)
Compact filter
Consists of: HEPA filter H13, wide band gas filter (50% active carbon, 50% Puratex)
Option: Adhesive fume filter (50% active carbon, 50% Puratex)

T0058735837
T0058735836
T0058735838

T0058735835

Spare filter for WFE2S:

Fine dust filter F5 (10 pieces)
Fine dust filter F7 (10 pieces)
Compact filter
Consists of: HEPA filter H13, wide band gas filter (50% active carbon, 50% Puratex)
Option: Adhesive fume filter (50% active carbon, 50% Puratex)

T0058735884
T0058735885
T0058735883

T0058735895

Spare filter for WFE2ES:

Fine dust filter F5 (10 pieces)
Compact filter Consists of: HEPA filter H12, wide band gas filter (10% active carbonate foam)

T0058762701

Spare filter WFE2S/WFE4S:

Filtering ash F7 for large quantities of dust
Filtering fine dust for sticky of arrears (e.g. large quantities of liquid flux)

T0058735860
T0058735924