

Single phase, non-stabilised dc power supply **DCT 24-2,5**

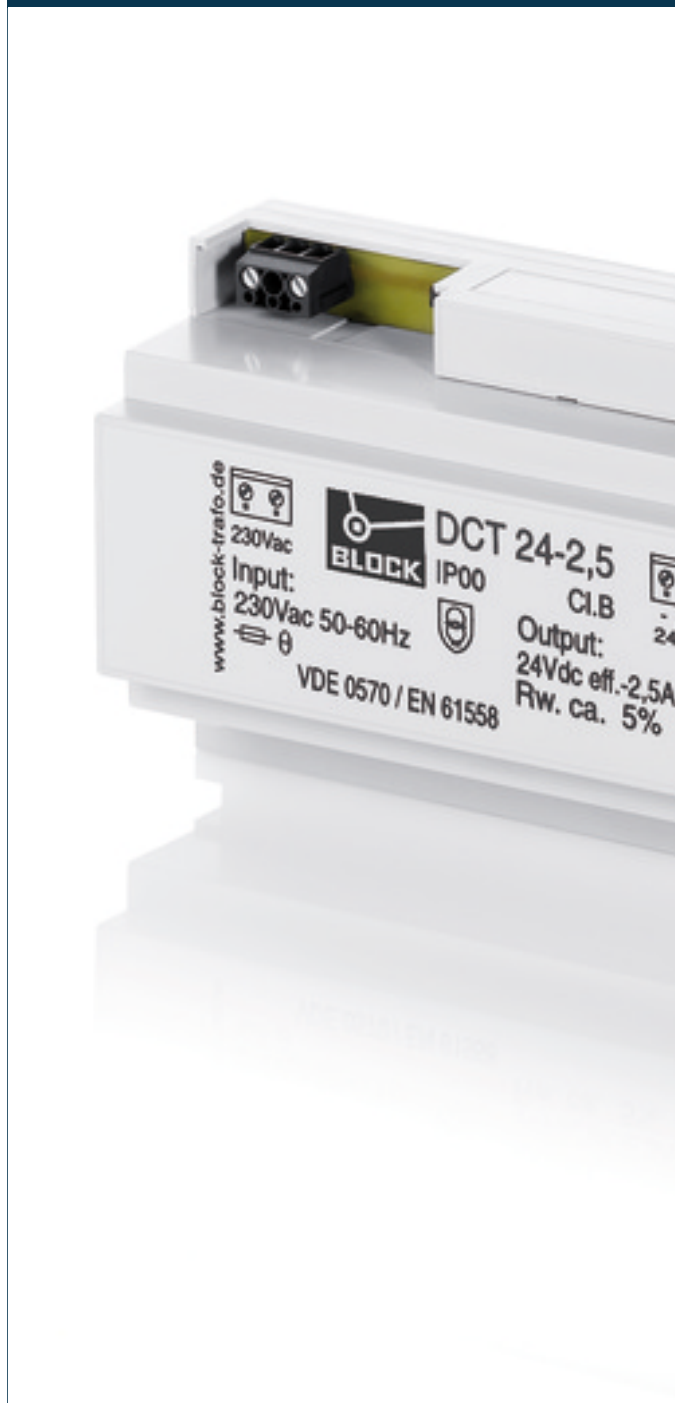

Advantages

Thermal cutout in the input and a fuse protection for the output

Separate windings

Capacitor accessories

Permanent corrosion protection, high insulation value and maximum electrical reliability thanks to XtraDensiFill resin encapsulation

Stable plastic housing for rail mounting, e.g. in consumer units or meter mounting boards

Applications

Robust direct current power is concentrated on the core task of voltage and power supply. Flat step profile optimized for installation in control panels in building automation.

Standards



Non-stabilised dc power supply / Safety isolating transformer to VDE 0570 part 2-6, EN 61558-2-6, IEC 61558-2-6

Approvals



Single phase, non-stabilised dc power supply

DCT 24-2,5

Electrical data	
Type	DCT 24-2,5
Input	
Input rated voltage	230 Vac
Rated frequency	50 - 60 Hz
Output	
Output rated voltage	24 Vdc
Power	60.00 W
Output rated current	2.50 A
Ripple factor	#5 %
Standards	
Classification	Single phase non-stabilised dc power supply / safety isolating transformer
Environment	
Cooling method	by self cooling
Ambient temperature max.	25° C
Safety and protection	
Type	Resin encapsulated transformer
Class of Insulation System	B
Protection index	IP 00
Safety class (prepared)	II
Short circuit strength	short-circuit proof
Order numbers	
Order Number	DCT 24-2,5

Mechanical data	
Type	DCT 24-2,5
Terminal and mounting	
Terminals	Screw-type terminals
Fixing method	DIN Rail system TH 35
Measures and weights	
Weight	1.93 kg

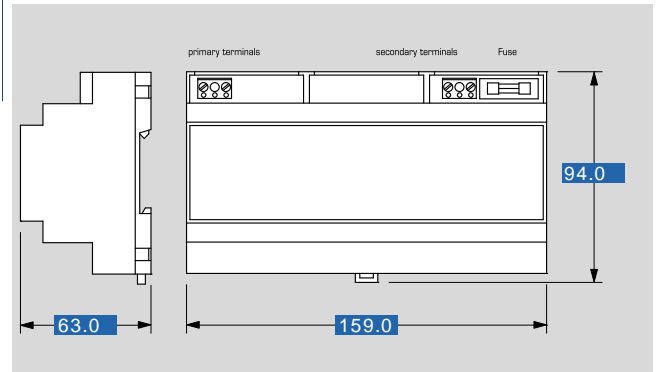

Subjects to change.