

DF60 Series

65A 10.16mm pitch Wire-to-Board Connectors for Internal Power Supply (UL, C-UL, TÜV Certified)



Power Supply



Positive-Lock



Compact



May.1.2023 Copyright 2023 HIROSE ELECTRIC CO., LTD. All Rights Reserved.



Features

1. Rated for up to 65A

DF60 has the capacity to handle a Max. of 65A when using 8 AWG wire with the single position connector. (Please refer to the chart for the rated current in other pin counts.)

2. Secure Lock Design Ensures Complete Mating

The locking design delivers a clear and tactile click, which prevents incomplete mating and reduces burden on workers for improved work efficiency.

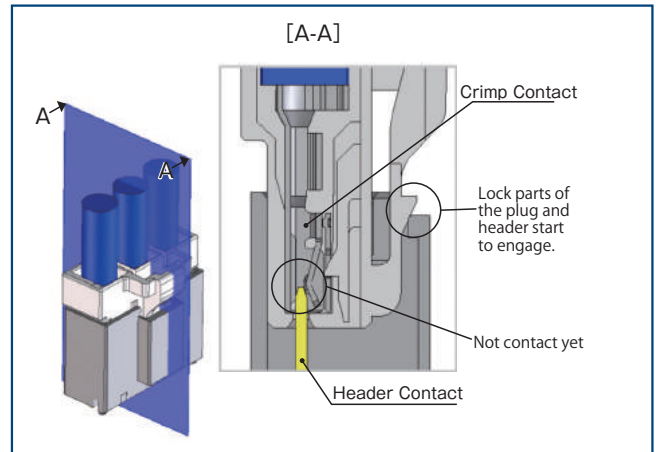

Lock Design

3. Highly Reliable 5-Points Contact Design

Three independent contact springs provide a secure and high contact reliability using 5-Points contact.

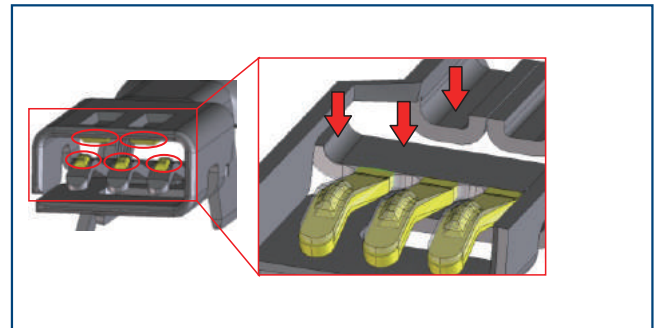

5-Points Contact

4. Molded Lance Design

The lance is actually part of the housing instead of being part of the terminal. This prevents tangled wires during assembly.

5. Reverse Mounting Prevention to PCB

The addition of a molded pin on the header allows temporary mounting retention and prevents reverse mounting on the PCB. (Right angle pin header has a metal fitting for this purpose.)

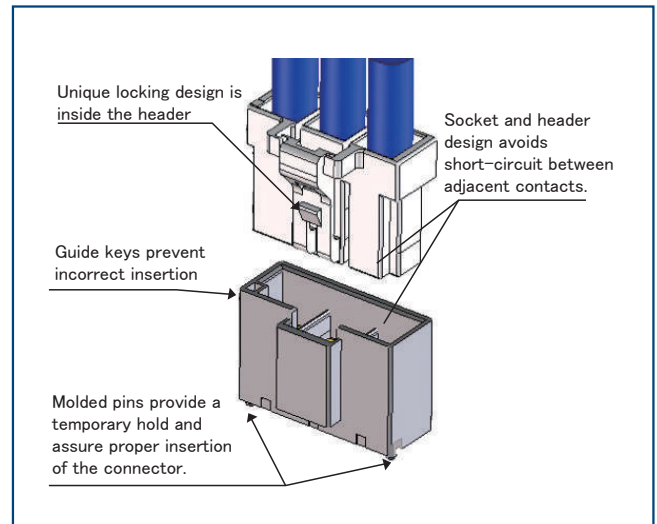

6. Short-Circuit Prevention

The wall design between the contacts helps to isolate the contacts and prevent short circuits between contacts.

7. Solder Crack Prevention

Glass-reinforced resin is used on the pin header to prevent solder cracks due to thermal contraction.

8. UL, C-UL and TÜV Specifications Certified

9. Glow Wire Compliant (Compliant with IEC 60695-2-11)

10. Finger-Safe (Electric Shock Prevention) Type Available

Product Specifications

Rated Current (Note 1)	No. of Pos.	8 AWG	10 AWG	12 AWG	Operating Temperature	-55 to +105°C (Note 2)	
	1	50A / pin	40A / pin	31A / pin	Storage Temperature	-10 to 60°C (Note 3)	
	2	42A / pin	35A / pin	28A / pin	Operating Humidity Range	20 to 80%	
	3		34A / pin		Storage Humidity Range	40 to 70% (Note 3)	
	4		33A / pin	27A / pin			
	5						
6							
Rated Voltage	1,000V AC/DC						

UL	Rated Current	See below table	Rated Voltage	600V AC/DC
C-UL		See above table (Temperature rise: 30°C)		
TÜV		See above table		

UL/TÜV File No. and Certification No. :
 UL : E52653
 C-UL : E52653
 TÜV : R50244085
 : R50400864 (DF60F)

UL Rated Current (At an ambient temp. of 25°C) (Note1)(Note5)	No. of Pos.	8 AWG	10 AWG	12 AWG
	1	65A / pin	55A / pin	45A / pin
	2			40A / pin
	3	55A / pin	50A / pin	35A / pin
	4			
	5		45A / pin	
6				

Items	Specifications	Conditions
Insulation Resistance	1000M Ω Min.	Measured at 1000V DC
Withstanding Voltage	No flashover or insulation breakdown	3000V AC rms for 1 min
Contact Resistance	2m Ω Max.	Measured at 1A and 6V Max.
Vibration Resistance	No electrical discontinuity of 1 μ s or more.	Frequency : 10 to 500Hz, Acceleration of 98 m/s ² 2 hours in each of the 3 directions
Shock Resistance	No electrical discontinuity of 1 μ s or more.	Acceleration of 490m/s ² , 11ms, Sine halfwave : 3 times each in 3 axial directions
Humidity Resistance	Contact Resistance : 2m Ω Max. Insulation Resistance : 1000M Ω Min	96 hours at temperature of 40 \pm 2 $^{\circ}$ C and humidity of 90% to 95%
Temperature Cycles	Contact Resistance : 2m Ω Max. Insulation Resistance : 1000M Ω Min	-55 $^{\circ}$ C : 30 minutes \rightarrow 85 $^{\circ}$ C : 30 minutes, 25 cycles
Mating Durability	Contact Resistance : 2m Ω Max.	30 times
Solder Heat Resistance	No dissolution of the resin part affecting performance.	Flow : 260 $^{\circ}$ C , 10sec. Hand soldering : temperature of soldering iron at 350 \pm 10 $^{\circ}$ C for 5sec.

Note 1 : This is the maximum current rating while all pins are energized with the stated current rating.
When isolating power lines into multiple circuits, current ratings may go above the stated current ratings.
Please consult Hirose for details before doing this.

Note 2 : Includes temperature rise caused by current flow.

Note 3 : The storage condition refers to long-term storage of the product on the shelf before assembly.

Please use the operating temperature for temporary storage such as pre-assembly and during shipping.

Note 4 : Information contained in this catalog represents general requirements for this Series.

Contact us for the drawings and specifications for a specific part number shown.

Note 5 : It shows the current at an ambient temperature of 25 $^{\circ}$ C to the RTI value, the temperature at which performance is halved, of the resin.

[Reference] Derating Curve

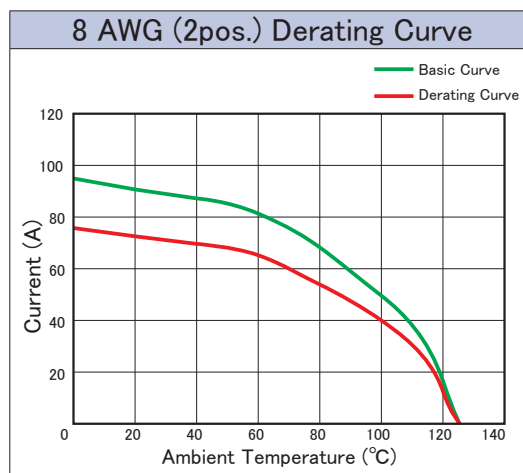

Note : The derating curve is derived from the basic curve multiplied by the derating factor of 0.8.

Materials / Finish

Item	Component	Material	Color / Finish	Remarks	RoHS2
Header	Insulator	PBT (Glass-reinforced)	Black	UL94V-0	○
	Contact	High Conductivity Copper Alloy	Gold Plating	—	
	Retention Tab	Brass	Tin Plating	—	
Crimp Socket	Insulator	PBT (Glass-reinforced)	Black	UL94V-0	
In-Line Plug	Insulator	PBT (Glass-reinforced)	Black	UL94V-0	
Crimp Contact	Contact	High Conductivity Copper Alloy	Gold Plating	—	

Product Number Structure

Refer to the chart below when determining the product specifications from the product number.
Please select from the product numbers listed in this catalog when placing orders.

Header Connector

DF60 F R - # P - 10.16 DSA

① ② ③ ④ ⑤ ⑥ ⑦

① Series Name	DF60	⑤ Connector Type	P : Pin Header
② Shape Type	Blank : Standard F : Finger-Safe	⑥ Contact Pitch	10.16mm
③ Guide Key Type	Blank : Standard R : Another Key Shape	⑦ Termination Type	DSA : Straight Pin Header DS : Right Angle Pin Header
④ No. of Pos.	1, 2, 3, 4, 5, 6		

Socket Connector

DF60 F R - # S - 10.16 C

① ② ③ ④ ⑤ ⑥ ⑦

① Series Name	DF60	⑤ Connector Type	S : Socket
② Shape Type	A : Standard F : Finger-Safe	⑥ Contact Pitch	10.16mm
③ Guide Key Type	Blank : Standard R : Another Key Shape	⑦ Termination Type	C : Crimp Socket
④ No. of Pos.	1, 2, 3, 4, 5, 6		

In-Line Plug Connector

DF60 F R - # EP - 10.16 C

① ② ③ ④ ⑤ ⑥ ⑦

① Series Name	DF60	⑤ Connector Type	EP : In-Line Plug
② Shape Type	Blank : Standard A : No Flange F : Finger-Safe	⑥ Contact Pitch	10.16mm
③ Guide Key Type	Blank : Standard R : Another Key Shape	⑦ Termination Type	C : Crimp Socket
④ No. of Pos.	1, 2, 3, 4, 5		

Crimp Contact

DF60 A - 8 SCFA

① ② ③

① Connection Type	Blank : Standard A : Sequential	③ Contact Type / Packaging Type	SCFA : Socket Contact/Reel SCA : Socket Contact/Loose Piece PCFA : In-Line Plug Contact/Reel PCA : In-Line Plug Contact/Loose Piece
② Applicable Wire Size	8 : 8 AWG 1012 : 10 to 12 AWG		

Connector Mating Combinations Diagram

●Finger-Safe Type

Crimp Socket (Cable Side)	Socket Crimp Contact
DF60F(R)-#S-10.16C (Note)	DF60-#SC(F)A

Note : R type (another key shape) socket mates with another key type of R type plug / pin header.

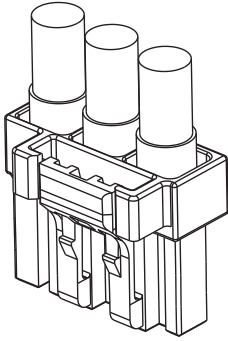

Straight Pin Header
DF60F(R)-#P-10.16DSA

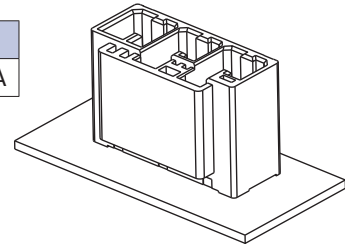

In-Line Plug (Cable Side)	Crimp Contact for In-Line Plug
DF60F(R)-#EP-10.16C	DF60-#PC(F)A

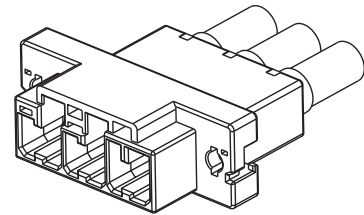

●Standard Type

Crimp Socket (Cable Side)	Socket Crimp Contact
DF60A(R)-#S-10.16C (Note)	DF60-#SC(F)A

Note : R type (another key shape) socket mates with another key type of R type plug / pin header.

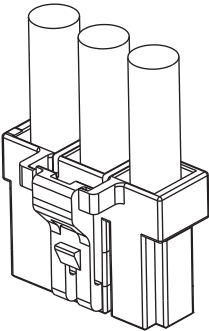

Straight Pin Header
DF60(R)-#P-10.16DSA

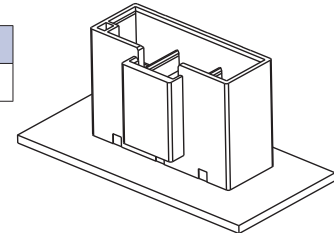

Right Angle Pin Header
DF60(R)-#P-10.16DS

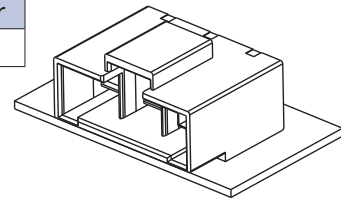

In-Line Plug (Cable Side)	Crimp Contact for In-Line Plug
DF60(A) (R)-#EP-10.16C	DF60(A)-#PC(F)A

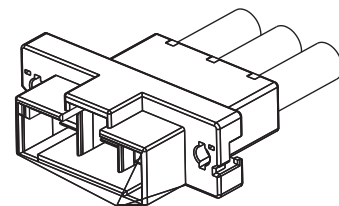

Straight Pin Header (Finger-Safe Type)



Standard Key Shape (2pos.)



Standard Key Shape (3pos.)



Another Key Shape (2pos.)



Another Key Shape (3pos.)

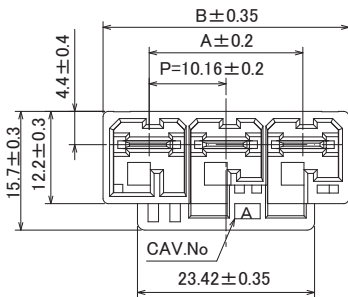

Mated Portion Shape (2pos.)

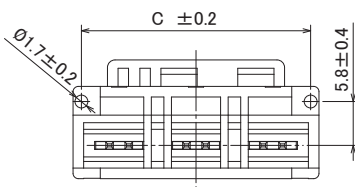
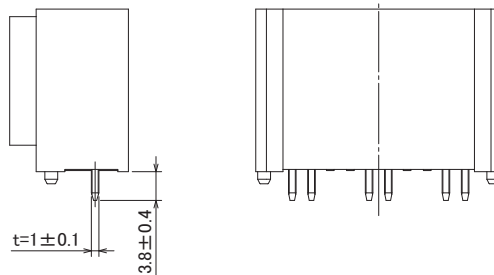
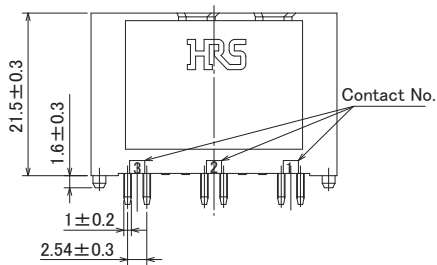
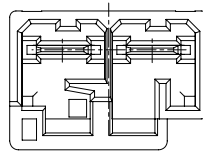

Standard Type (Guide Key : Standard, Color : Black)

Unit : mm

Part No.	HRS No.	No. of Pos.	A	B	C	D	E	Purchase Unit
DF60F-2P-10.16DSA(50)	CL0680-4007-0-50	2	10.16	22.36	20.15	22.36	17.94	96pcs per tray
DF60F-3P-10.16DSA(50)	CL0680-4001-0-50	3	20.32	32.52	30.31	32.52	28.1	64pcs per tray

R Type (Guide Key : Another Key Shape, Color : Red)

Unit : mm

Part No.	HRS No.	No. of Pos.	A	B	C	D	E	Purchase Unit
DF60FR-2P-10.16DSA(50)	CL0680-4010-0-50	2	10.16	22.36	20.15	22.36	17.94	96pcs per tray
DF60FR-3P-10.16DSA(50)	CL0680-4004-0-50	3	20.32	32.52	30.31	32.52	28.1	64pcs per tray

Note : As for UL,C-UL and TÜV standard of the two positions are in the process of being certified.

■PCB Mounting Pattern (Recommended Board Thickness : $t=1.6\pm 0.1$)

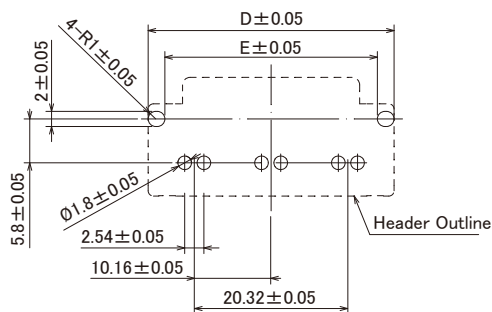

In-Line Plug (Finger-Safe Type)

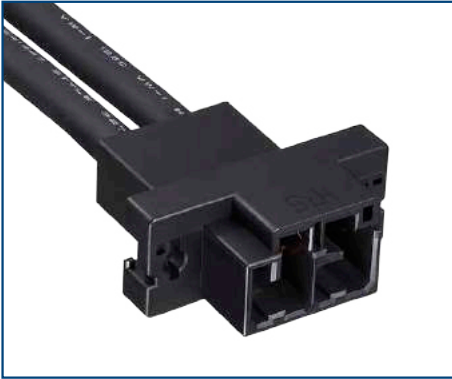

Standard Key Shape (2pos.)



Standard Key Shape (3pos.)



Another Key Shape (2pos.)

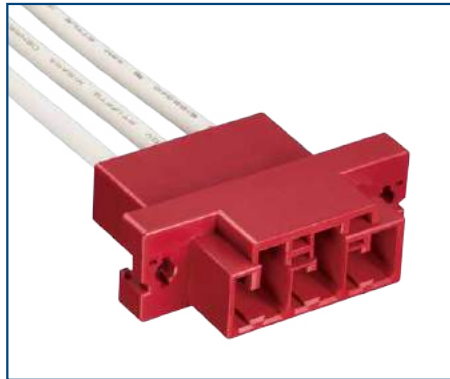

Another Key Shape (3pos.)

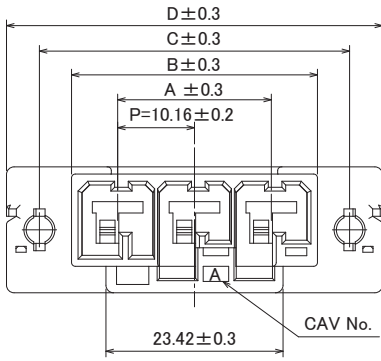

Mated Portion Shape (2pos.)

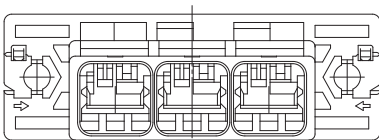
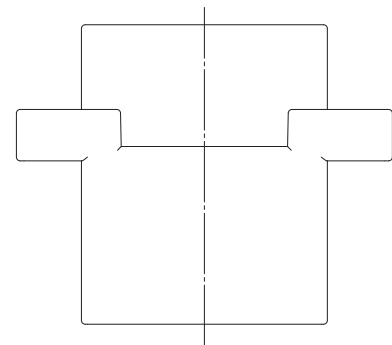
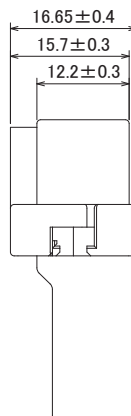
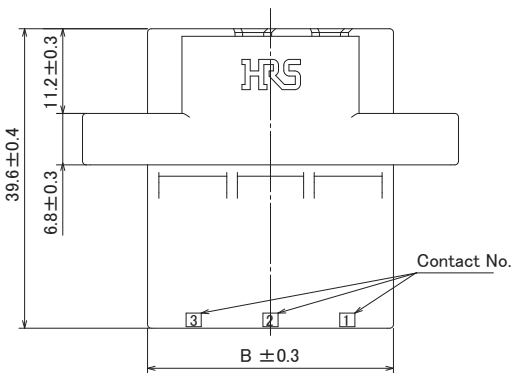
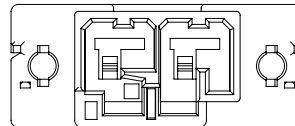

Standard Type (Guide Key : Standard, Color : Black)

Unit : mm

Part No.	HRS No.	No. of Pos.	A	B	C	D	E	Purchase Unit
DF60F-2EP-10.16C	CL0680-4009-0-00	2	-	22.36	30.86	39.56	22.36	100pcs per tray
DF60F-3EP-10.16C	CL0680-4003-0-00	3	20.32	32.52	41.02	49.72	32.52	

R Type (Guide Key : Another Key Shape, Color : Red)

Unit : mm

Part No.	HRS No.	No. of Pos.	A	B	C	D	E	Purchase Unit
DF60FR-2EP-10.16C	CL0680-4012-0-00	2	-	22.36	30.86	39.56	22.36	100pcs per tray
DF60FR-3EP-10.16C	CL0680-4006-0-00	3	20.32	32.52	41.02	49.72	32.52	

Note 1 : For better finger-safe function, heat shrink tube shall be installed to crimp contact of in-line plug.

(Recommended heat shrink tube : Sumitomo Electric Industries, Ltd. F2(Z)8 × 0.25)

For the details, please see DF60 cable assembly procedure. (ETAD-H0653-00)

Note 2 : As for UL, C-UL and TÜV standard of the two positions are in the process of being certified.

■ Panel Cut-Out Dimensions

[3pos.]

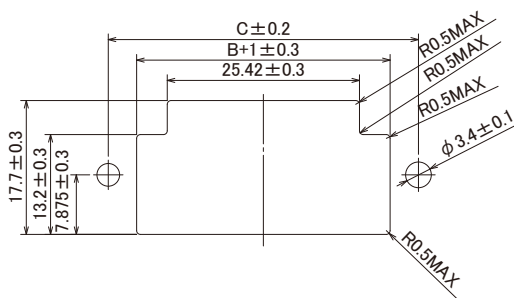

[2pos.]

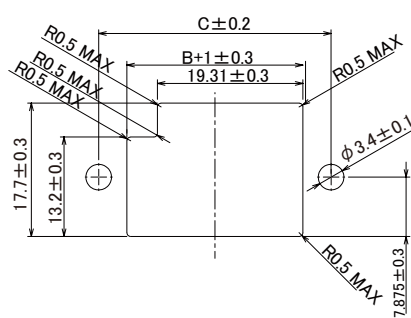

Crimp Socket (Finger-Safe Type)



Standard Key Shape (2pos.)



Standard Key Shape (3pos.)

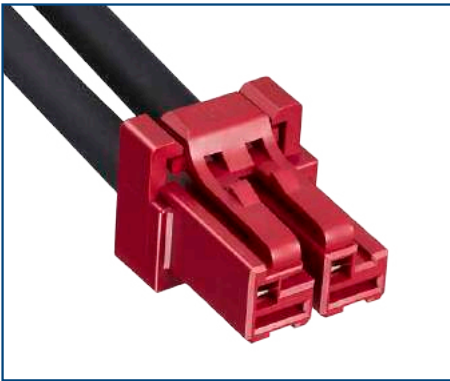

Another Key Shape (2pos.)

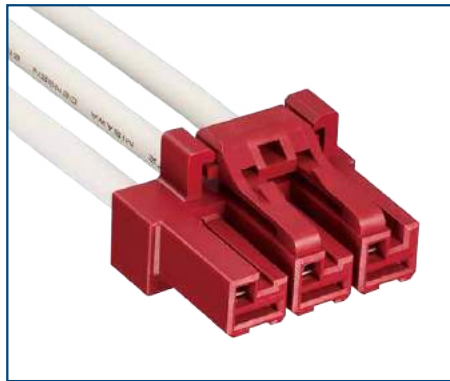

Another Key Shape (3pos.)

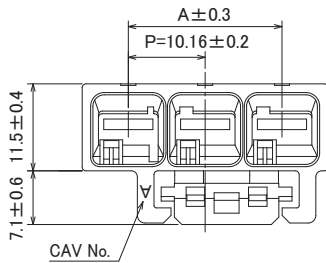

Mated Portion Shape (2pos.)

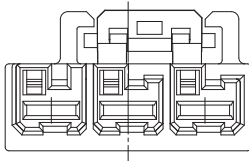
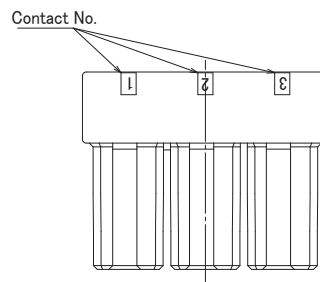
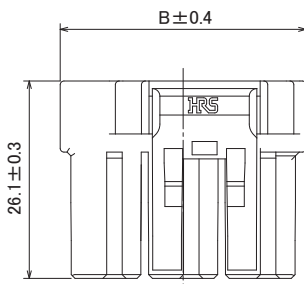
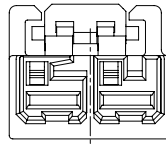

Standard Type (Guide Key : Standard, Color : Black)

Unit : mm

Part No.	HRS No.	No. of Pos.	A	B	Purchase Unit
DF60F-2S-10.16C	CL0680-4008-0-00	2	10.16	22.36	100pcs per tray
DF60F-3S-10.16C	CL0680-4002-0-00	3	20.32	32.52	

R Type (Guide Key : Another Key Shape, Color : Red)

Unit : mm

Part No.	HRS No.	No. of Pos.	A	B	Purchase Unit
DF60FR-2S-10.16C	CL0680-4011-0-00	2	10.16	22.36	100pcs per tray
DF60FR-3S-10.16C	CL0680-4005-0-00	3	20.32	32.52	

Note1 : For better finger-safe function, heat shrink tube shall be installed to crimp contact of socket.
 (Recommended heat shrink tube : Sumitomo Electric Industries, Ltd. F2(Z)8 × 0.25)

For the details, please see DF60 cable assembly procedure. (ETAD-H0653-00)

Note 2 : As for UL,C-UL and TÜV standard of the two positions are in the process of being certified.

Straight Pin Header



3pos.



5pos.

1 to 4pos.

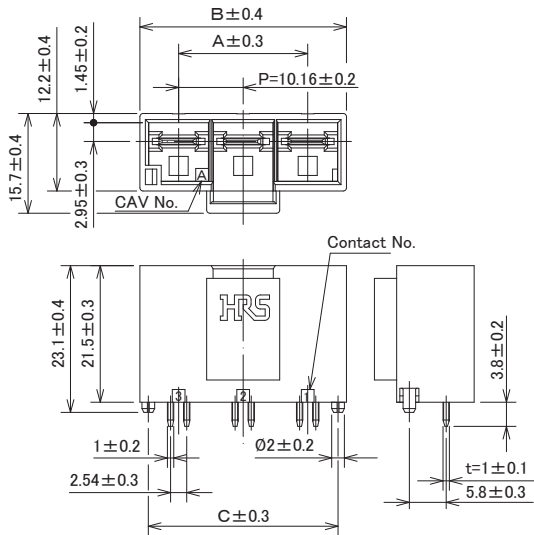

5 and 6pos.

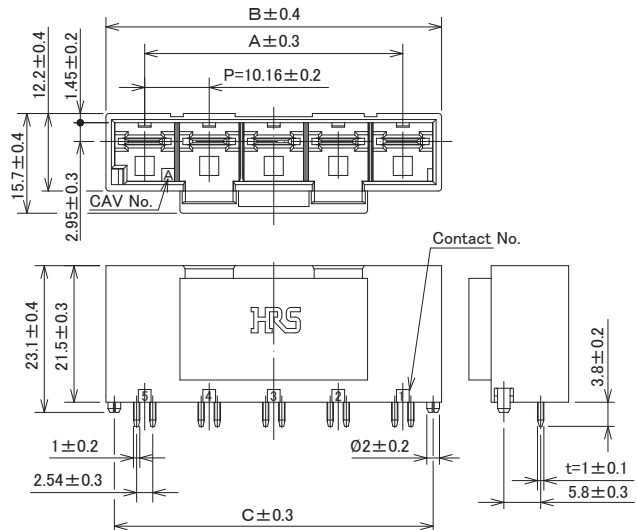

Standard Type (Guide Key : Standard, Color : Black)

Unit : mm

Part No.	HRS No.	No. of Pos.	A	B	C	D	E	Purchase Unit
DF60-1P-10.16DSA(27)	CL0680-3004-5-27	1	-	15.2	9.55	12.2	7.78	160pcs per tray
DF60-2P-10.16DSA(27)	CL0680-3005-8-27	2	10.16	22.36	19.71	22.36	17.94	96pcs per tray
DF60-3P-10.16DSA(27)	CL0680-3001-7-27	3	20.32	32.52	29.87	32.52	28.1	64pcs per tray
DF60-4P-10.16DSA(27)	CL0680-3006-0-27	4	30.48	42.68	40.03	42.68	38.26	48pcs per tray
DF60-5P-10.16DSA(27)	CL0680-3007-3-27	5	40.64	52.84	50.19	52.84	48.42	32pcs per tray
DF60-6P-10.16DSA(27)	CL0680-3008-6-27	6	50.8	63	60.35	63	58.58	

Standard Type [Colored] (Guide Key : Standard, Color : Red)

Unit : mm

Part No.	HRS No.	No. of Pos.	A	B	C	D	E	Purchase Unit
DF60-2P-10.16DSA(45)	CL0680-3005-8-45	2	10.16	22.36	19.71	22.36	17.94	96pcs per tray
DF60-3P-10.16DSA(45)	CL0680-3001-7-45	3	20.32	32.52	29.87	32.52	28.1	64pcs per tray

R Type (Guide Key : Another Key Shape, Color : Red)

Unit : mm

Part No.	HRS No.	No. of Pos.	A	B	C	D	E	Purchase Unit
DF60R-3P-10.16DSA(27)	CL0680-3038-7-27	3	20.32	32.52	29.87	32.52	28.1	64pcs per tray

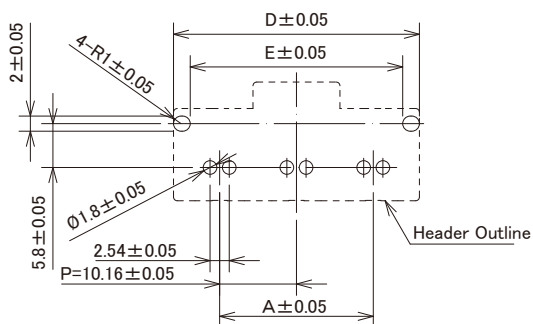
PCB Mounting Pattern (Recommended Board Thickness : $t=1.6\pm0.1$)

Right Angle Pin Header



3pos.



5pos.

1 to 4pos.

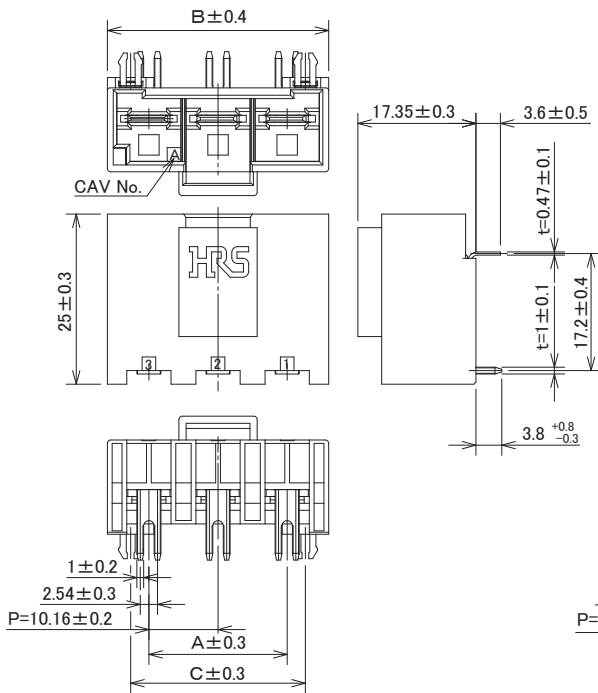

5 and 6pos.

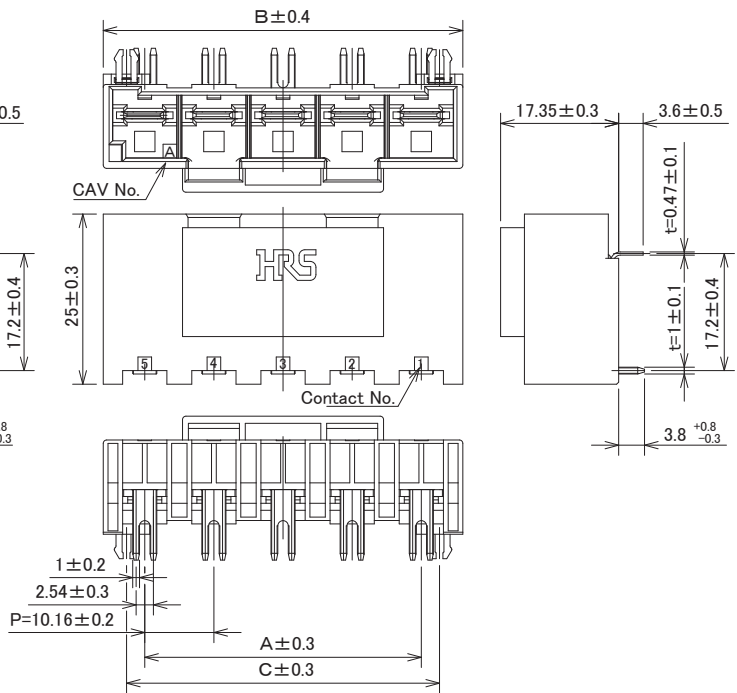

Standard Type (Guide Key : Standard, Color : Black)

Unit : mm

Part No.	HRS No.	No. of Pos.	A	B	C	Purchase Unit
DF60-1P-10.16DS(27)	CL0680-3015-1-27	1	-	15.2	8.35	120pcs per tray
DF60-2P-10.16DS(27)	CL0680-3016-4-27	2	10.16	22.36	15.51	72pcs per tray
DF60-3P-10.16DS(27)	CL0680-3017-7-27	3	20.32	32.52	25.67	48pcs per tray
DF60-4P-10.16DS(27)	CL0680-3018-0-27	4	30.48	42.68	35.83	36pcs per tray
DF60-5P-10.16DS(27)	CL0680-3019-2-27	5	40.64	52.84	45.99	24pcs per tray
DF60-6P-10.16DS(27)	CL0680-3020-1-27	6	50.8	63	56.15	

Standard Type [Colored] (Guide Key : Standard, Color : Red)

Part No.	HRS No.	No. of Pos.	A	B	C	Purchase Unit
DF60-2P-10.16DS(45)	CL0680-3016-4-45	2	10.16	22.36	15.51	72pcs per tray

R Type (Guide Key : Another Key Shape, Color : Gray)

Unit : mm

Part No.	HRS No.	No. of Pos.	A	B	C	Purchase Unit
DF60R-2P-10.16DS(27)	CL0680-3043-7-27	2	10.16	22.36	15.51	72pcs per tray
DF60R-3P-10.16DS(27)	CL0680-3044-0-27	3	20.32	32.52	25.67	48pcs per tray

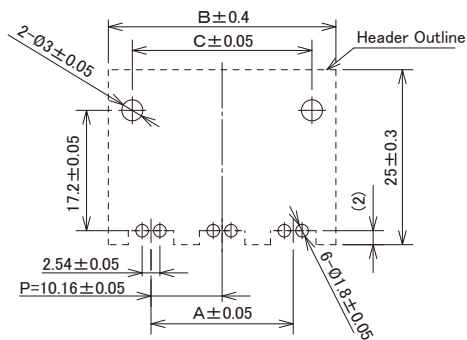
■PCB Mounting Pattern (Recommended Board Thickness : $t=1.6\pm0.1$)

In-Line Plug



Standard Type (3pos.)



Without Flange Type (4pos.)

Standard Type (1 to 5pos.)

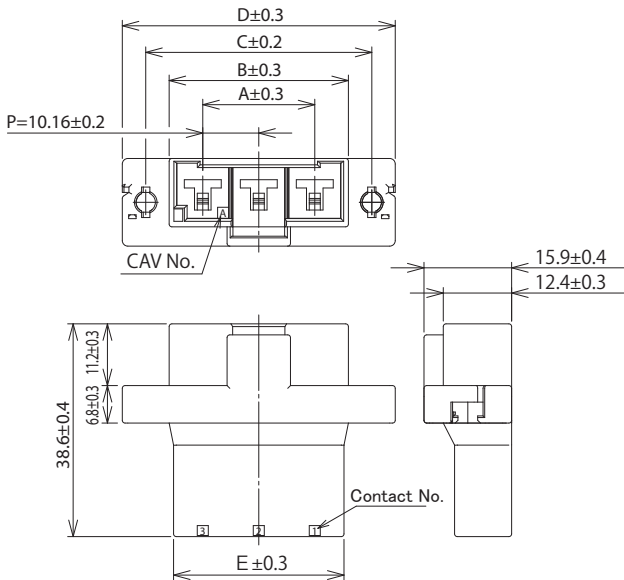

Without Flange Type (4pos.)

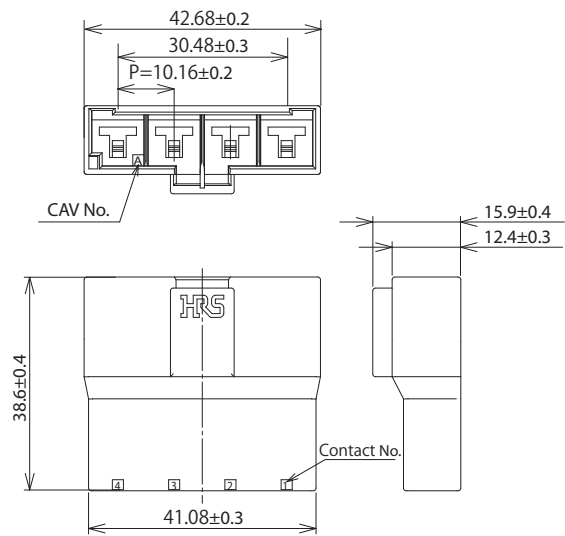

Standard Type (Guide Key : Standard, Color : Black)

Unit : mm

Part No.	HRS No.	No. of Pos.	A	B	C	D	E	Purchase Unit
DF60-1EP-10.16C	CL0680-3050-2-00	1	-	15.2	23.7	32.2	10.6	100pcs per bag
DF60-2EP-10.16C	CL0680-3025-5-00	2	-	22.36	30.86	39.36	20.76	
DF60-3EP-10.16C	CL0680-3026-8-00	3	20.32	32.52	41.02	49.52	30.92	
DF60-4EP-10.16C	CL0680-3027-0-00	4	30.48	42.68	51.18	59.68	41.08	
DF60-5EP-10.16C	CL0680-3028-3-00	5	40.64	52.84	61.34	69.84	51.24	

Standard Type [Colored] (Guide Key : Standard, Color : Red)

Unit : mm

Part No.	HRS No.	No. of Pos.	A	B	C	D	E	Purchase Unit
DF60-1EP-10.16C(15)	CL0680-3050-2-15	1	-	15.2	23.7	32.2	10.6	100pcs per bag
DF60-2EP-10.16C(15)	CL0680-3025-5-15	2	-	22.36	30.86	39.36	20.76	
DF60-3EP-10.16C(15)	CL0680-3026-8-15	3	20.32	32.52	41.02	49.52	30.92	

R Type (Guide Key : Another Key Shape, Color : Gray)

Unit : mm

Part No.	HRS No.	No. of Pos.	A	B	C	D	E	Purchase Unit
DF60R-2EP-10.16C	CL0680-3053-0-00	2	-	22.36	30.86	39.36	20.76	100pcs per bag
DF60R-3EP-10.16C	CL0680-3054-0-00	3	20.32	32.52	41.02	49.52	30.92	

Without Flange Type (Guide Key : Standard, Color : Black)

Unit : mm

Part No.	HRS No.	No. of Pos.	Purchase Unit
DF60A-4EP-10.16C	CL0680-3069-0-00	4	100pcs per bag

■ Panel Cut-Out Dimensions

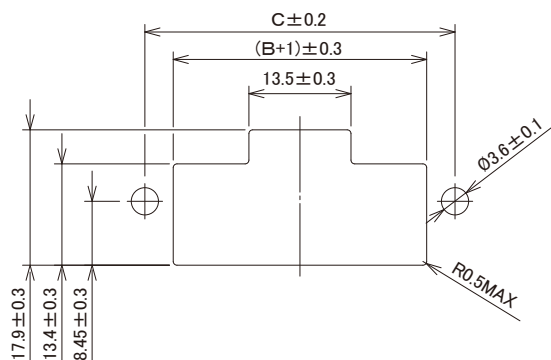

Crimp Socket



3pos.



5pos.

1 to 4pos.

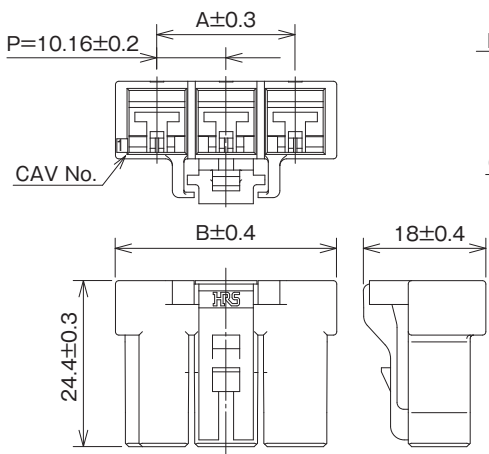

5 and 6pos.

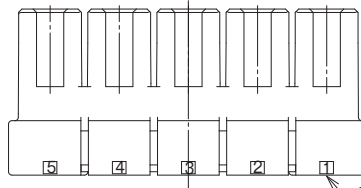
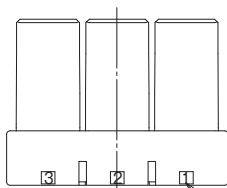
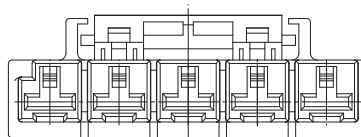
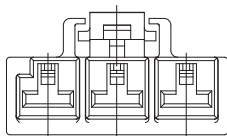
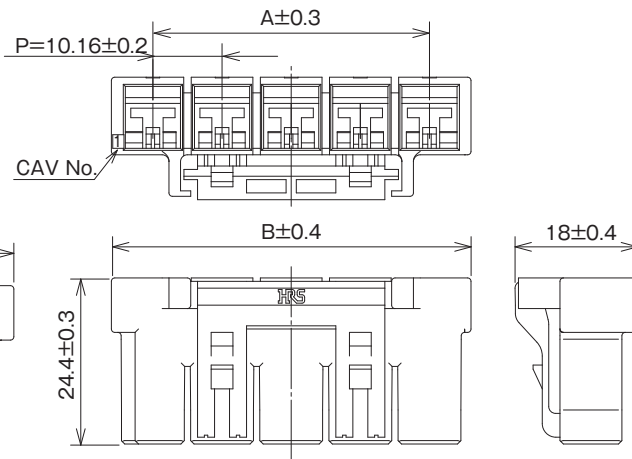

Contact No.

Contact No.

Standard Type (Guide Key : Standard, Color : Black)

Unit : mm

Part No.	HRS No.	No. of Pos.	A	B	Purchase Unit
DF60A-1S-10.16C	CL0680-3058-0-00	1	-	15.8	100pcs per bag
DF60A-2S-10.16C	CL0680-3059-0-00	2	10.16	22.36	
DF60A-3S-10.16C	CL0680-3060-0-00	3	20.32	32.52	
DF60A-4S-10.16C	CL0680-3061-0-00	4	30.48	42.68	
DF60A-5S-10.16C	CL0680-3076-0-00	5	40.64	52.84	
DF60A-6S-10.16C	CL0680-3077-0-00	6	50.8	63	

Standard Type [Colored] (Guide Key : Standard, Color : Red)

Unit : mm

Part No.	HRS No.	No. of Pos.	A	B	Purchase Unit
DF60A-1S-10.16C(15)	CL0680-3058-0-15	1	-	15.8	100pcs per bag
DF60A-2S-10.16C(15)	CL0680-3059-0-15	2	10.16	22.36	
DF60A-3S-10.16C(15)	CL0680-3060-0-15	3	20.32	32.52	

R Type (Guide Key : Another Key Shape, Color : Gray)

Unit : mm

Part No.	HRS No.	No. of Pos.	A	B	Purchase Unit
DF60AR-2S-10.16C	CL0680-3063-0-00	2	10.16	22.36	100pcs per bag
DF60AR-3S-10.16C	CL0680-3064-0-00	3	20.32	32.52	

Socket Crimp Contact

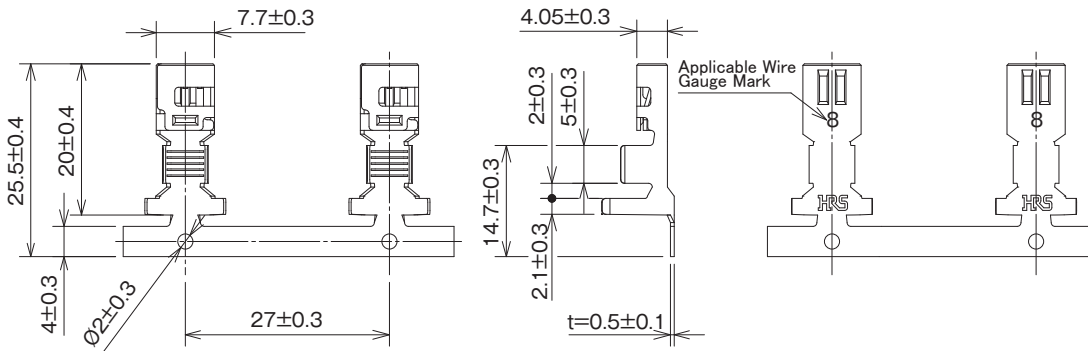

Strip Length : 6.5 to 7.5mm

Unit : mm

Part No.	HRS No.	Applicable Wire (Tin Plated Copper Wire) (Note)					
		UL	Jacket Diameter	AWG	Core Structure	Packing Type	Purchase Unit
DF60-8SCFA	CL0680-3003-2-00	1283	4.9 to 7.8	8	7/24/0.26	Reel	700pcs per reel
DF60-8SCA	CL0680-3021-4-00		7.54			Loose Piece	100pcs per bag
DF60-1012SCFA	CL0680-3014-9-00	1015	4 to 5.2	10	104/0.26	Reel	900pcs per reel
				12	65/0.26		
DF60-1012SCA	CL0680-3022-7-00	1015	4.69	10	104/0.26	Loose Piece	100pcs per bag
				4.04	12		

Note : Please contact our sales department when using wires other than those listed.

Crimp Contact for In-Line Plug

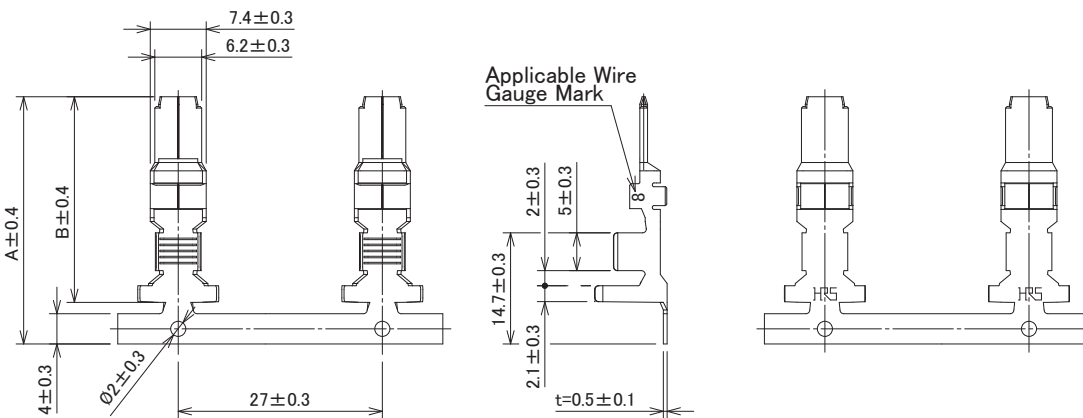

Strip Length : 6.5 to 7.5mm

Unit : mm

Part No.	HRS No.	A	B	Applicable Wire (Tin Plated Copper Wire) (Note 1)					
				UL	Jacket Diameter	AWG	Core Structure	Packing Type	Purchase Unit
DF60A-8PCFA(Note 2)	CL0680-3057-0-00	34.2	28.7	1283	4.9 to 7.8	8	7/24/0.26	Reel	700pcs per reel
DF60-8PCFA(07)	CL0680-3023-0-07	32.7	27.2					Loose Piece	100pcs per bag
DF60-8PCA(07)	CL0680-3048-0-07				7.54				
DF60-1012PCFA(07)	CL0680-3024-2-07	32.7	27.2	1015	4 to 5.2	10	104/0.26	Reel	900pcs per reel
						12	65/0.26		
DF60-1012PCA(07)	CL0680-3049-3-07	32.7	27.2	1015	4.69	10	104/0.26	Loose Piece	100pcs per bag
					4.04	12	65/0.26		

Note 1 : Please contact our sales department when using wires other than those listed.

Note 2 : Not conforming to finger-safe type.

Applicable Crimping Tool

Item	Part No.	HRS No.	Applicable Contact	Remarks
Applicator	AP105-DF60-8	CL0901-4623-5-00	DF60-8SCFA	(Note 4)manufactured by Japan Automatic Machine Co., Ltd.
	QHS895700H-UP	—	DF60-8PCFA(07) DF60A-8PCFA	
	AP105-DF60-1012	CL0901-4624-8-00	DF60-1012SCFA	(Note 4)manufactured by Japan Automatic Machine Co., Ltd.
	QHS888000K-UP	—	DF60-1012PCFA(07)	
Hand tool	HT306/DF60-8	CL0550-0301-4-00	DF60-8SCA DF60-8PCA(07) *Exclusive for UL1283, 8 AWG	
	HT306/DF60-1012	CL0550-0307-0-00	DF60-1012SCA DF60-1012PCA(07) *Exclusive for UL1015, 10 and 12 AWG	

Note 1 : The Hirose Press Unit CM-105C (HRS No.901-0001-0) has a capacity of 1.5 tons and cannot be used.

Please use a press unit which can mount official Hirose's applicators and has a capacity of 3 tons or more.

Note 2 : Please contact our Sales Department when you are using crimp tools made by other manufacturers.

Note 3 : Please do the crimping operations according to the "Crimping work standards" and "Crimping condition table".

Note 4 : Please contact Japan Automatic Machine Co., Ltd. (hereinafter J.A.M.) through their website regarding crimping issues when using applicators manufactured by J.A.M. URL <http://www.jam-net.co.jp>

Mated Dimensions

● Wire-to-Board Connection (Straight Pin Header)

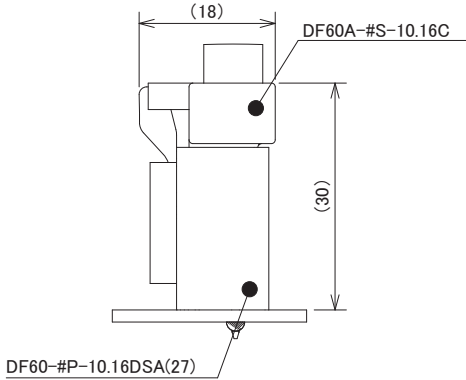

DF60F (Finger-Safe)

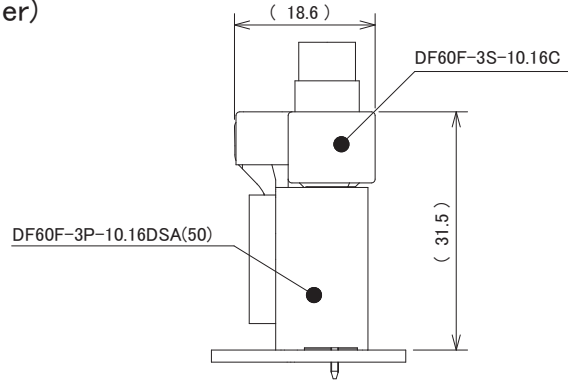

● Wire-to-Board Connection (Right Angle Pin Header)

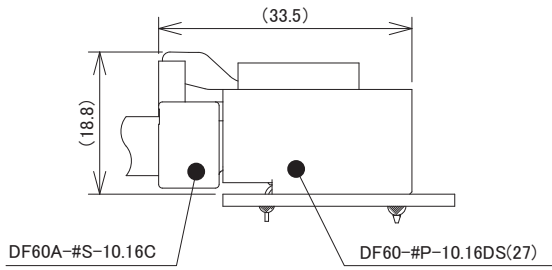

● In-Line or Wire-to-Wire Connection

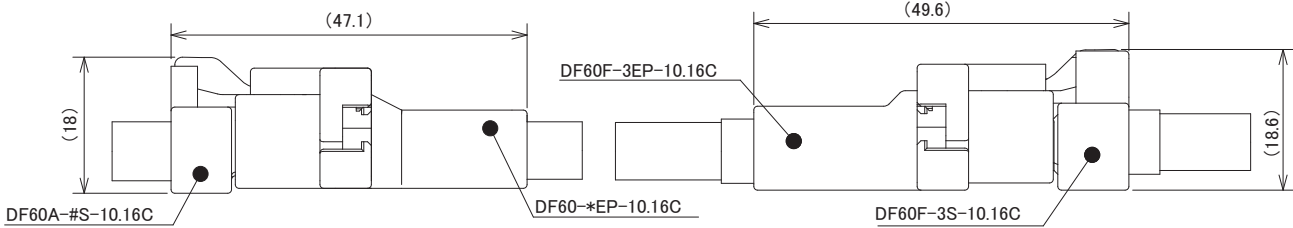

DF60F (Finger-Safe)

▪ Usage Example of Sequential Contact

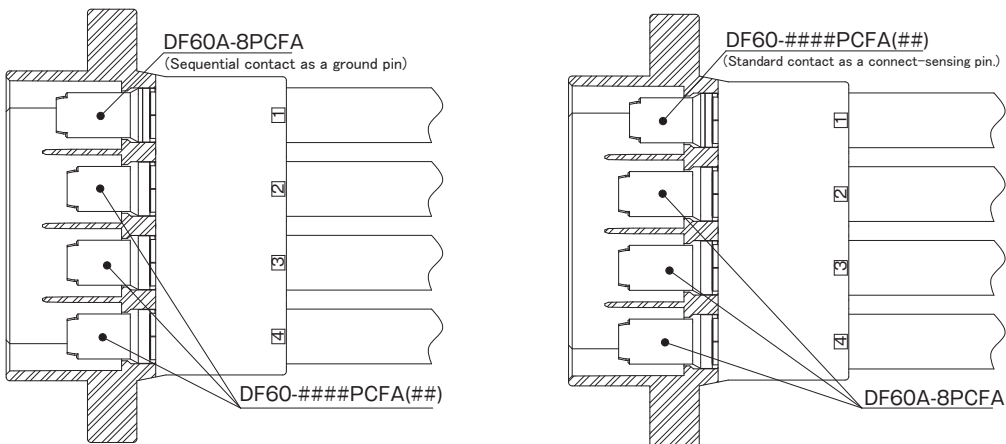

Contact Extraction

- Contact Extraction Tool : Flat-Bladed Screwdriver, 1.4mm blade width.
- Intended Crimp Contacts : DF60-8SC(F)A, DF60-1012SC(F)A, DF60-8PC(F)A, DF60-1012PC(F)A

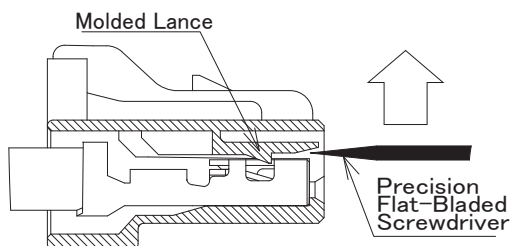

1. After unmating the parts, position the flat-bladed screwdriver to raise the lance as shown in the illustration.

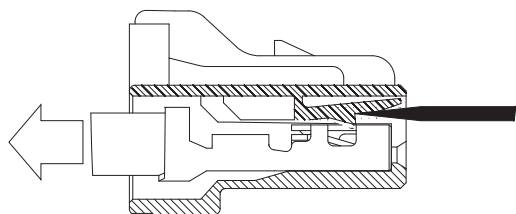

2. The lance needs to be raised sufficiently to allow the terminated wire to slip past it. The lance needs to be held up while at the same time pulling on the wire.

*Due to any previous repairs, the strength of the lance could have been deteriorated. Hirose recommends to use new crimp housing to assure proper performance.

⚠ Caution There are parts on the crimp contact that can cause injuries, please use caution when unmating the contacts.

Rated Values

Please avoid using the connectors above the ratings. Also, do not hot swap (Note 1).

Note 1 : Hot swap refers to insertion while electricity is running.

Precautions

1. Recommended Soldering Conditions

- Soldering profile when using an automatic soldering device
Soldering temperature : 260°C, Soldering time : within 10 seconds
- Hand Soldering Conditions
Temperature of soldering iron : 350±10°C , Soldering time : within 3 seconds

2. Cleaning Conditions

Please refer to the "Wire-to-Board Connector Guide".

Cleaning with IPA is allowed. (Other cleaning agents are not recommended due to may have caused changing the push pull feeling. Please contact us when you use other cleaning agents.)

3. Important Notes

1. Caution is required for mating and un-mating the connector without it being mounting on a PCB. It can damage or deform the contacts.
2. During hand soldering, do not apply flux which can cause creeping-up flux to the connector.
3. This product may have a slight difference in color depending on the production lot. This difference does not have any influence on the performance.
4. The connector could be damaged if it is pulled out forcibly. When it is hard to pull out, push it in slightly first and then depress the lock and unmate. Please refer to "DF60 Series mating and unmating Procedure Document (ETAD-H0654-00)" for points in handling regarding mating operations.
5. When thick and short wire are used, the connector could be deformed due to the force of the wire's position. Route cables in such a way that they do not twist when being installed.
6. Make sure to turn off the power when mating or unmating the connector.
7. Please do not touch any area around the contact part during energizing. It could be very dangerous.
8. Please refer to "Harness procedure manual (ETAD-H0653-00)" for points in harness operations.

4. Precautions for use

Please refer to the "Wire-to-Board Connector Guide".

5. Precautions for use of right angle pin header

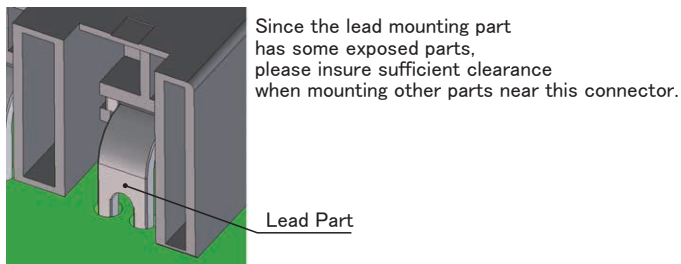

6. Panel fixing operation of In-Line connector

- (1) Insert a M3 nut from the lateral direction. (2) Push the nut in the direction of the arrow.

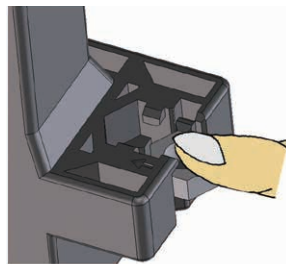
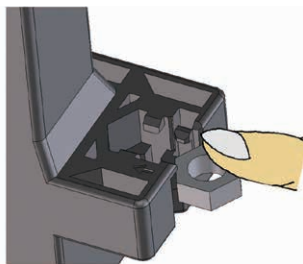

- (3) Nut insertion is then complete.

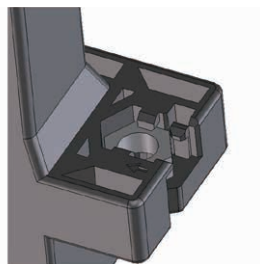

- (4) Panel mounting is completed by installing a connector on the panel cutout hole and tightening with a M3 screw.

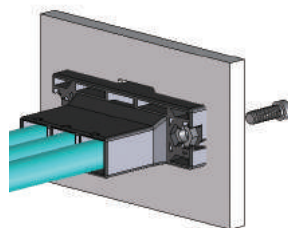

7. Operating Environment

Please contact us if you are designing this connector into environmental conditions where high and low temperatures are repeated.

While Taking into Consideration

Specifications mentioned in this catalog are reference values.

When considering to order or use this product, please review the Drawing and Product Specifications sheets.

Use an appropriate cable when using the connector in combination with cables.

If considering usage of a non-specified cable, please contact your sales representative.

If assembly process is done by jigs & tools which are not identified by Hirose, the warranty of the product may be affected.

If considering usage for below mentioned applications, please contact your sales representative.

In cases where the application will demand a high level of reliability, such as automotive, medical instruments, public infrastructure, aerospace/ defense etc. Hirose must review before assurance of reliability can be given.

HIROSE**HIROSE ELECTRIC CO.,LTD.**2-6-3 Nakagawa Chuoh, Tsuzuki-Ku, Yokohama-Shi 224-8540, JAPAN
<https://www.hirose.com>

Mouser Electronics

Authorized Distributor

Click to View Pricing, Inventory, Delivery & Lifecycle Information:

[Hirose Electric:](#)

[DF60-2P-10.16DSA\(26\)](#) [DF60-5P-10.16DSA\(26\)](#) [DF60-4P-10.16DSA\(26\)](#) [DF60-5S-10.16C](#) [DF60-2P-10.16DS\(26\)](#)
[DF60-4S-10.16C](#) [DF60-4P-10.16DS\(26\)](#) [DF60-2S-10.16C](#) [DF60-1S-10.16C](#) [DF60-3S-10.16C](#) [DF60-8SCFA](#) [DF60-1P-10.16DS\(26\)](#) [DF60-6P-10.16DSA\(26\)](#) [DF60-1P-10.16DSA\(26\)](#) [DF60-6S-10.16C](#) [DF60-6P-10.16DS\(26\)](#) [DF60-3P-10.16DS\(26\)](#) [DF60-3P-10.16DSA\(26\)](#) [DF60-5P-10.16DS\(26\)](#) [DF60-3EP-10.16C](#) [DF60-5EP-10.16C](#) [DF60-4EP-10.16C](#) [DF60-2EP-10.16C](#) [DF60-8PCFA](#) [DF60-1012SCFA](#) [DF60-1012PCFA](#) [DF60-8PCFA\(07\)](#) [DF60A-8PCFA](#) [DF60-1012PCA](#) [DF60-1012SCA](#) [DF60-1EP-10.16C](#) [DF60-1S-10.16C\(15\)](#) [DF60-2S-10.16C\(15\)](#) [DF60-3S-10.16C\(15\)](#) [DF60-8PCA](#) [DF60-8SCA](#) [DF60R-2EP-10.16C](#) [DF60R-2S-10.16C](#) [DF60R-3EP-10.16C](#) [DF60R-3S-10.16C](#) [DF60R-3P-10.16DS\(27\)](#) [DF60-5P-10.16DSA\(27\)](#) [DF60-6P-10.16DS\(27\)](#) [DF60-4P-10.16DS\(27\)](#) [DF60-3P-10.16DSA\(45\)](#) [DF60-6P-10.16DSA\(27\)](#) [DF60R-3P-10.16DSA\(27\)](#) [DF60-1P-10.16DS\(27\)](#) [DF60R-3P-10.16DS\(26\)](#) [DF60R-2P-10.16DS\(26\)](#) [DF60-2P-10.16DS\(45\)](#) [DF60-5P-10.16DS\(27\)](#) [DF60-2P-10.16DS\(27\)](#) [DF60-4P-10.16DSA\(27\)](#) [DF60-3P-10.16DSA\(35\)](#) [DF60-2P-10.16DSA\(45\)](#) [DF60R-3P-10.16DSA\(26\)](#) [DF60R-2P-10.16DS\(27\)](#) [DF60-3P-10.16DS\(27\)](#) [DF60-2P-10.16DSA\(27\)](#) [DF60-3P-10.16DSA\(27\)](#) [DF60-1P-10.16DSA\(27\)](#) [DF60-8PCA\(07\)](#) [DF60A-1S-10.16C](#) [DF60A-2S-10.16C\(15\)](#) [DF60A-2S-10.16C](#) [DF60A-4S-10.16C](#) [DF60-1012PCA\(07\)](#) [DF60A-5S-10.16C](#) [DF60AR-3S-10.16C](#) [DF60-1EP-10.16C\(15\)](#) [DF60AR-2S-10.16C](#) [DF60A-3S-10.16C](#) [DF60A-3S-10.16C\(15\)](#) [DF60A-6S-10.16C](#) [DF60A-1S-10.16C\(15\)](#) [DF60-3EP-10.16C\(15\)](#) [DF60-1012PCFA\(07\)](#) [DF60-2EP-10.16C\(15\)](#)