

## High Side Power Switches

### Features

- 1.7V to 5.5V Input Voltage Range
- 2A Continuous Operating Current
- 77 mΩ (typ.)  $R_{DS(ON)}$
- Built-In Level Shift for Control Logic; Can be Operated by 1.5V Logic
- Low 2 μA Quiescent Current
- Soft-Start: MIC94062, MIC94063
- Micropower Shutdown <1 μA
- Load Discharge Circuit: MIC94061, MIC94063
- Space Saving 1.2 mm x 1.6 mm UDFN Package

### Applications

- Load Switch in Portable Applications
  - Cellular Phones
  - PDAs
  - MP3 Players
  - Digital Cameras
  - Portable Instrumentation
- Battery Switch-Over Circuits
- Level Translator

### General Description

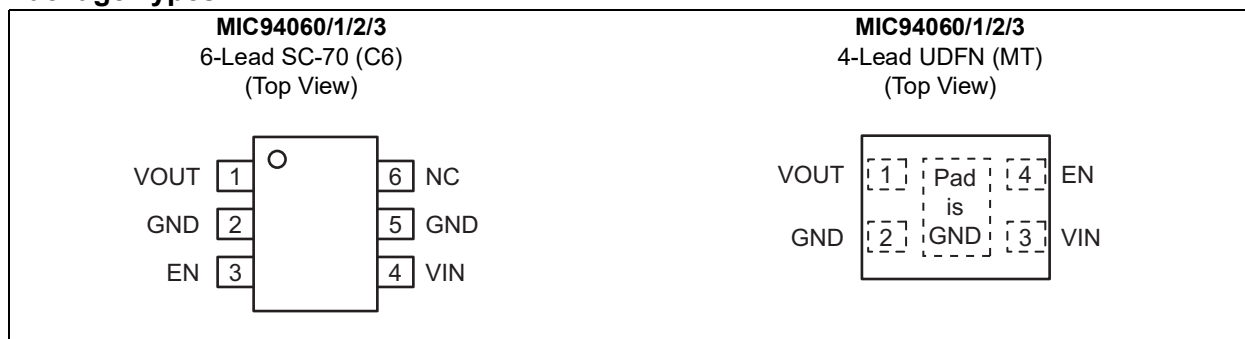
The MIC94060, MIC94061, MIC94062, and MIC94063 are high-side load switches designed for operation between 1.7V to 5.5V. The devices contain a low on-resistance P-channel MOSFET that supports over 2A of continuous current. The MIC94061 and MIC94063 feature an active load discharge circuit which ensures capacitive loads retain no charge when the main switch is in an OFF state.

MIC94060-61 feature rapid turn-on while MIC94062-63 provide a slew-rate controlled soft-start turn-on of 800 μs (typical) to prevent in-rush current from glitching supply rails.

An active pull-down on the enable input keeps MIC94060-63 in a default OFF state until the EN pin is pulled to a high level. Built-in level shift circuitry allows low voltage logic signals to switch higher supply voltages, or vice versa; high level logic signals can control low level voltages.

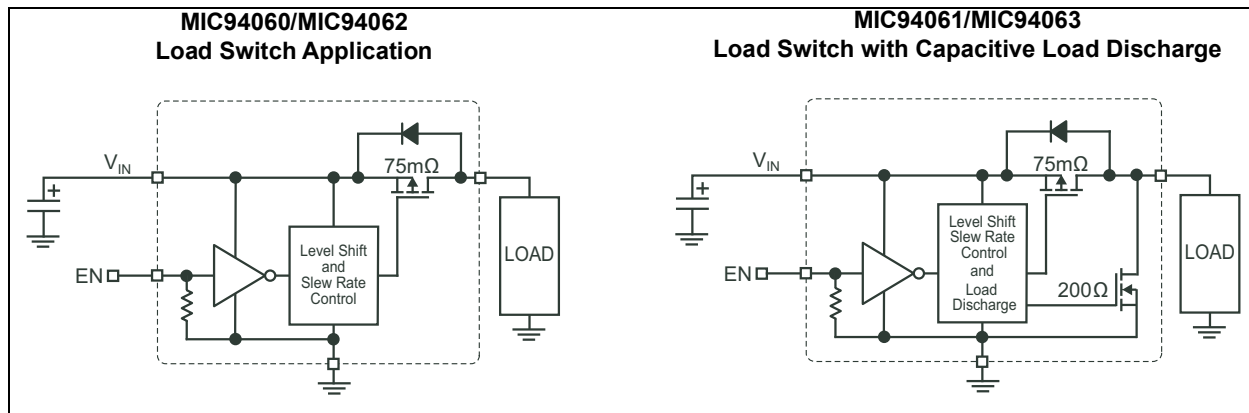
MIC94060-63's operating voltage range makes them suitable for 1-cell Lithium ion and 2- to 3-cell NiMH/NiCad/Alkaline powered systems, as well as all 5V applications. Their low operating current of 2 μA and low shutdown current of <1 μA maximize battery life.

### Package Types



# MIC94060/1/2/3

## Typical Application Circuits



## 1.0 ELECTRICAL CHARACTERISTICS

### Absolute Maximum Ratings †

Input Voltage ( $V_{IN}$ )	+6V
Enable Voltage ( $V_{EN}$ )	+6V
Continuous Drain Current ( $I_D$ ) (Note 1)	
$T_A = 25^\circ\text{C}$	$\pm 2\text{A}$
$T_A = 85^\circ\text{C}$	$\pm 1.4\text{A}$
Pulsed Drain Current ( $I_{DP}$ ) (Note 2)	$\pm 6\text{A}$
Continuous Diode Current ( $I_S$ ) (Note 3)	-50 mA
ESD Rating, HBM (Note 4)	4 kV

### Operating Ratings ††

Input Voltage ( $V_{IN}$ )	+1.7V to +5.5V
----------------------------	----------------

† **Notice:** Stresses above those listed under “Absolute Maximum Ratings” may cause permanent damage to the device. This is a stress rating only and functional operation of the device at those or any other conditions above those indicated in the operational sections of this specification is not intended. Exposure to maximum rating conditions for extended periods may affect device reliability.

†† **Notice:** The device is not guaranteed to function outside its operating ratings.

**Note 1:** With backside thermal contact to PCB.

**2:** Pulse width <300  $\mu\text{s}$  with <2% duty cycle.

**3:** Continuous body diode current conduction (reverse conduction, i.e.  $V_{OUT}$  to  $V_{IN}$ ) is not recommended.

**4:** Devices are ESD sensitive. Handling precautions recommended. Human body model, 1.5 k $\Omega$  in series with 100 pF.

## ELECTRICAL CHARACTERISTICS

**Electrical Characteristics:**  $V_{IN} = 5\text{V}$ ;  $T_A = +25^\circ\text{C}$ , **bold** values valid for  $-40^\circ\text{C} \leq T_A \leq +85^\circ\text{C}$ , unless noted.

Parameter	Symbol	Min.	Typ.	Max.	Units	Conditions
Enable Threshold Voltage	$V_{EN\_TH}$	0.5	—	1.2	V	$V_{IN} = 1.8\text{V to } 4.5\text{V}$ , $I_D = -250 \mu\text{A}$
		0.4	—	1.2		$V_{IN} = 1.7\text{V to } 4.5\text{V}$ , $I_D = -250 \mu\text{A}$
Enable Input Current	$I_{EN}$	—	2	4	$\mu\text{A}$	$V_{IN} = V_{EN} = 5.5\text{V}$
OFF State Leakage Current	$I_{VIN}$	—	—	1	$\mu\text{A}$	$V_{IN} = +5.5\text{V}$ , $V_{EN} = 0\text{V}$
P-Channel Drain to Source ON Resistance, SC-70 Package	$R_{DS(ON)}$	—	77	110	m $\Omega$	$V_{IN}=+4.5\text{V}$ , $I_D=-100 \text{ mA}$ , $V_{EN}=1.5\text{V}$
		—	85	115		$V_{IN}=+3.6\text{V}$ , $I_D=-100 \text{ mA}$ , $V_{EN}=1.5\text{V}$
		—	100	140		$V_{IN}=+2.5\text{V}$ , $I_D=-100 \text{ mA}$ , $V_{EN}=1.5\text{V}$
		—	145	200		$V_{IN}=+1.8\text{V}$ , $I_D=-100 \text{ mA}$ , $V_{EN}=1.5\text{V}$
		—	155	215		$V_{IN}=+1.7\text{V}$ , $I_D=-100 \text{ mA}$ , $V_{EN}=1.5\text{V}$
P-Channel Drain to Source ON Resistance, UDFN Package	$R_{DS(ON)}$	—	85	115	m $\Omega$	$V_{IN}=+4.5\text{V}$ , $I_D=-100 \text{ mA}$ , $V_{EN}=1.5\text{V}$
		—	100	140		$V_{IN}=+3.6\text{V}$ , $I_D=-100 \text{ mA}$ , $V_{EN}=1.5\text{V}$
		—	145	200		$V_{IN}=+2.5\text{V}$ , $I_D=-100 \text{ mA}$ , $V_{EN}=1.5\text{V}$
		—	155	215		$V_{IN}=+1.8\text{V}$ , $I_D=-100 \text{ mA}$ , $V_{EN}=1.5\text{V}$
		—	165	225		$V_{IN}=+1.7\text{V}$ , $I_D=-100 \text{ mA}$ , $V_{EN}=1.5\text{V}$
Turn-Off Resistance	$R_{SHDN}$	—	200	300	$\Omega$	$V_{IN} = +3.6\text{V}$ , $I_{TEST} = 1 \text{ mA}$ , $V_{EN} = 0\text{V}$ , MIC94061, 63

# MIC94060/1/2/3

## ELECTRICAL CHARACTERISTICS (CONTINUED)

Electrical Characteristics:  $V_{IN} = 5V$ ;  $T_A = +25^\circ C$ , **bold** values valid for  $-40^\circ C \leq T_A \leq +85^\circ C$ , unless noted.

Parameter	Symbol	Min.	Typ.	Max.	Units	Conditions
<b>Dynamic</b>						
Turn-On Delay Time	$t_{ON\_DLY}$	—	0.85	1.5	$\mu s$	$V_{IN} = +3.6V$ , $I_D = -100 mA$ , $V_{EN} = 1.5V$ , MIC94060, 61
		—	700	1200		$V_{IN} = +3.6V$ , $I_D = -100 mA$ , $V_{EN} = 1.5V$ , MIC94062, 63
Turn-On Rise Time	$t_{ON\_RISE}$	0.5	1	5	$\mu s$	$V_{IN} = +3.6V$ , $I_D = -100 mA$ , $V_{EN} = 1.5V$ , MIC94060, 61
		500	800	1500		$V_{IN} = +3.6V$ , $I_D = -100 mA$ , $V_{EN} = 1.5V$ , MIC94062, 63
Turn-Off Delay Time	$t_{OFF\_DLY}$	—	100	200	ns	$V_{IN} = +3.6V$ , $I_D = -100 mA$ , $V_{EN} = 1.5V$ , MIC94060, 61
		—	60	200		$V_{IN} = +3.6V$ , $I_D = -100 mA$ , $V_{EN} = 1.5V$ , MIC94062, 63
Turn-Off Fall Time	$t_{OFF\_FALL}$	—	60	100	ns	$V_{IN} = +3.6V$ , $I_D = -100 mA$ , $V_{EN} = 1.5V$ , MIC94060, 61
		—	60	100		$V_{IN} = +3.6V$ , $I_D = -100 mA$ , $V_{EN} = 1.5V$ , MIC94062, 63

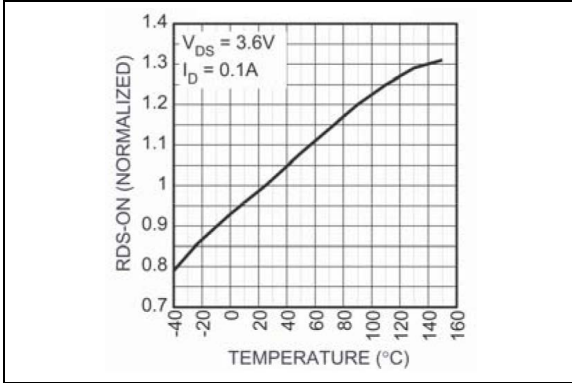
## TEMPERATURE SPECIFICATIONS

Parameters	Sym.	Min.	Typ.	Max.	Units	Conditions
<b>Temperature Ranges</b>						
Junction Temperature Range	$T_J$	-40	—	+125	$^\circ C$	—
Storage Temperature Range	$T_S$	-55	—	+150	$^\circ C$	—
<b>Package Thermal Resistances</b>						
Thermal Resistance, SC-70 6-Ld	$\theta_{JA}$	—	240	—	$^\circ C/W$	—
Thermal Resistance, UDFN 4-Ld	$\theta_{JA}$	—	172	—	$^\circ C/W$	—
Thermal Resistance, UDFN 4-Ld	$\theta_{JC}$	—	134	—	$^\circ C/W$	—

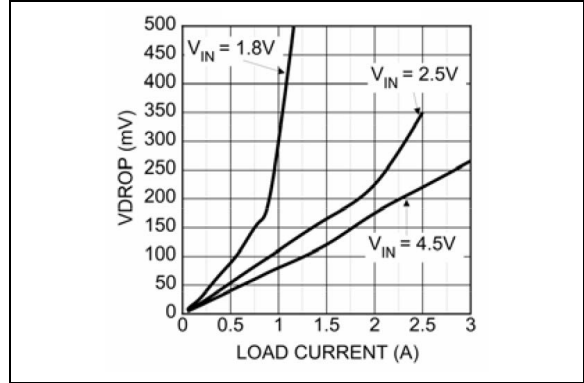
**Note 1:** The maximum allowable power dissipation is a function of ambient temperature, the maximum allowable junction temperature and the thermal resistance from junction to air (i.e.,  $T_A$ ,  $T_J$ ,  $\theta_{JA}$ ). Exceeding the maximum allowable power dissipation will cause the device operating junction temperature to exceed the maximum +125 $^\circ C$  rating. Sustained junction temperatures above +125 $^\circ C$  can impact the device reliability.

## 2.0 TYPICAL PERFORMANCE CURVES

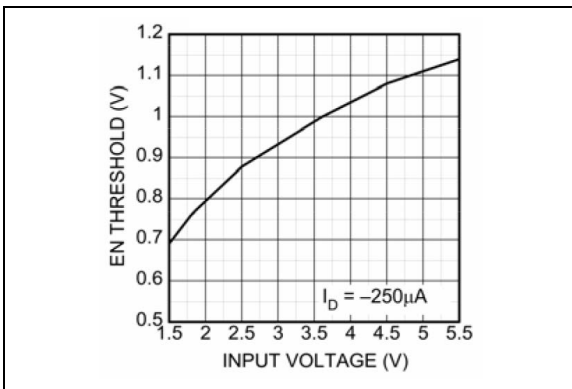
**Note:** The graphs and tables provided following this note are a statistical summary based on a limited number of samples and are provided for informational purposes only. The performance characteristics listed herein are not tested or guaranteed. In some graphs or tables, the data presented may be outside the specified operating range (e.g., outside specified power supply range) and therefore outside the warranted range.



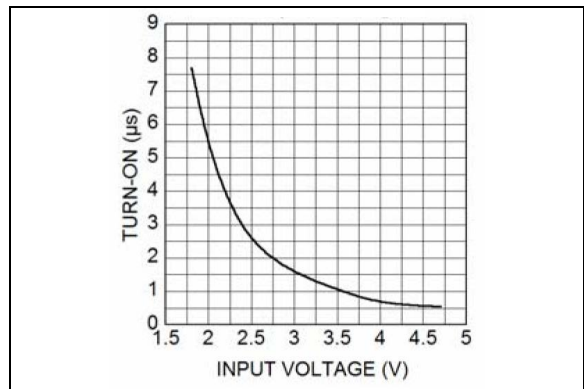
**FIGURE 2-1:**  $R_{DS(ON)}$  Variance with Temperature.



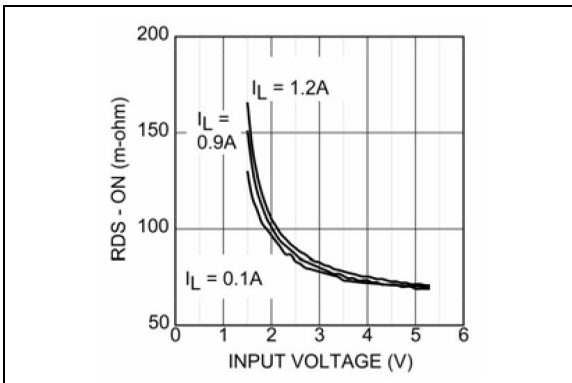
**FIGURE 2-4:** Voltage Drop vs. Load Current.



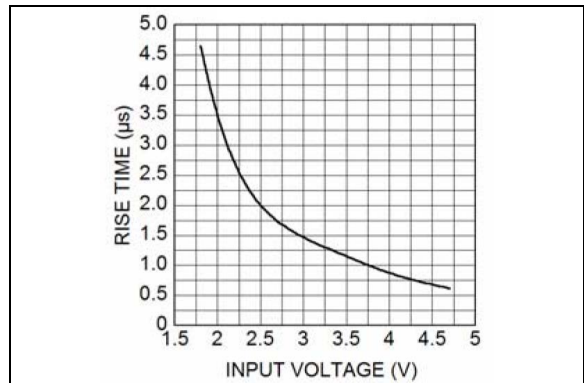
**FIGURE 2-2:** EN Threshold Voltage vs. Input Voltage.



**FIGURE 2-5:** MIC94060/61 Turn-On Delay vs. Input Voltage.

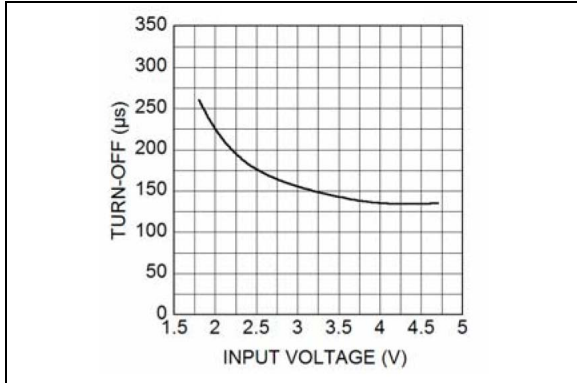


**FIGURE 2-3:** On-Resistance vs. Input Voltage.

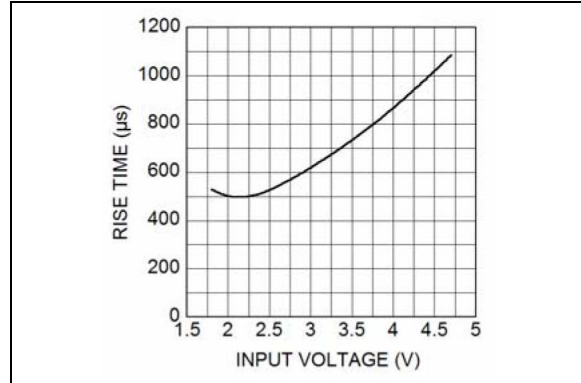


**FIGURE 2-6:** MIC94060/61 Rise Time vs. Input Voltage.

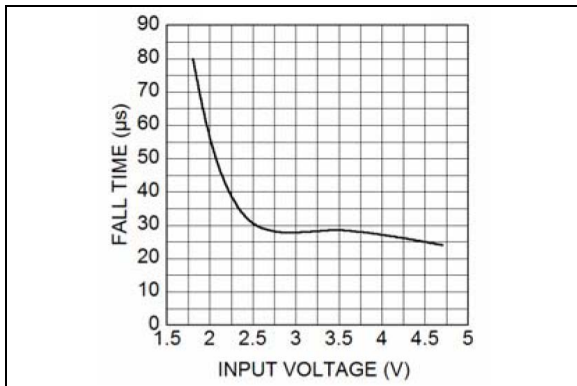
# MIC94060/1/2/3



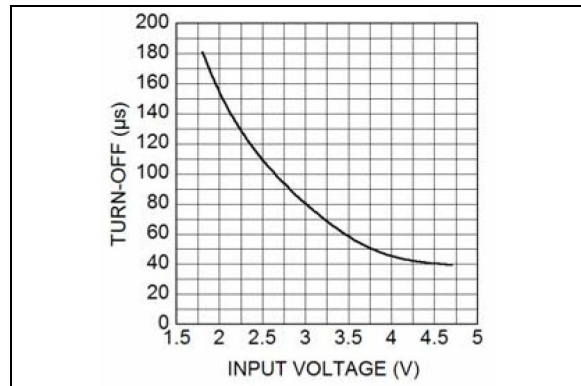
**FIGURE 2-7:** MIC94060/61 Turn-Off Delay vs. Input Voltage.



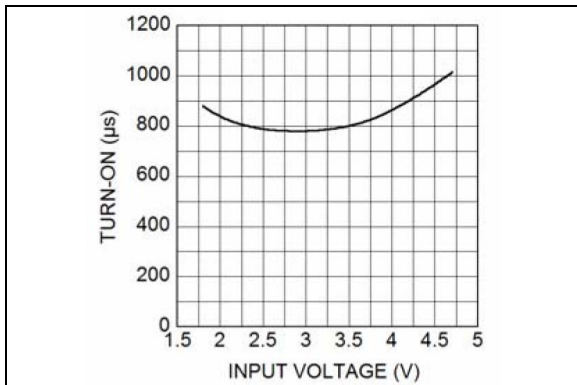
**FIGURE 2-10:** MIC94062/63 Rise Time vs. Input Voltage.



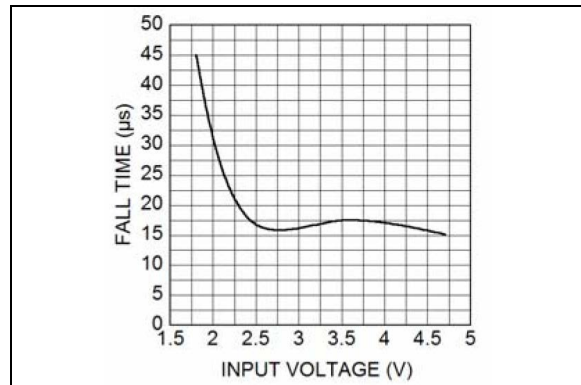
**FIGURE 2-8:** MIC94060/61 Fall Time vs. Input Voltage.



**FIGURE 2-11:** MIC94062/63 Turn-Off Delay vs. Input Voltage.

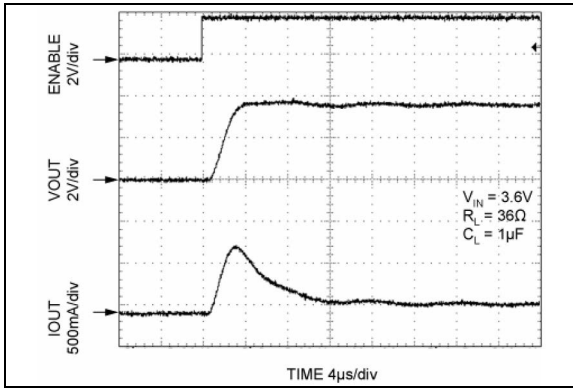


**FIGURE 2-9:** MIC94062/63 Turn-On Delay vs. Input Voltage.

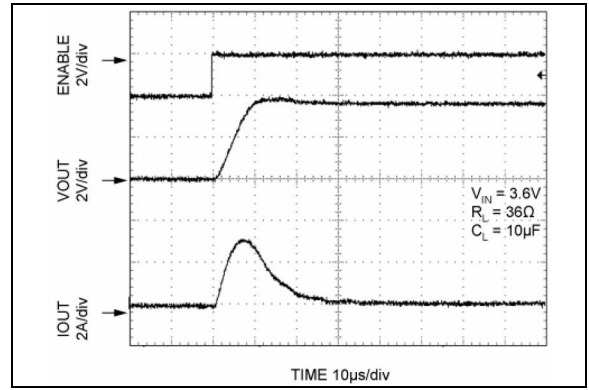


**FIGURE 2-12:** MIC94062/63 Fall Time vs. Input Voltage.

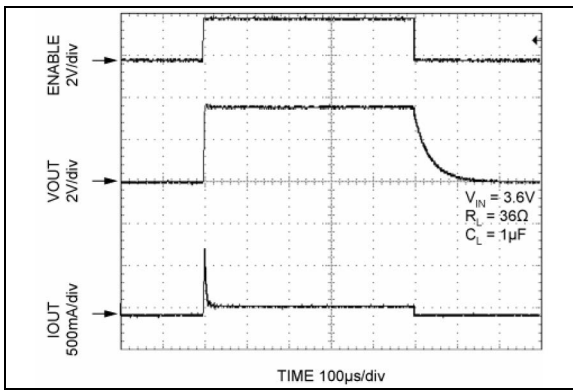
## MIC94060



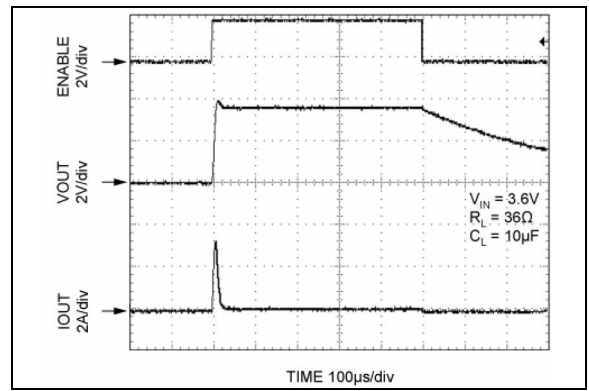
**FIGURE 2-13:** Turn-On/Turn-Off Timing.



**FIGURE 2-15:** Turn-On/Turn-Off Timing.



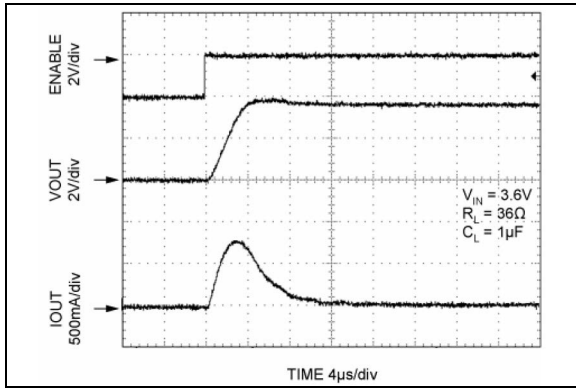
**FIGURE 2-14:** Turn-On/Turn-Off Timing.



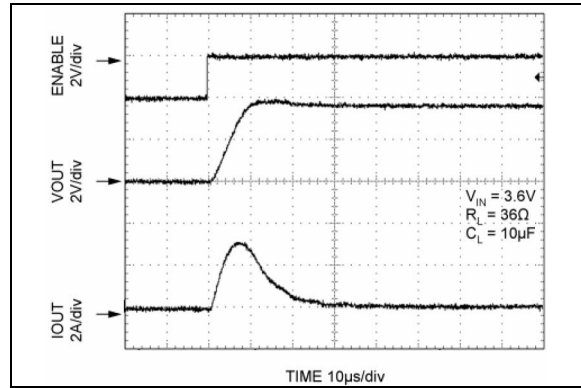
**FIGURE 2-16:** Turn-On/Turn-Off Timing.

# MIC94060/1/2/3

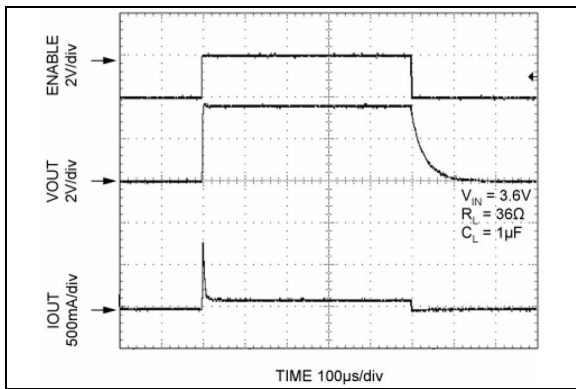
## MIC94061



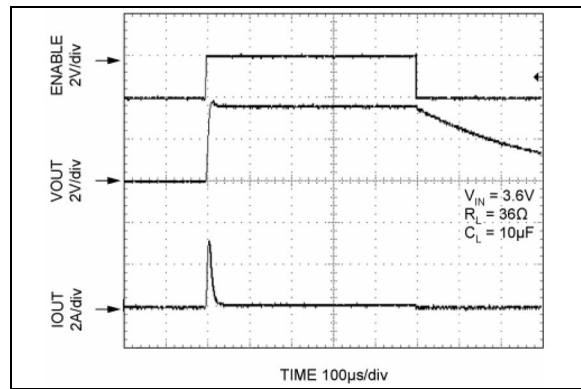
**FIGURE 2-17:** Turn-On/Turn-Off Timing.



**FIGURE 2-19:** Turn-On/Turn-Off Timing.



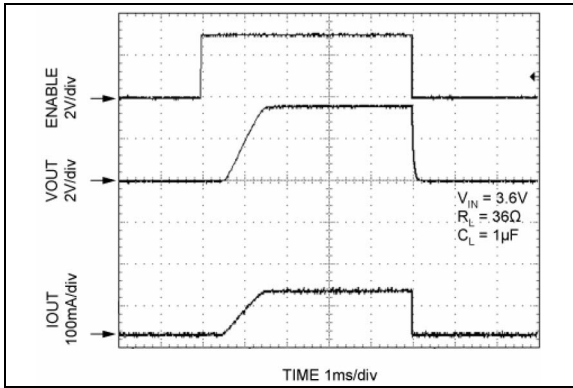
**FIGURE 2-18:** Turn-On/Turn-Off Timing.



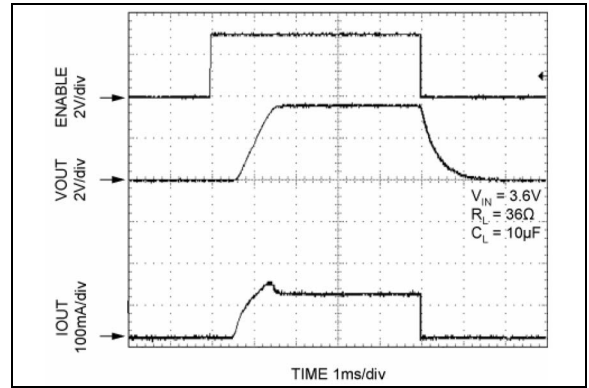
**FIGURE 2-20:** Turn-On/Turn-Off Timing.



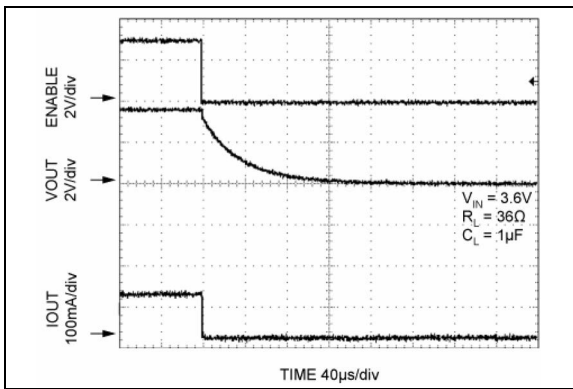
## MIC94062



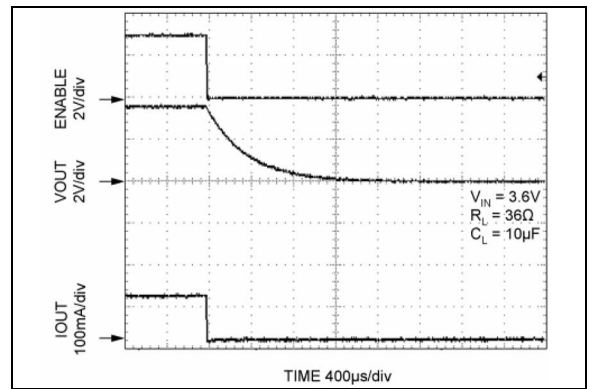
**FIGURE 2-21:** Turn-On/Turn-Off Timing.



**FIGURE 2-23:** Turn-On/Turn-Off Timing.



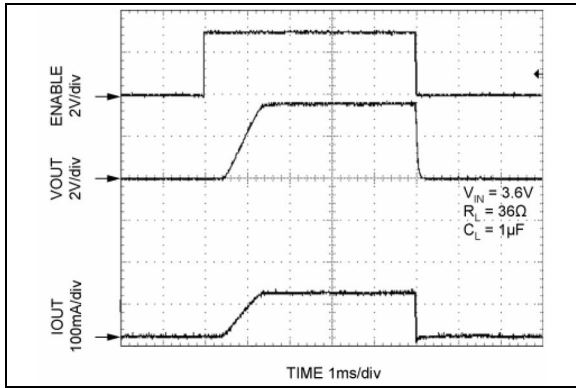
**FIGURE 2-22:** Turn-On/Turn-Off Timing.



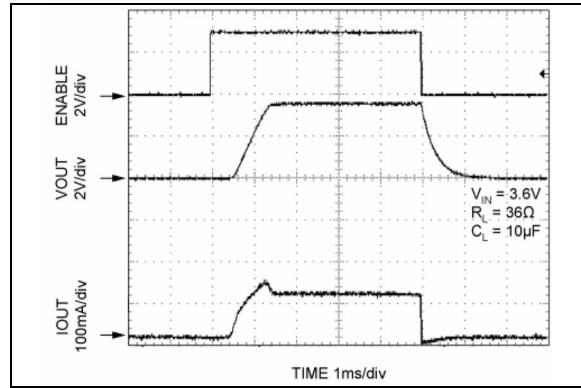
**FIGURE 2-24:** Turn-On/Turn-Off Timing.

# MIC94060/1/2/3

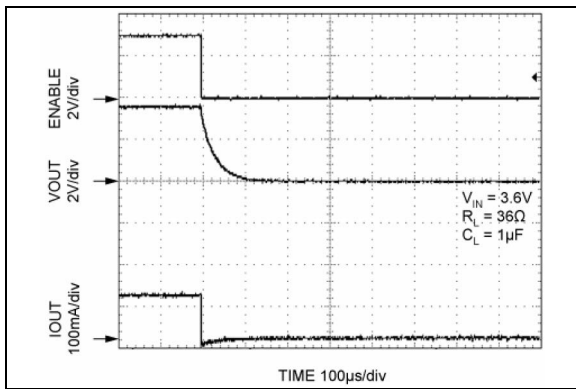
## MIC94063



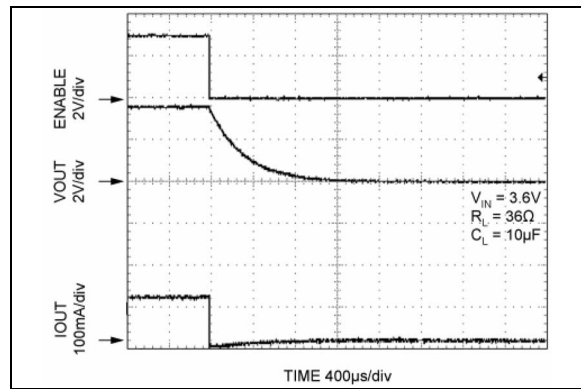
**FIGURE 2-25:** Turn-On/Turn-Off Timing.



**FIGURE 2-27:** Turn-On/Turn-Off Timing.



**FIGURE 2-26:** Turn-On/Turn-Off Timing.



**FIGURE 2-28:** Turn-On/Turn-Off Timing.

## 3.0 PIN DESCRIPTIONS

The descriptions of the pins are listed in [Table 3-1](#).

**TABLE 3-1: PIN FUNCTION TABLE**

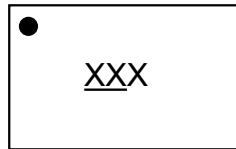
Pin Number SC-70	Pin Number UDFN	Pin Name	Description
1	1	VOUT	Drain of P-channel MOSFET.
2, 5	2	GND	Ground and the backside pad (UDFN only) should both be connected to electrical ground.
4	3	VIN	Source of P-channel MOSFET.
3	4	EN	Enable (Input): Active-high CMOS compatible control input for switch A. Do not leave floating.
6	—	NC	No Internal Connection. A signal or voltage applied to this pin will have no effect on device operation.

# MIC94060/1/2/3

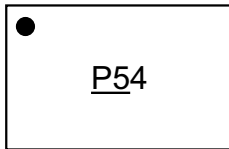
## 4.0 PACKAGING INFORMATION

### 4.1 Package Marking Information

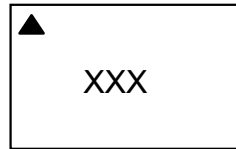
6-Lead SC70\*



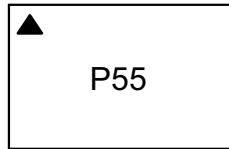
Example



4-Lead UDFN\*



Example

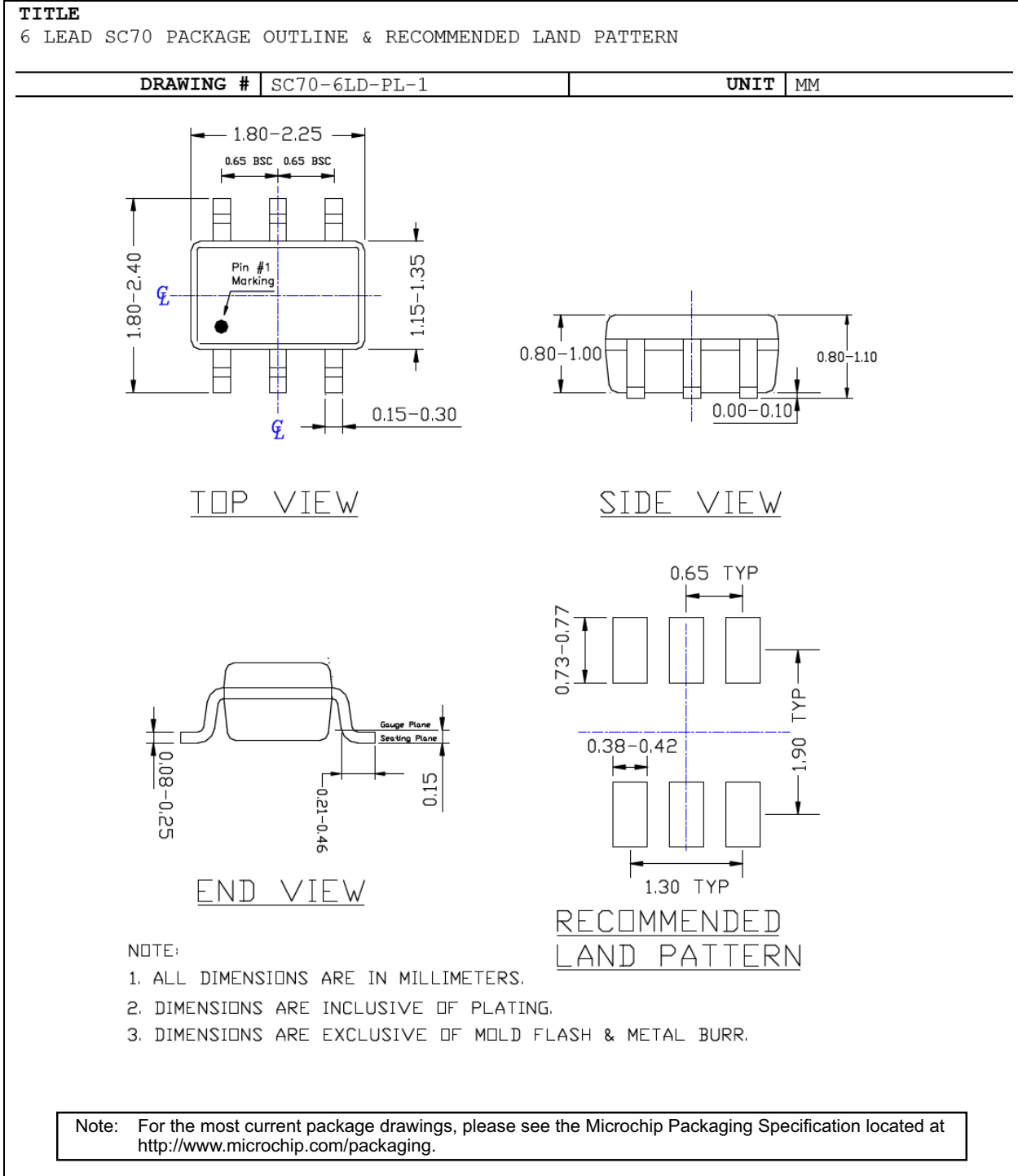


<b>Legend:</b>	XX...X	Product code or customer-specific information
	Y	Year code (last digit of calendar year)
	YY	Year code (last 2 digits of calendar year)
	WW	Week code (week of January 1 is week '01')
	NNN	Alphanumeric traceability code
	(e3)	Pb-free JEDEC® designator for Matte Tin (Sn)
	*	This package is Pb-free. The Pb-free JEDEC designator ((e3)) can be found on the outer packaging for this package.
	•, ▲, ▼	Pin one index is identified by a dot, delta up, or delta down (triangle mark).
<b>Note:</b>	In the event the full Microchip part number cannot be marked on one line, it will be carried over to the next line, thus limiting the number of available characters for customer-specific information. Package may or may not include the corporate logo.	
	Underbar ( ) and/or Overbar ( ) symbol may not be to scale.	

TABLE 4-1: MARKING CODES

Part Number	Marking Code	Soft-Start	Load Discharge
MIC94060YC6	P54	No	No
MIC94061YC6	P55	No	Yes
MIC94062YC6	P56	Yes	No
MIC94063YC6	P57	Yes	Yes
MIC94060YMT	P54	No	No
MIC94061YMT	P55	No	Yes
MIC94062YMT	P56	Yes	No
MIC94063YMT	P57	Yes	Yes

## 6-Lead SC-70 Package Outline & Recommended Land Pattern

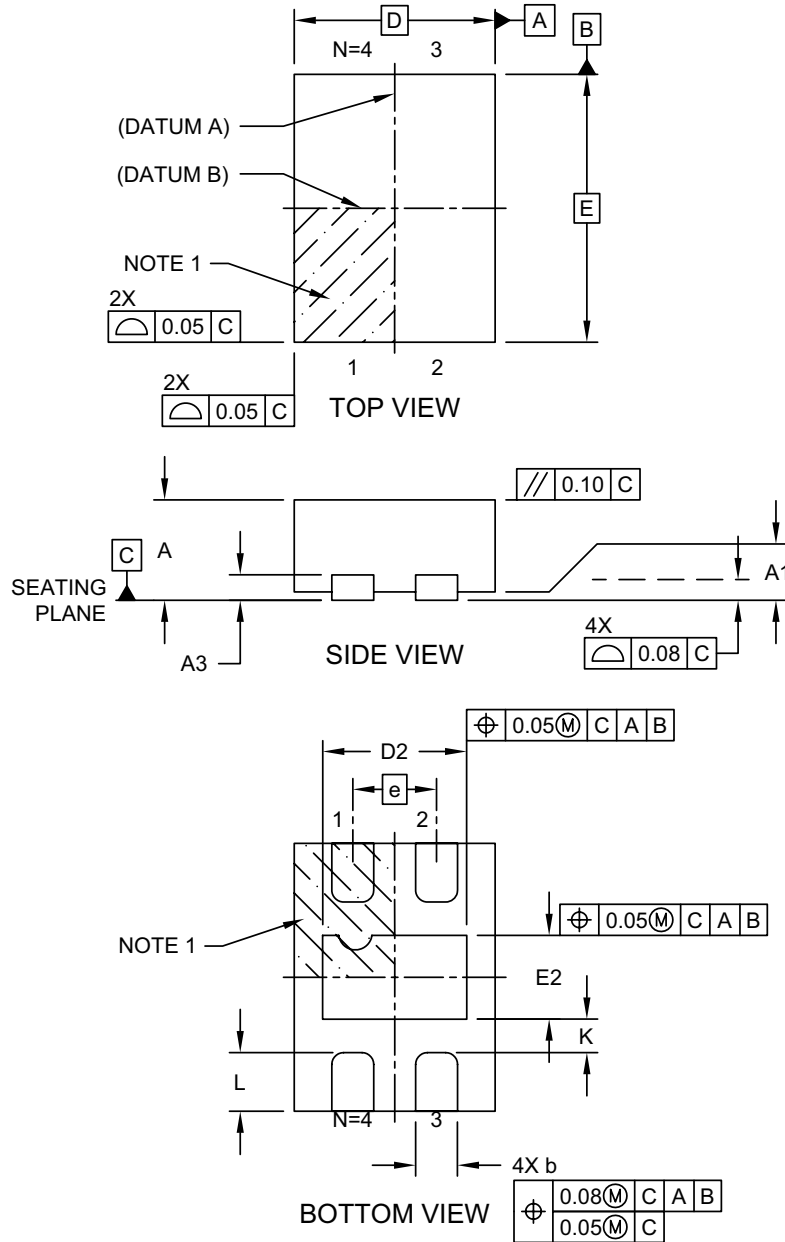


# MIC94060/1/2/3

## 4-Lead UDFN Package Outline and Recommended Land Pattern

### 4-Lead Ultra Thin Dual Flat, No Lead Package (HGA) - 1.2x1.6x0.6 mm Body [UDFN] Micrel Legacy Package TMLF1216D-04L

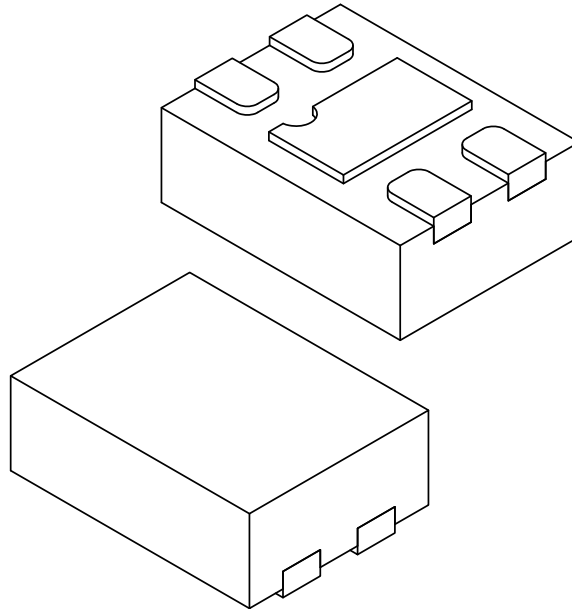
**Note:** For the most current package drawings, please see the Microchip Packaging Specification located at <http://www.microchip.com/packaging>



Microchip Technology Drawing C04-1152 Rev A Sheet 1 of 2

## 4-Lead Ultra Thin Dual Flat, No Lead Package (HGA) - 1.2x1.6x0.6 mm Body [UDFN] Micrel Legacy Package TMLF1216D-04L

**Note:** For the most current package drawings, please see the Microchip Packaging Specification located at <http://www.microchip.com/packaging>



Dimension Limits	Units	MILLIMETERS		
		MIN	NOM	MAX
Number of Terminals	N	4		
Pitch	e	0.50 BSC		
Overall Height	A	0.50	0.55	0.60
Standoff	A1	0.00	0.02	0.05
Terminal Thickness	A3	0.152 REF		
Overall Length	D	1.20 BSC		
Exposed Pad Length	D2	0.81	0.86	0.91
Overall Width	E	1.60 BSC		
Exposed Pad Width	E2	0.45	0.50	0.55
Terminal Width	b	0.20	0.25	0.30
Terminal Length	L	0.30	0.35	0.40
Terminal-to-Exposed-Pad	K	0.20	-	-

**Notes:**

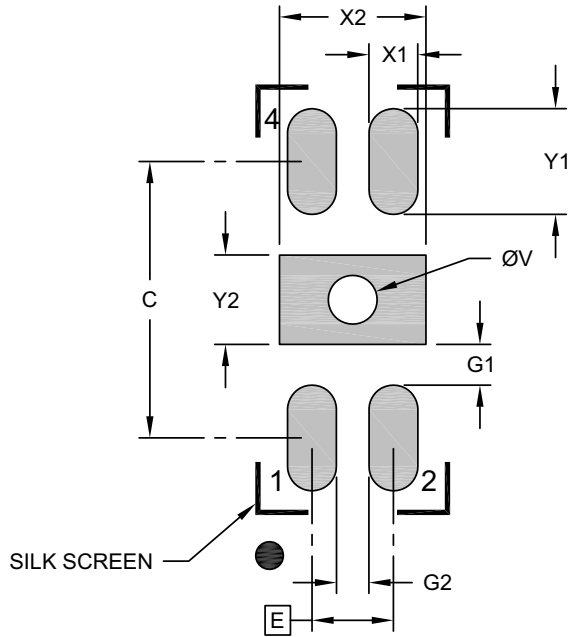
- Pin 1 visual index feature may vary, but must be located within the hatched area.
- Package is saw singulated
- Dimensioning and tolerancing per ASME Y14.5M  
BSC: Basic Dimension. Theoretically exact value shown without tolerances.  
REF: Reference Dimension, usually without tolerance, for information purposes only.

Microchip Technology Drawing C04-1152 Rev A Sheet 2 of 2

# MIC94060/1/2/3

## 4-Lead Ultra Thin Dual Flat, No Lead Package (HGA) - 1.2x1.6x0.6 mm Body [UDFN] Micrel Legacy Package TMLF1216D-04L

**Note:** For the most current package drawings, please see the Microchip Packaging Specification located at <http://www.microchip.com/packaging>



### RECOMMENDED LAND PATTERN

Dimension Limits	Units	MILLIMETERS		
		MIN	NOM	MAX
Contact Pitch	E	0.50 BSC		
Optional Center Pad Width	X2			0.90
Optional Center Pad Length	Y2			0.55
Contact Pad Spacing	C		1.70	
Contact Pad Width (X4)	X1			0.30
Contact Pad Length (X4)	Y1			0.65
Contact Pad to Center Pad (X4)	G1	0.25		
Contact Pad to Contact Pad (X2)	G2	0.20		
Thermal Via Diameter	V		0.30	

**Notes:**

- Dimensioning and tolerancing per ASME Y14.5M  
BSC: Basic Dimension. Theoretically exact value shown without tolerances.
- For best soldering results, thermal vias, if used, should be filled or tented to avoid solder loss during reflow process

Microchip Technology Drawing C04-3152 Rev A



## APPENDIX A: REVISION HISTORY

### Revision A (March 2021)

- Converted Micrel document MIC94060/1/2/3 to Microchip data sheet template DS20006517A.
- Minor grammatical text changes throughout.

### Revision B (January 2022)

- Updated package marking drawing in [Section 4.1, Package Marking Information](#).

# MIC94060/1/2/3

---

---

NOTES:

## PRODUCT IDENTIFICATION SYSTEM

To order or obtain information, e.g., on pricing or delivery, contact your local Microchip representative or sales office.

Device	<u>X</u>	<u>XX</u>	<u>-XX</u>	Examples:
Part No.	Junction Temp. Range	Package	Media Type	
<b>Device:</b>	MIC94060: MIC94061:	High Side Power Switch High Side Power Switch with Load Discharge		a) MIC94060YC6-TR: MIC94060, -40°C to +125°C Temperature Range, 6-Lead SC-70, 3,000/Reel
	MIC94062: MIC94063:	High Side Power Switch with Soft-Start High Side Power Switch with Soft-Start and Load Discharge		b) MIC94061YMT-TR: MIC94061, -40°C to +125°C Temperature Range, 4-Lead UDFN, 5,000/Reel
<b>Junction Temperature Range:</b>	Y =	-40°C to +125°C		c) MIC94062YC6-TR: MIC94062, -40°C to +125°C Temperature Range, 6-Lead SC-70, 3,000/Reel
<b>Package:</b>	C6 = MT =	6-Lead SC-70 4-Lead 1.6 mm x 1.2 mm UDFN		d) MIC94063YMT-TR: MIC94063, -40°C to +125°C Temperature Range, 4-Lead UDFN, 5,000/Reel
<b>Media Type:</b>	TR = TR =	3,000/Reel (SC-70 Package) 5,000/Reel (UDFN Package)		e) MIC94060YMT-TR: MIC94060, -40°C to +125°C Temperature Range, 4-Lead UDFN, 5,000/Reel
				f) MIC94061YC6-TR: MIC94061 -40°C to +125°C Temperature Range, 6-Lead SC-70, 3,000/Reel
				<b>Note 1:</b> Tape and Reel identifier only appears in the catalog part number description. This identifier is used for ordering purposes and is not printed on the device package. Check with your Microchip Sales Office for package availability with the Tape and Reel option.

# MIC94060/1/2/3

---

---

NOTES:

---

---

**Note the following details of the code protection feature on Microchip products:**

- Microchip products meet the specifications contained in their particular Microchip Data Sheet.
- Microchip believes that its family of products is secure when used in the intended manner, within operating specifications, and under normal conditions.
- Microchip values and aggressively protects its intellectual property rights. Attempts to breach the code protection features of Microchip product is strictly prohibited and may violate the Digital Millennium Copyright Act.
- Neither Microchip nor any other semiconductor manufacturer can guarantee the security of its code. Code protection does not mean that we are guaranteeing the product is “unbreakable”. Code protection is constantly evolving. Microchip is committed to continuously improving the code protection features of our products.

---

This publication and the information herein may be used only with Microchip products, including to design, test, and integrate Microchip products with your application. Use of this information in any other manner violates these terms. Information regarding device applications is provided only for your convenience and may be superseded by updates. It is your responsibility to ensure that your application meets with your specifications. Contact your local Microchip sales office for additional support or, obtain additional support at <https://www.microchip.com/en-us/support/design-help/client-support-services>.

THIS INFORMATION IS PROVIDED BY MICROCHIP "AS IS". MICROCHIP MAKES NO REPRESENTATIONS OR WARRANTIES OF ANY KIND WHETHER EXPRESS OR IMPLIED, WRITTEN OR ORAL, STATUTORY OR OTHERWISE, RELATED TO THE INFORMATION INCLUDING BUT NOT LIMITED TO ANY IMPLIED WARRANTIES OF NON-INFRINGEMENT, MERCHANTABILITY, AND FITNESS FOR A PARTICULAR PURPOSE, OR WARRANTIES RELATED TO ITS CONDITION, QUALITY, OR PERFORMANCE.

IN NO EVENT WILL MICROCHIP BE LIABLE FOR ANY INDIRECT, SPECIAL, PUNITIVE, INCIDENTAL, OR CONSEQUENTIAL LOSS, DAMAGE, COST, OR EXPENSE OF ANY KIND WHATSOEVER RELATED TO THE INFORMATION OR ITS USE, HOWEVER CAUSED, EVEN IF MICROCHIP HAS BEEN ADVISED OF THE POSSIBILITY OR THE DAMAGES ARE FORESEEABLE. TO THE FULLEST EXTENT ALLOWED BY LAW, MICROCHIP'S TOTAL LIABILITY ON ALL CLAIMS IN ANY WAY RELATED TO THE INFORMATION OR ITS USE WILL NOT EXCEED THE AMOUNT OF FEES, IF ANY, THAT YOU HAVE PAID DIRECTLY TO MICROCHIP FOR THE INFORMATION.

Use of Microchip devices in life support and/or safety applications is entirely at the buyer's risk, and the buyer agrees to defend, indemnify and hold harmless Microchip from any and all damages, claims, suits, or expenses resulting from such use. No licenses are conveyed, implicitly or otherwise, under any Microchip intellectual property rights unless otherwise stated.

For information regarding Microchip's Quality Management Systems, please visit [www.microchip.com/quality](http://www.microchip.com/quality).

**Trademarks**

The Microchip name and logo, the Microchip logo, Adaptec, AnyRate, AVR, AVR logo, AVR Freaks, BesTime, BitCloud, CryptoMemory, CryptoRF, dsPIC, flexPWR, HELDO, IGLOO, JukeBlox, KeeLoq, Klear, LANCheck, LinkMD, maXStylus, maXTouch, MediaLB, megaAVR, Microsemi, Microsemi logo, MOST, MOST logo, MPLAB, OptoLyzer, PIC, picoPower, PICSTART, PIC32 logo, PolarFire, Prochip Designer, QTouch, SAM-BA, SenGenuity, SpyNIC, SST, SST Logo, SuperFlash, Symmetricom, SyncServer, Tachyon, TimeSource, tinyAVR, UNI/O, Vectron, and XMEGA are registered trademarks of Microchip Technology Incorporated in the U.S.A. and other countries.

AgileSwitch, APT, ClockWorks, The Embedded Control Solutions Company, EtherSynch, Flashtec, Hyper Speed Control, HyperLight Load, IntelliMOS, Libero, motorBench, mTouch, Powermite 3, Precision Edge, ProASIC, ProASIC Plus, ProASIC Plus logo, QuietWire, SmartFusion, SyncWorld, Temux, TimeCesium, TimeHub, TimePictra, TimeProvider, TrueTime, WinPath, and ZL are registered trademarks of Microchip Technology Incorporated in the U.S.A.

Adjacent Key Suppression, AKS, Analog-for-the-Digital Age, Any Capacitor, AnyIn, AnyOut, Augmented Switching, BlueSky, BodyCom, CodeGuard, CryptoAuthentication, CryptoAutomotive, CryptoCompanion, CryptoController, dsPICDEM, dsPICDEM.net, Dynamic Average Matching, DAM, ECAN, Espresso T1S, EtherGREEN, GridTime, IdealBridge, In-Circuit Serial Programming, ICSP, INICnet, Intelligent Paralleling, Inter-Chip Connectivity, JitterBlocker, Knob-on-Display, maxCrypto, maxView, memBrain, Mindi, MiWi, MPASM, MPF, MPLAB Certified logo, MPLIB, MPLINK, MultiTRAK, NetDetach, NVM Express, NVMe, Omniscient Code Generation, PICDEM, PICDEM.net, PICKit, PICtail, PowerSmart, PureSilicon, QMatrix, REAL ICE, Ripple Blocker, RTAX, RTG4, SAM-ICE, Serial Quad I/O, simpleMAP, SimpliPHY, SmartBuffer, SmartHLS, SMART-I.S., storClad, SQL, SuperSwitcher, SuperSwitcher II, Switchtec, SynchroPHY, Total Endurance, TSHARC, USBCheck, VariSense, VectorBlox, VeriPHY, ViewSpan, WiperLock, XpressConnect, and ZENA are trademarks of Microchip Technology Incorporated in the U.S.A. and other countries.

SQTP is a service mark of Microchip Technology Incorporated in the U.S.A.

The Adaptec logo, Frequency on Demand, Silicon Storage Technology, Symmcom, and Trusted Time are registered trademarks of Microchip Technology Inc. in other countries.

GestIC is a registered trademark of Microchip Technology Germany II GmbH & Co. KG, a subsidiary of Microchip Technology Inc., in other countries.

All other trademarks mentioned herein are property of their respective companies.

© 2016 - 2021 - 2022, Microchip Technology Incorporated and its subsidiaries.

All Rights Reserved.

ISBN: 978-1-5224-9577-2



# MICROCHIP

## Worldwide Sales and Service

### AMERICAS

**Corporate Office**  
2355 West Chandler Blvd.  
Chandler, AZ 85224-6199  
Tel: 480-792-7200  
Fax: 480-792-7277  
Technical Support:  
<http://www.microchip.com/support>  
Web Address:  
[www.microchip.com](http://www.microchip.com)

**Atlanta**  
Duluth, GA  
Tel: 678-957-9614  
Fax: 678-957-1455

**Austin, TX**  
Tel: 512-257-3370

**Boston**  
Westborough, MA  
Tel: 774-760-0087  
Fax: 774-760-0088

**Chicago**  
Itasca, IL  
Tel: 630-285-0071  
Fax: 630-285-0075

**Dallas**  
Addison, TX  
Tel: 972-818-7423  
Fax: 972-818-2924

**Detroit**  
Novi, MI  
Tel: 248-848-4000

**Houston, TX**  
Tel: 281-894-5983

**Indianapolis**  
Noblesville, IN  
Tel: 317-773-8323  
Fax: 317-773-5453  
Tel: 317-536-2380

**Los Angeles**  
Mission Viejo, CA  
Tel: 949-462-9523  
Fax: 949-462-9608  
Tel: 951-273-7800

**Raleigh, NC**  
Tel: 919-844-7510

**New York, NY**  
Tel: 631-435-6000

**San Jose, CA**  
Tel: 408-735-9110  
Tel: 408-436-4270

**Canada - Toronto**  
Tel: 905-695-1980  
Fax: 905-695-2078

### ASIA/PACIFIC

**Australia - Sydney**  
Tel: 61-2-9868-6733

**China - Beijing**  
Tel: 86-10-8569-7000

**China - Chengdu**  
Tel: 86-28-8665-5511

**China - Chongqing**  
Tel: 86-23-8980-9588

**China - Dongguan**  
Tel: 86-769-8702-9880

**China - Guangzhou**  
Tel: 86-20-8755-8029

**China - Hangzhou**  
Tel: 86-571-8792-8115

**China - Hong Kong SAR**  
Tel: 852-2943-5100

**China - Nanjing**  
Tel: 86-25-8473-2460

**China - Qingdao**  
Tel: 86-532-8502-7355

**China - Shanghai**  
Tel: 86-21-3326-8000

**China - Shenyang**  
Tel: 86-24-2334-2829

**China - Shenzhen**  
Tel: 86-755-8864-2200

**China - Suzhou**  
Tel: 86-186-6233-1526

**China - Wuhan**  
Tel: 86-27-5980-5300

**China - Xian**  
Tel: 86-29-8833-7252

**China - Xiamen**  
Tel: 86-592-2388138

**China - Zhuhai**  
Tel: 86-756-3210040

### ASIA/PACIFIC

**India - Bangalore**  
Tel: 91-80-3090-4444

**India - New Delhi**  
Tel: 91-11-4160-8631

**India - Pune**  
Tel: 91-20-4121-0141

**Japan - Osaka**  
Tel: 81-6-6152-7160

**Japan - Tokyo**  
Tel: 81-3-6880-3770

**Korea - Daegu**  
Tel: 82-53-744-4301

**Korea - Seoul**  
Tel: 82-2-554-7200

**Malaysia - Kuala Lumpur**  
Tel: 60-3-7651-7906

**Malaysia - Penang**  
Tel: 60-4-227-8870

**Philippines - Manila**  
Tel: 63-2-634-9065

**Singapore**  
Tel: 65-6334-8870

**Taiwan - Hsin Chu**  
Tel: 886-3-577-8366

**Taiwan - Kaohsiung**  
Tel: 886-7-213-7830

**Taiwan - Taipei**  
Tel: 886-2-2508-8600

**Thailand - Bangkok**  
Tel: 66-2-694-1351

**Vietnam - Ho Chi Minh**  
Tel: 84-28-5448-2100

### EUROPE

**Austria - Wels**  
Tel: 43-7242-2244-39  
Fax: 43-7242-2244-393

**Denmark - Copenhagen**  
Tel: 45-4485-5910  
Fax: 45-4485-2829

**Finland - Espoo**  
Tel: 358-9-4520-820

**France - Paris**  
Tel: 33-1-69-53-63-20  
Fax: 33-1-69-30-90-79

**Germany - Garching**  
Tel: 49-8931-9700

**Germany - Haan**  
Tel: 49-2129-3766400

**Germany - Heilbronn**  
Tel: 49-7131-72400

**Germany - Karlsruhe**  
Tel: 49-721-625370

**Germany - Munich**  
Tel: 49-89-627-144-0  
Fax: 49-89-627-144-44

**Germany - Rosenheim**  
Tel: 49-8031-354-560

**Israel - Ra'anana**  
Tel: 972-9-744-7705

**Italy - Milan**  
Tel: 39-0331-742611  
Fax: 39-0331-466781

**Italy - Padova**  
Tel: 39-049-7625286

**Netherlands - Drunen**  
Tel: 31-416-690399  
Fax: 31-416-690340

**Norway - Trondheim**  
Tel: 47-7288-4388

**Poland - Warsaw**  
Tel: 48-22-3325737

**Romania - Bucharest**  
Tel: 40-21-407-87-50

**Spain - Madrid**  
Tel: 34-91-708-08-90  
Fax: 34-91-708-08-91

**Sweden - Gothenberg**  
Tel: 46-31-704-60-40

**Sweden - Stockholm**  
Tel: 46-8-5090-4654

**UK - Wokingham**  
Tel: 44-118-921-5800  
Fax: 44-118-921-5820