

SKF Explorer spherical roller bearings

Optimized for superior field performance

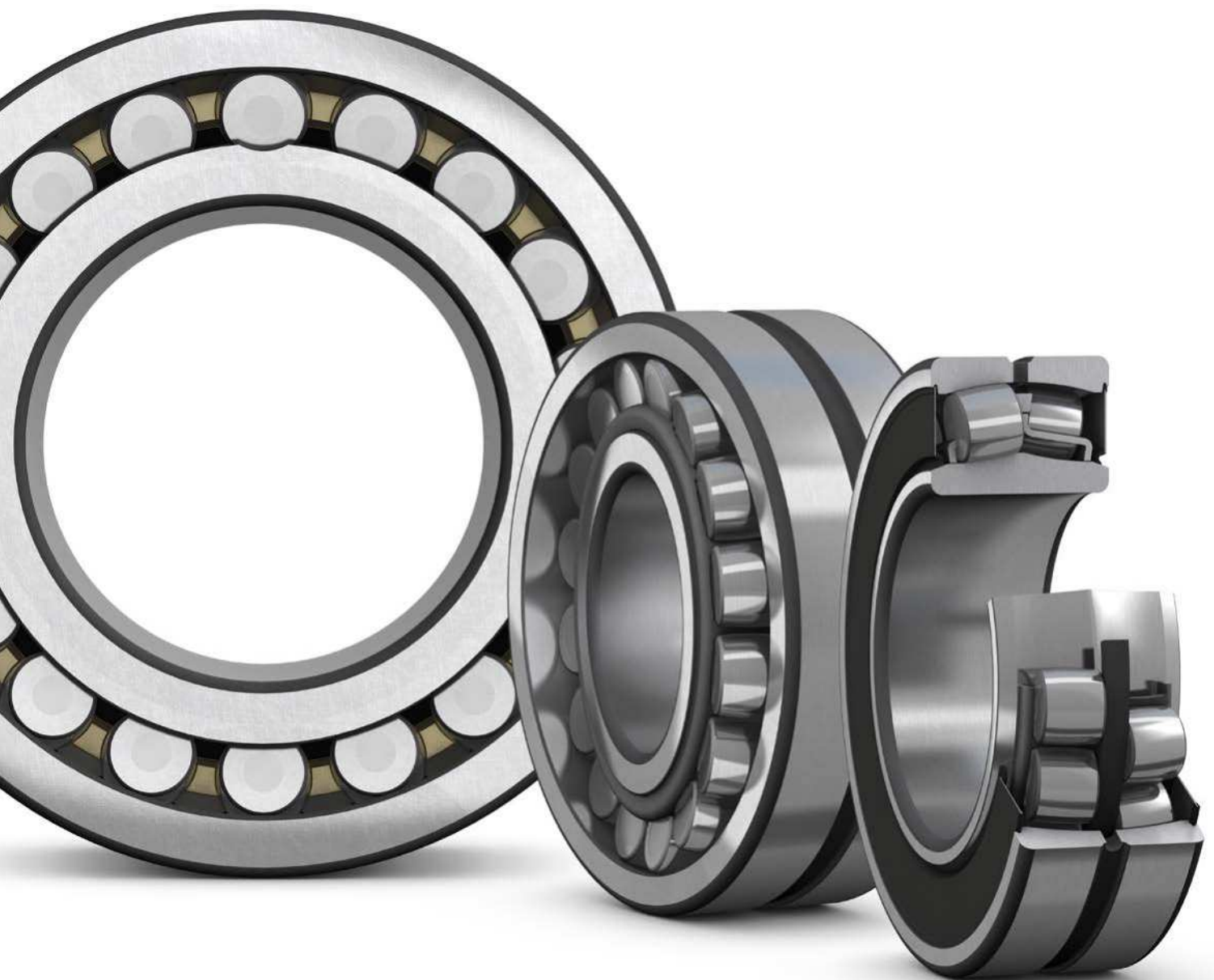



Continuous improvement to optimize



The timeline below illustrates SKF milestones in the development of self-aligning bearings.

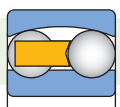

1907

SKF invents the self-aligning ball bearing

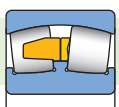

1919

SKF invents the spherical roller bearing



1933

SKF invents the spherical roller thrust bearing

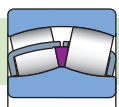

1951

SKF introduces the C design with a guide ring

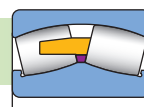

1954

SKF introduces the CA design

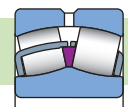

1979

SKF introduces the CC and CAC designs with self-guiding rollers

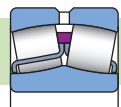
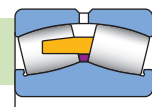

1989

SKF introduces the E design, with increased load carrying capacity



bearing performance in the field

With many innovations and refinements over the decades, noted in the timeline below, SKF spherical roller bearings have continuously raised the performance bar. Improvements in steel composition, heat treatment, geometries, surface finishes and lubrication are the ingredients of an upgraded SKF Explorer spherical roller bearing. This enables up to twice the service life compared to the previous SKF Explorer performance.

As they have since the beginning, SKF Explorer spherical roller bearings continue to set the industry standard. And today we offer the widest range of spherical roller bearings in the industry, both open and sealed.

Whatever your application, you will appreciate that every SKF spherical roller bearing has been optimized to deliver superior field performance and a healthier bottom line.

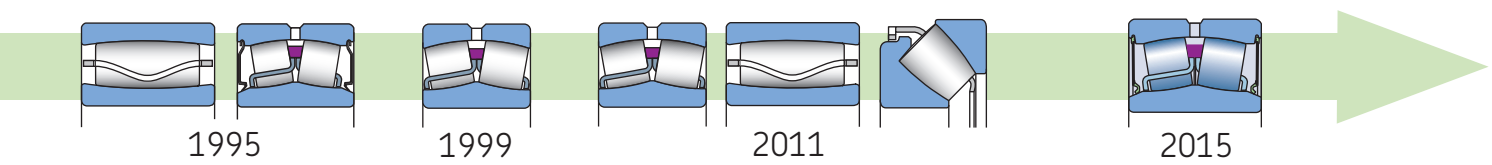

1995

1999

2011

2015

SKF introduces the CARB toroidal roller bearing and a standard range of sealed spherical roller bearings

SKF introduces SKF Explorer spherical roller bearings

SKF introduces upgraded SKF Explorer bearings featuring a new heat treatment to extend service life

SKF introduces sealed spherical roller bearings with improved performance

Designing bearings for superior performance in the field



Understanding and addressing the factors that cause bearing failure is critical to designing bearings that can perform as expected under field conditions. For decades, SKF has worked with design engineers to

improve machine reliability, leading the way with robust bearing designs that have virtually eliminated bearing failure due to sub-surface fatigue.

In fact, SKF experience has confirmed that today's high quality bearings rarely fail because of sub-surface fatigue damage. If a bearing fails as a result of surface damage, it is generally caused by factors such as contamination, inadequate lubrication, surface distress and wear. Beside these factors, moisture, corrosion, electric current erosion and fracture can occur.

Drawing on the substantial progress made in the surface life modelling area, SKF has now successfully integrated this knowledge into a new rolling bearing life calculation, called the SKF Generalized Bearing Life Model. This new model builds on the strengths of the current bearing life model – also developed by SKF over 30 years ago – by successfully separating surface failure modes from sub-surface failure modes.

It also factors in additional parameters, including lubrication, contamination and surface distress. By accounting for more failure modes, the model has the potential to more accurately predict bearing behaviour in real-world operating conditions.

SKF is also using the application knowledge that went into creating the new model to develop more advanced calculation tools that will enable our customers to make more informed bearing choices.

Another benefit of the new model is the flexible “framework” that can easily integrate new tribology – and material science knowledge. As bearing science evolves, so will the model.

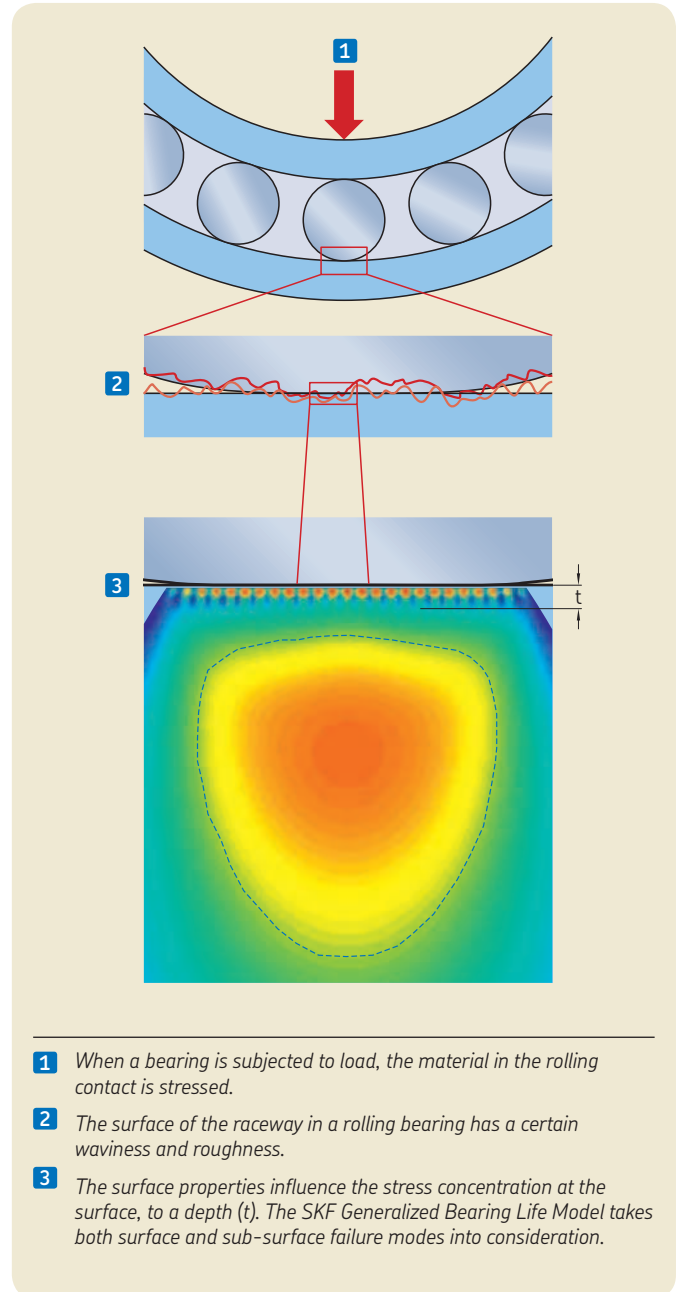

A commitment to innovation and improved bearing performance

From the very start, SKF has taken the lead in the development of self-aligning bearings. We introduced spherical roller bearings in 1919 and have been consistently improving them. Along the way, we also invented the spherical roller thrust bearings and CARB toroidal roller bearings.

In 1999, we introduced the SKF Explorer performance class with improvements in bearing geometry, materials and manufacturing methods. SKF Explorer bearings gave design and maintenance engineers a whole new set of options. Machinery could be downsized with no loss of capacity, or run faster, longer, cooler or quieter.

Today, all spherical roller bearings are in the SKF Explorer performance class and have been upgraded, featuring a combination of high-quality steel and an improved heat treatment process. Upgraded SKF Explorer spherical roller bearings are marked with “WR” on the package and the bearing outer ring.

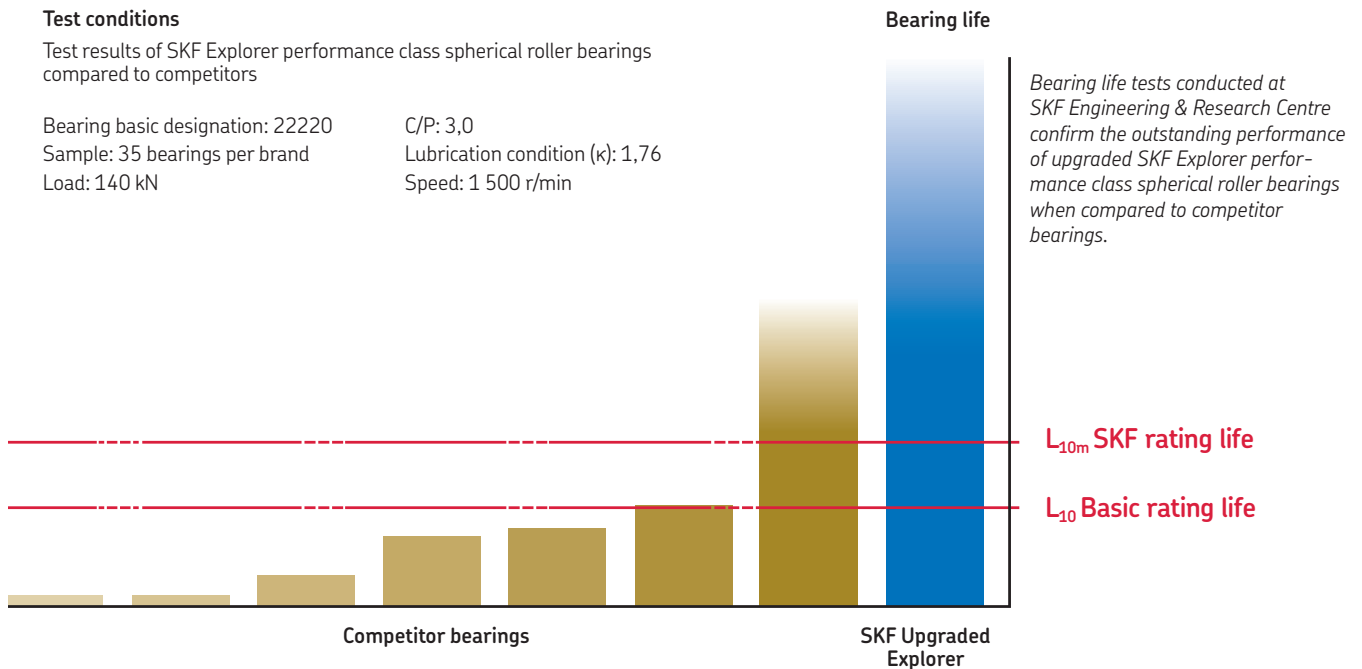

Unique features of upgraded open and sealed SKF spherical roller bearings

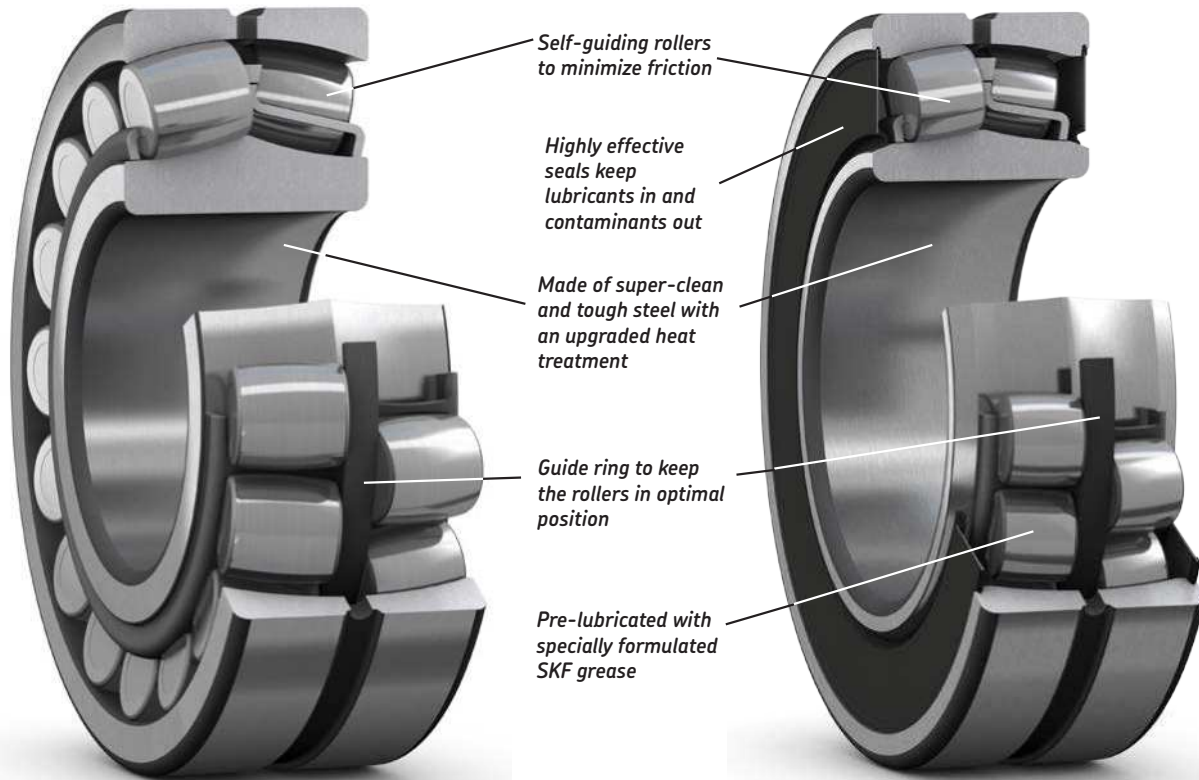

Tests conducted in SKF laboratories show that upgraded SKF Explorer spherical roller bearings can last up to twice as long as previous generation bearings when operating under contaminated or poor lubrication conditions.

Test conditions

Bearings: 22220 E
The bearings were run-in under contaminated conditions.
 $c = 0,2$

Operating conditions after cleaning
Load: 140 kN
C/P: 3,0
Speed: 1 500 r/min
Lubricant: Turbo T 68 mineral oil
: 2,1

Relative service life

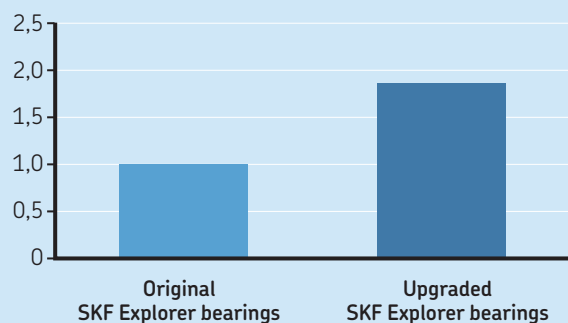

Test conditions

Bearings: 22220 E
Load: 140 kN
Speed: 1 500 r/min

Lubricant: Turbo T 9 mineral oil
: 0,45
Operating temperature = 75 °C

Relative service life

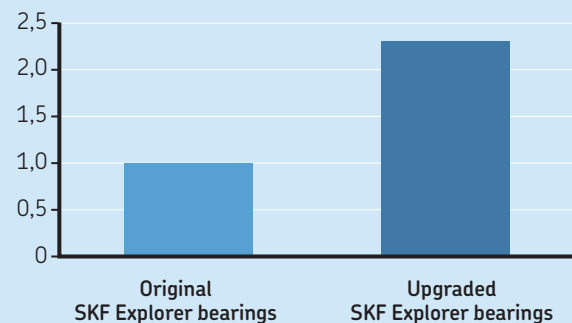

The SKF Engineering & Research Centre performed endurance tests under specific conditions of contamination and poor lubrication to verify performance improvements of the upgraded SKF Explorer bearings.

Proven success in many industries and applications



Common applications

- Gearboxes
- Wind turbines
- Pumps
- Fans and blowers
- Mining and construction equipment
- Pulp and paper processing equipment
- Marine and offshore machinery
- Metal industry equipment
- Railway axle boxes



Customer: Benzlers Drives

“Our customers require 80 000 hours of service life. I need to have bearings with performance that I can trust.”

*Wolfgang Böhm
Application engineering manager*

Sealed bearings for superior protection against contaminants

Less maintenance, longer life

Sealed SKF Explorer spherical roller bearings can significantly increase bearing service life in contaminated environments.

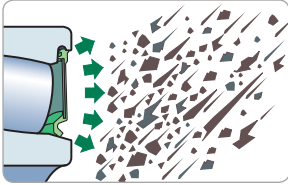

These bearings are pre-lubricated with a specially formulated grease and sealed with highly effective contact seals. The seals protect the bearing and lubricant from contaminants that might

otherwise cause premature bearing failure.

In many applications, these bearings can be considered lubricated for the life of the bearing. By eliminating or extending relubrication intervals, these bearings can significantly reduce the cost to purchase, apply and dispose of grease. Reduced maintenance costs will, in many cases, substantially reduce the total cost of ownership of an application.



The rating life of a sealed spherical roller bearing can be up to four times the rating life of an open spherical roller bearing in a typically contaminated environment.

Due to the cleanliness of a sealed SKF spherical roller bearing, changing from an open to a sealed design makes it possible to increase bearing rating life by up to four times in the contaminated environments of typical heavy industrial applications.

Benefits include:

- Significantly reduced need for maintenance
- Minimized grease consumption and environmental impact
- Substantially increased uptime
- Longer bearing life

Small sealed SKF spherical roller bearings with improved performance

Half the friction, twice the speed

With a new design that results in up to 50% less seal friction, SKF's small sealed spherical roller bearings (shown in blue colour in **diagram 2**) reduce operating temperatures by as much as 20 °C (36 °F) (→ **diagram 1**), enabling us to double the limiting speed rating. As a result, more applications can benefit from the superior contamination protection of sealed SKF spherical roller bearings.

Sealed spherical roller bearings are suitable for a wide range of applications including elevators, off-highway and agricultural machinery, fans and fluid machinery, food and beverage equipment, conveyors and some small electric motors.

Additional benefits:

- Total bearing friction reduced by as much as 20%
- Relubrication intervals can be up to twice as long
- Grease usage can be reduced significantly
- In many applications the bearing can be considered relubrication-free for the life of the bearing, reducing maintenance costs

Diagram 1

Sealed SKF spherical roller bearing operating temperature

Test conditions: Speed: 900 r/min and 1 200 r/min
 Bearings: 23022-2CS/VT143 and 23022-2RS/VT143 Temperature measured on outer ring
 Load: C/P = 10, pure radial load

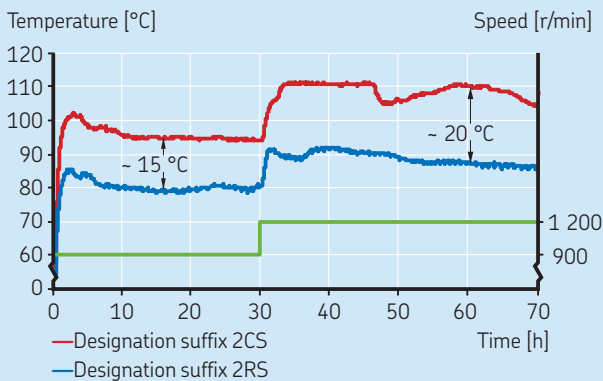

The reduced seal friction of the bearings with improved performance (designation suffix RS) results in lower operating temperature, enabling extended relubrication intervals.

Diagram 2

Sealed SKF spherical roller bearing range

[mm] Series	Series									Size
	213	222	223	230	231	232	239	240	241	
25	↔									05
30	↔									06
35	↔									07
40	↔	↔								08
45	↔	↔								09
50	↔	↔								10
55	↔	↔								11
60	↔	↔								12
65	↔	↔								13
70	↔	↔								14
75	↔	↔								15
80	↔	↔								16
85	↔	↔								17
90	↔	↔								18
95	↔	↔								19
100	↔	↔								20
110	↔	↔								22
120	↔	↔								24
130	↔	↔								26
140										28
150										30
160										32
170										34
180										36
190										38
200										40
220										44
240										48
260										52
280										56
300										60
320										64
340										68
360							1)			72
380										76
400										80
420							1)			84
440										88
460							1)			92

- Light green square = Open spherical roller bearings available
- Dark green square = Open and sealed spherical roller bearings available, designation suffix 2CS
- Blue square = Open and sealed spherical roller bearings available, designation suffix 2RS
- ↔ = Sealed bearing is slightly wider than open bearing

1) Can be delivered with some restrictions, please contact your sales representative.

The SKF range of sealed spherical roller bearings is the widest among all manufacturers.

Bearings for specific applications

SKF spherical roller bearings for vibratory applications

SKF offers spherical roller bearings specifically designed to withstand high acceleration levels. The bearings are equipped with a special, hardened cage and a hardened guide ring, which enable them to withstand higher acceleration forces while operating at cooler temperatures. These bearings have been used with great success in vibratory applications such as vibrating screens and road rollers.

SKF Explorer bearings for vibratory applications are also available with a PTFE coated bore to virtually eliminate fretting corrosion at the non-locating bearing position. Available sizes: 22308-22348



Solid Oil bearings

Solid Oil bearings are designed for relubrication-free operation and are ideal for industries such as marine, oil and gas and port cranes where the bearings are often weather exposed and operate in wet environments. These bearings are lubricated with oil encapsulated in a polymer. During operation, the oil is continuously released to lubricate the bearing. Solid Oil bearings may operate in temperatures of up to 85 °C (185 °F) and at moderate speeds.

Virtually any SKF spherical roller bearing can be supplied on request as a Solid Oil bearing.



SKF self-aligning bearing system

In the past, applications that had to contend with misalignment and thermal elongation of the shaft used a locating/non-locating bearing arrangement with two spherical roller bearings. The non-locating bearing would have a loose outer ring fit, enabling it to slide on its seat in the housing. This arrangement typically caused a stick-slip condition which induced vibrations, additional axial loads on the bearings and heat – all of which can significantly reduce bearing service life.

The SKF self-aligning bearing system, which uses a spherical roller bearing at the locating position and a CARB toroidal roller bearing in the non-locating position, virtually eliminates those problems.

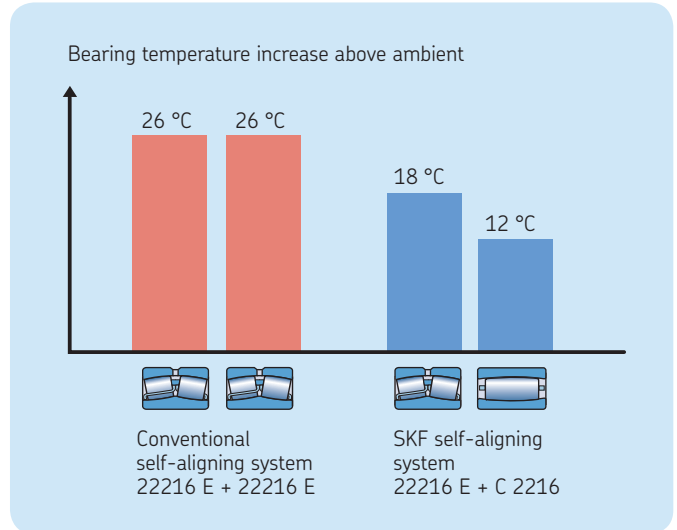

The temperature of the bearings was significantly reduced by the SKF self-aligning system, which includes an SKF spherical roller bearing and a CARB bearing. Reducing the operating temperature extends the relubrication interval.

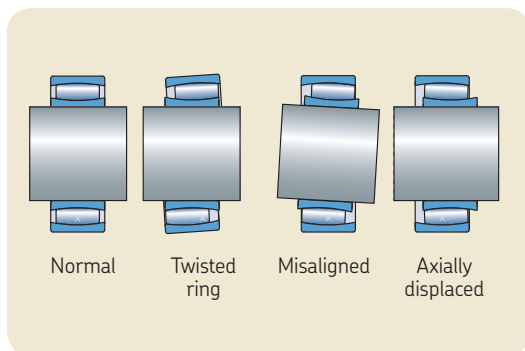
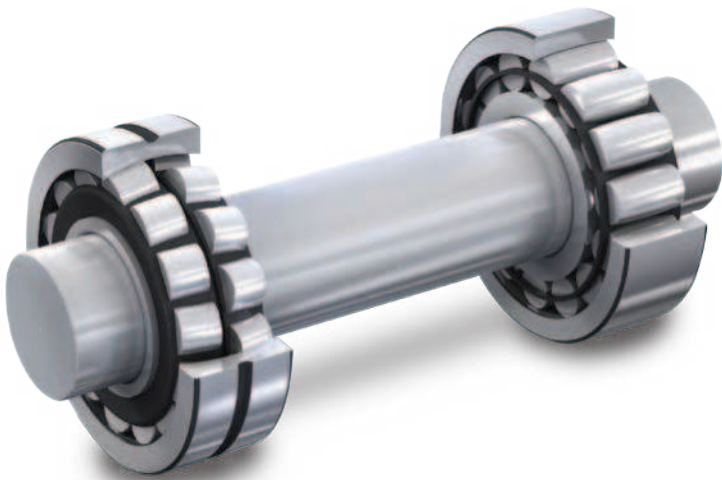

The rollers in a CARB toroidal roller bearing adjust automatically so that the load is distributed evenly along their entire length.

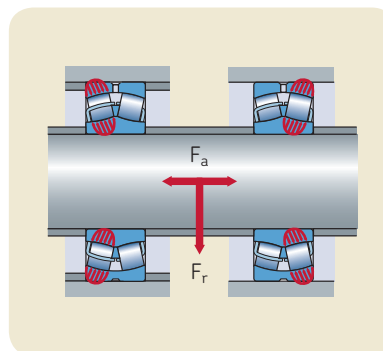

Heavy axial loads and stresses are induced in the bearings system if the non-locating bearing experiences "stick-slip" or is restricted from moving axially.

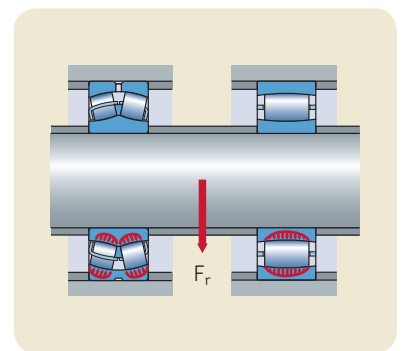

By virtually eliminating induced axial loads, both bearings can share existing loads equally.

For more information about SKF Explorer bearings,
see your SKF representative or visit skf.com/srb

© SKF, SKF Explorer and CARB are registered trademarks of the SKF Group.

© SKF Group 2016

The contents of this publication are the copyright of the publisher and may not be reproduced (even extracts) unless prior written permission is granted. Every care has been taken to ensure the accuracy of the information contained in this publication but no liability can be accepted for any loss or damage whether direct, indirect or consequential arising out of the use of the information contained herein.

PUB BU/P2 15500/3 EN · November 2016

Certain image(s) used under license from Shutterstock.com



SKF®