

### Features

- Mounts flush with panel.
- Low power consumption.
- Suitable for audio panel indicator.
- Fits 2mm hole in panel up to 3.5mm (.138").
- Long life - solid state reliability.
- RoHS compliant.

### Description

The High Efficiency Red source color devices are made with Gallium Arsenide Phosphide on Gallium Phosphide Orange Light Emitting Diode.

### Package Dimensions

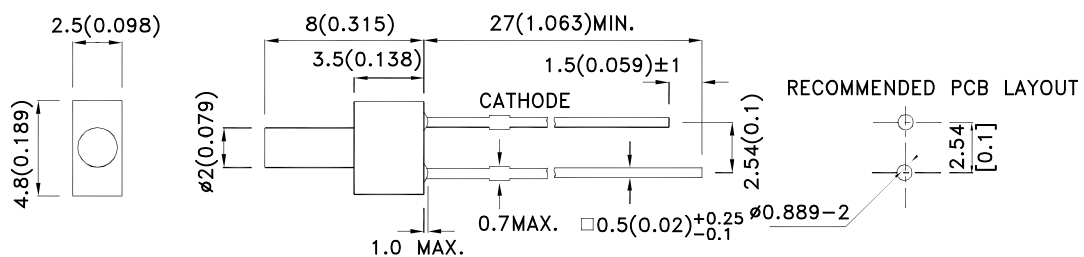

#### Notes:

1. All dimensions are in millimeters (inches).
2. Tolerance is  $\pm 0.25(0.01)$  unless otherwise noted.
3. Lead spacing is measured where the leads emerge from the package.
4. The specifications, characteristics and technical data described in the datasheet are subject to change without prior notice.



## Selection Guide

| Part No. | Dice                            | Lens Type    | Iv (mcd) [2]<br>@ 10mA |      | Viewing<br>Angle [1] |
|----------|---------------------------------|--------------|------------------------|------|----------------------|
|          |                                 |              | Min.                   | Typ. | 2θ1/2                |
| L-13ID   | High Efficiency Red (GaAsP/GaP) | Red Diffused | 8                      | 15   | 70°                  |
|          |                                 |              | *6                     | *12  |                      |

Notes:

1. θ1/2 is the angle from optical centerline where the luminous intensity is 1/2 of the optical peak value.
2. Luminous intensity/ luminous Flux: +/-15%.
- \*Luminous intensity value is traceable to the CIE127-2007 compliant national standards.

## Electrical / Optical Characteristics at TA=25°C

| Symbol             | Parameter                | Device              | Typ. | Max. | Units | Test Conditions           |
|--------------------|--------------------------|---------------------|------|------|-------|---------------------------|
| λ <sub>peak</sub>  | Peak Wavelength          | High Efficiency Red | 627  |      | nm    | I <sub>F</sub> =20mA      |
| λ <sub>D</sub> [1] | Dominant Wavelength      | High Efficiency Red | 617  |      | nm    | I <sub>F</sub> =20mA      |
| Δλ <sub>1/2</sub>  | Spectral Line Half-width | High Efficiency Red | 45   |      | nm    | I <sub>F</sub> =20mA      |
| C                  | Capacitance              | High Efficiency Red | 15   |      | pF    | V <sub>F</sub> =0V;f=1MHz |
| V <sub>F</sub> [2] | Forward Voltage          | High Efficiency Red | 2    | 2.5  | V     | I <sub>F</sub> =20mA      |
| I <sub>R</sub>     | Reverse Current          | High Efficiency Red |      | 10   | uA    | V <sub>R</sub> = 5V       |

Notes:

1. Wavelength: +/-1nm.
2. Forward Voltage: +/-0.1V.
3. Wavelength value is traceable to the CIE127-2007 compliant national standards.

## Absolute Maximum Ratings at TA=25°C

| Parameter                     | High Efficiency Red | Units |
|-------------------------------|---------------------|-------|
| Power dissipation             | 75                  | mW    |
| DC Forward Current            | 30                  | mA    |
| Peak Forward Current [1]      | 160                 | mA    |
| Reverse Voltage               | 5                   | V     |
| Operating/Storage Temperature | -40°C To +85°C      |       |
| Lead Solder Temperature [2]   | 260°C For 3 Seconds |       |
| Lead Solder Temperature [3]   | 260°C For 5 Seconds |       |

Notes:

1. 1/10 Duty Cycle, 0.1ms Pulse Width.
2. 2mm below package base.
3. 5mm below package base.

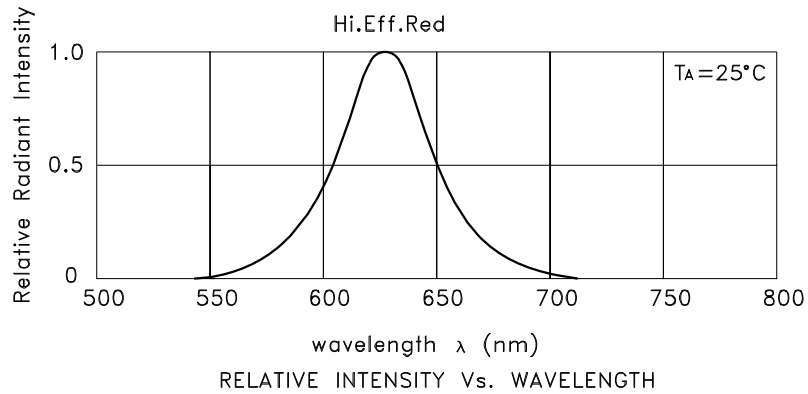

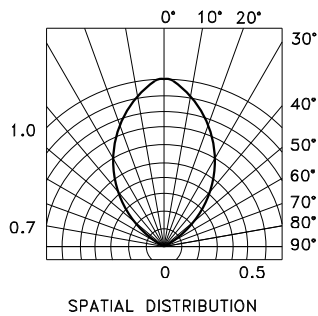
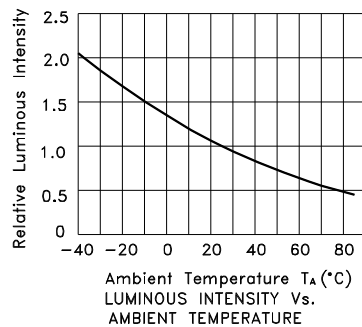
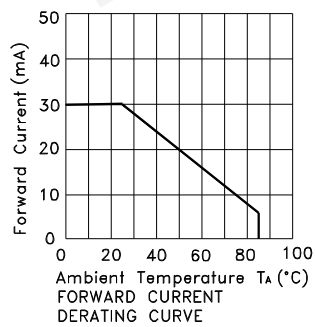
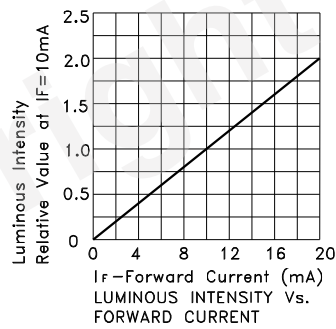
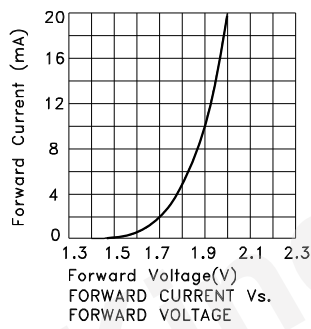

## High Efficiency Red L-131D

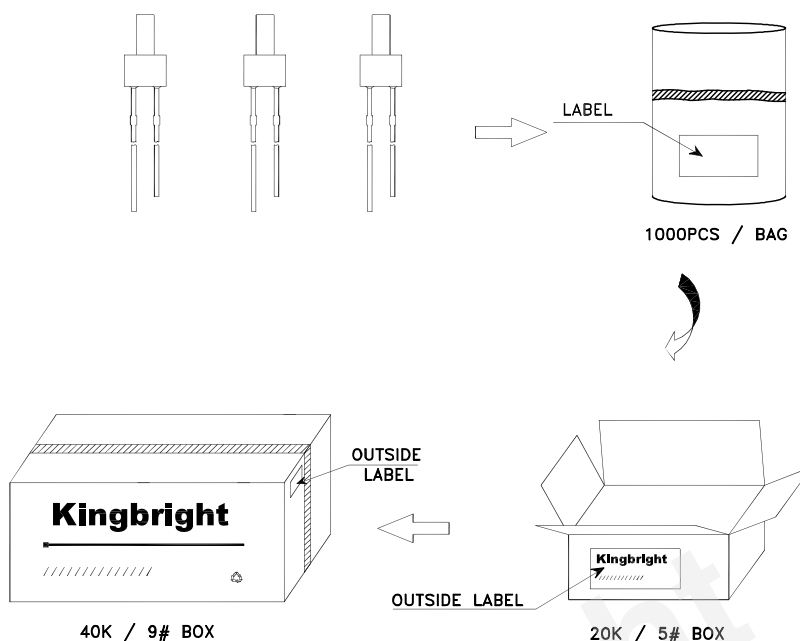

## PACKING & LABEL SPECIFICATIONS

L-13ID



|   |      |                             |
|---|------|-----------------------------|
| <b>Kingbright</b>   |      |                             |
| P/NO: L-13xxx   |      |                             |
| QTY: 1000 pcs   | Q.C. | Q C<br>XX-XX-XXXX<br>PASSED |
| S/N: XXXX   |      |                             |
| CODE: XXX   |      |                             |
| LOT NO:   |      |                             |
|  |      |                             |
| RoHS Compliant  |      |                             |

### Terms and conditions for the usage of this document

1. The information included in this document reflects representative usage scenarios and is intended for technical reference only.
2. The part number, type, and specifications mentioned in this document are subject to future change and improvement without notice. Before production usage customer should refer to the latest datasheet for the updated specifications.
3. When using the products referenced in this document, please make sure the product is being operated within the environmental and electrical limits specified in the datasheet. If customer usage exceeds the specified limits, Kingbright will not be responsible for any subsequent issues.
4. The information in this document applies to typical usage in consumer electronics applications. If customer's application has special reliability requirements or have life-threatening liabilities, such as automotive or medical usage, please consult with Kingbright representative for further assistance.
5. The contents and information of this document may not be reproduced or re-transmitted without permission by Kingbright.
6. All design applications should refer to Kingbright application notes available at [http://www.kingbright.com/application\\_notes](http://www.kingbright.com/application_notes)

## PRECAUTIONS

1. The lead pitch of the LED must match the pitch of the mounting holes on the PCB during component placement. Lead-forming may be required to insure the lead pitch matches the hole pitch. Refer to the figure below for proper lead forming procedures. (Fig. 1)

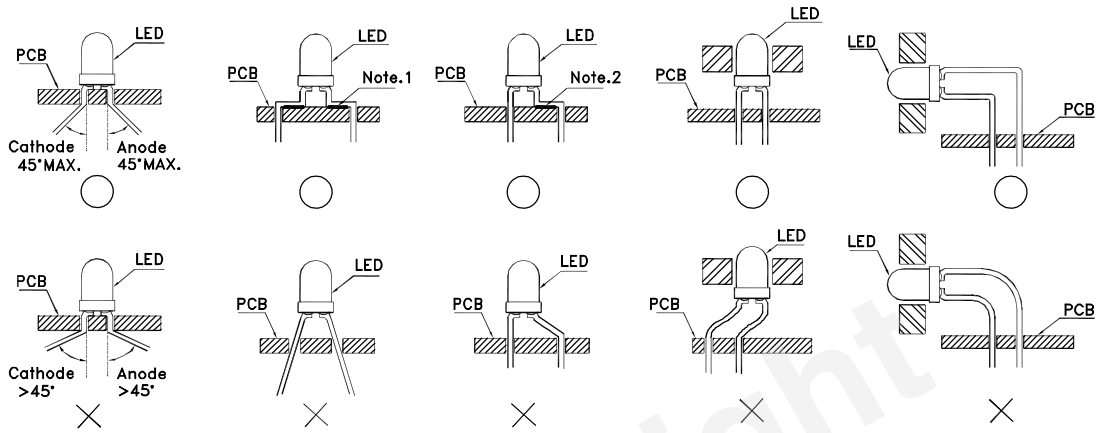

Fig.1

”○” Correct mounting method ”✗” Incorrect mounting method

2. When soldering wire to the LED, use individual heat-shrink tubing to insulate the exposed leads to prevent accidental contact short-circuit. (Fig.2)
3. Use stand-offs (Fig.3) or spacers (Fig.4) to securely position the LED above the PCB.

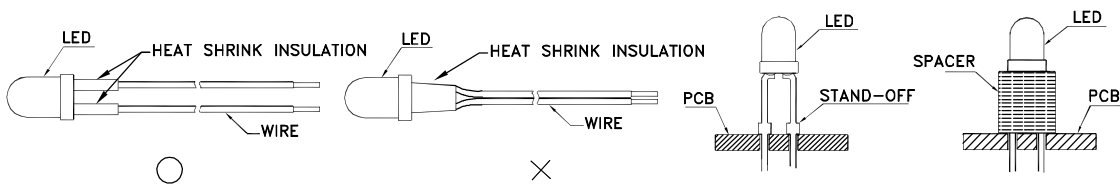

Fig. 2

Fig. 3

Fig. 4

4. Maintain a minimum of 3mm clearance between the base of the LED lens and the first lead bend. (Fig. 5 and 6)
5. During lead forming, use tools or jigs to hold the leads securely so that the bending force will not be transmitted to the LED lens and its internal structures. Do not perform lead forming once the component has been mounted onto the PCB. (Fig. 7)

6. Do not bend the leads more than twice. (Fig. 8)

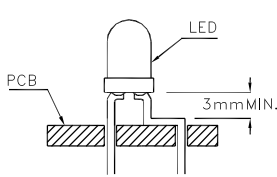

Fig. 5

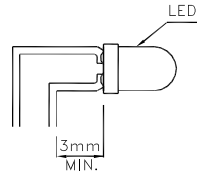

Fig. 6

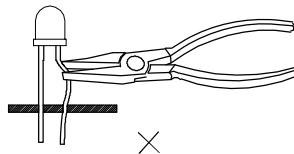

Fig. 7

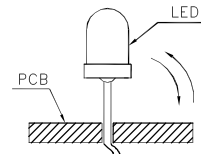
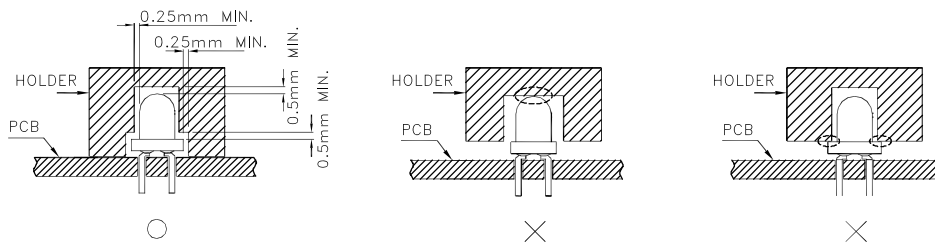

Fig. 8

7. During soldering, component covers and holders should leave clearance to avoid placing damaging stress on the LED during soldering.



8. The tip of the soldering iron should never touch the lens epoxy.

9. Through-hole LEDs are incompatible with reflow soldering.

10. If the LED will undergo multiple soldering passes or face other processes where the part may be subjected to intense heat, please check with Kingbright for compatibility.

11. Recommended Wave Soldering Profiles:

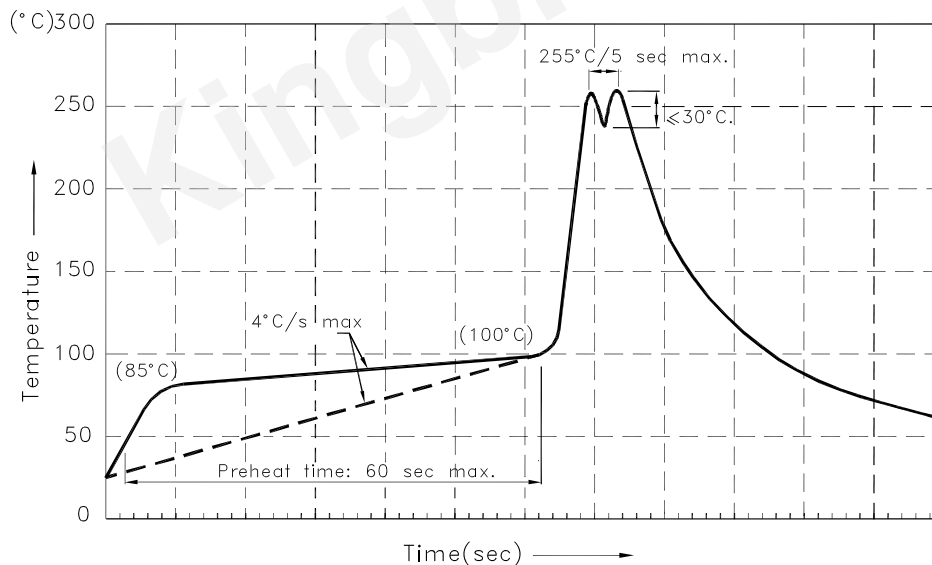

Notes:

1. Recommend pre-heat temperature of 105°C or less (as measured with a thermocouple attached to the LED pins) prior to immersion in the solder wave with a maximum solder bath temperature of 260°C
2. Peak wave soldering temperature between 245°C ~ 255°C for 3 sec (5 sec max).
3. Do not apply stress to the epoxy resin while the temperature is above 85°C.
4. Fixtures should not incur stress on the component when mounting and during soldering process.
5. SAC 305 solder alloy is recommended.
6. No more than one wave soldering pass.