

3.3 V LVDS 1-Bit, High-Speed Differential Driver

FIN1001

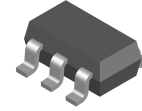

SOT-23, 5 Lead
 CASE 527AH

Description

This single driver is designed for high-speed interconnects utilizing Low Voltage Differential Signaling (LVDS) technology. The driver translates LVTTTL levels to LVDS levels with a typical differential output swing of 350 mV which provides low EMI at ultra low power dissipation even at high frequencies. This device is ideal for high-speed transfer of clock or data. The FIN1001 can be paired with its companion receiver, the FIN1002, or with any other LVDS receiver.

Features

- Greater than 600 Mbs Data Rate
- 3.3 V Power Supply Operation
- 0.5 ns Maximum Pulse Skew
- 1.5 ns Maximum Propagation Delay
- Low Power Dissipation
- Power-Off Protection
- Meets or Exceeds TIA/EIA-644 LVDS Standard
- Flow-through Pin-out Simplifies PCB Layout
- 5-Lead SOT23 Package Saves Space
- This is a Pb-Free and Halide Free Device

PIN DEFINITIONS

Pin No.	Name	Description
1	V _{CC}	Power Supply
2	GND	Ground
3	DOUT-	Inverting LVDS Driver Output
4	DOUT+	Non-inverting LVDS Driver Output
5	DIN	LVTTTL Data Input

FUNCTION TABLE

Inputs	Outputs	
D _{IN}	D _{OUT+}	D _{OUT-}
LOW	LOW	HIGH
HIGH	HIGH	LOW

MARKING DIAGRAMS

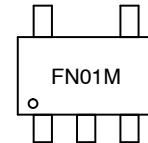

FN01 = Specific Device Code
 M = Assembly Operation
 Month

CONNECTION DIAGRAM

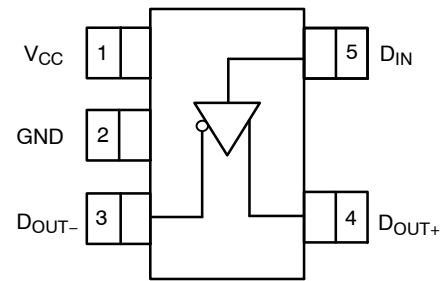

(Top View)

ORDERING INFORMATION

See detailed ordering and shipping information on page 6 of this data sheet.

FIN1001

ABSOLUTE MAXIMUM RATINGS

Symbol	Parameter	Min.	Max.	Unit	
V _{CC}	Supply Voltage	-0.5	4.6	V	
D _{IN}	DC Input Voltage	-0.5	6.0	V	
D _{OUT}	DC Output Voltage	-0.5	4.6	V	
I _{OSD}	Driver Short Circuit Current	Continuous			
I _O	Output Current	-	16	mA	
T _{STG}	Storage Temperature Range	-65	+150	°C	
T _J	Maximum Junction Temperature	-	+150	°C	
T _L	Lead Temperature, Soldering, 10 Seconds	-	+260	°C	
ESD	Electrostatic Discharge	Human Body Model	-	7500	V
		Machine Model	-	400	V

Stresses exceeding those listed in the Maximum Ratings table may damage the device. If any of these limits are exceeded, device functionality should not be assumed, damage may occur and reliability may be affected.

RECOMMENDED OPERATING CONDITIONS

Symbol	Parameter	Min.	Max.	Unit
V _{CC}	Supply Voltage	3.0	3.6	V
V _{IN}	Input Voltage	0	V _{CC}	V
T _A	Operating Temperature	-40	+125	°C

Functional operation above the stresses listed in the Recommended Operating Ranges is not implied. Extended exposure to stresses beyond the Recommended Operating Ranges limits may affect device reliability.

DC ELECTRICAL CHARACTERISTICS (Note 1)

All min and max values are guaranteed at T_A = -40°C to +125°C, unless otherwise specified.

All typical values are at T_A = 25°C and with V_{CC} = 3.3 V, unless otherwise specified.

Symbol	Parameter	Conditions	Min	Typ	Max	Unit	
V _{OD}	Output Differential Voltage	R _L = 100 Ω, See Figure 1	T _A = -40°C to 85°C	250	350	450	mV
			T _A = -40°C to 125°C	230	350	450	mV
ΔV _{OD}	VOD Magnitude Change from Differential Low-to-High	T _A = -40° to 125°C	-	-	25	mV	
V _{OS}	Offset Voltage		1.125	1.25	1.375	V	
ΔV _{OS}	Offset Magnitude Change from Differential Low-to-High		-	-	25	mV	
I _{OFF}	Power-Off Output Current	V _{CC} = 0 V, V _{OUT} = 0 V or 3.6 V	-	-	±20	μA	
I _{OS}	Short Circuit Output Current	V _{OUT} = 0 V	-	-5.5	-8	mA	
		V _{OD} = 0 V	-	±4	±8		
I _{I(OFF)}	Power-OFF Input Current	V _{CC} = 0 V, V _{IN} = 0 V or 3.6 V	-	-	±20	μA	
V _{IH}	Input HIGH Voltage		2.0	-	V _{CC}	V	
V _{IL}	Input LOW Voltage		GND	-	0.8	V	
I _{IN}	Input Current	V _{IN} = 0 V or V _{CC}	-	-	±20	μA	
I _{I(OFF)}	Power-Off Input Current	V _{CC} = 0 V, V _{IN} = 0 V or 3.6 V	-	-	±20	μA	
V _{IK}	Input Clamp Voltage	I _{IK} = -18 mA	-1.5	-0.8	-	V	
I _{CC}	Power Supply Current	No Load, V _{IN} = 0 V or V _{CC}	-	4.5	8	mA	
		R _L = 100 Ω, V _{IN} = 0 V or V _{CC}	-	6.5	10		
C _{IN}	Input Capacitance	V _{CC} = 3.3 V	-	3.2	-	pF	
C _{OUT}	Output Capacitance	V _{CC} = 0 V	-	3.3	-	pF	

Product parametric performance is indicated in the Electrical Characteristics for the listed test conditions, unless otherwise noted. Product performance may not be indicated by the Electrical Characteristics if operated under different conditions.

1. Not production tested across the full temperature range.

AC ELECTRICAL CHARACTERISTICS

All min and max values are guaranteed at $T_A = -40$ to $+85^\circ\text{C}$.

All typical values are at $T_A = 25^\circ\text{C}$ and with $V_{CC} = 3.3$ V, unless otherwise specified.

$R_L = 100 \Omega$, $C_L = 5$ pF. See Figure 2 and Figure 3.

Symbol	Parameter	Test Conditions	Min	Typ	Max	Unit
t_{PLHD}	Propagation Delay	LOW to HIGH	0.50	0.98	1.50	ns
t_{PHLD}	Propagation Delay	HIGH to LOW	0.50	0.93	1.50	ns
t_{TLHD}	Differential Output Rise Time	20% to 80%	0.4	0.5	1.0	ns
t_{THLD}	Output Fall Time	80% to 20%	0.4	0.5	1.0	ns
$t_{SK(p)}$	Pulse Skew	$ t_{PLH} - t_{PHL} $	-	0.05	0.5	ns
$t_{SK(PP)}$	Part-to-Part Skew (Note 2)		-	-	1.0	ns

2. $t_{SK(PP)}$ is the magnitude of the difference in propagation delay times between any specified terminals of two devices switching in the same direction (either LOW-to-HIGH or HIGH-to-LOW) when both devices operate with the same supply voltage, same temperature, and have identical test circuits

TEST DIAGRAMS

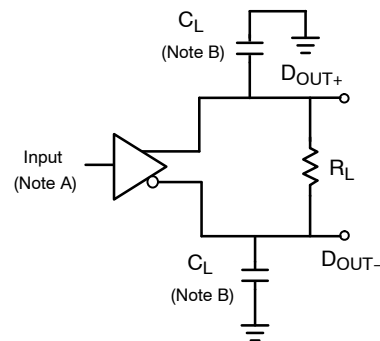
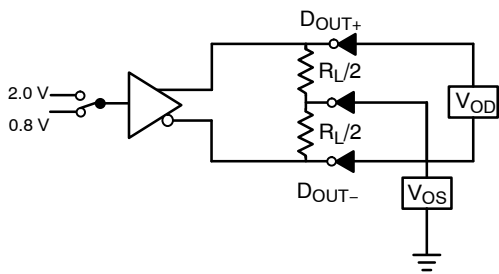

Note A: All input pulses have frequency = 10 Mhz, t_R or $t_F = 2$ ns

Note B: C_L includes all probe and fixture capacitances

Figure 1. Differential Driver DC Test Circuit

Figure 2. Differential Driver Propagation Delay and Transition Time Test Circuit

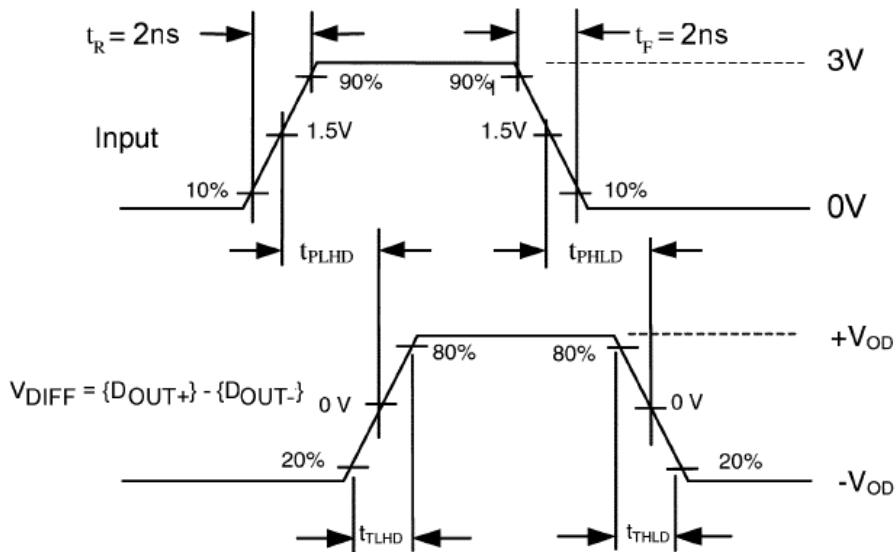

Figure 3. AC Waveforms

TYPICAL PERFORMANCE CHARACTERISTICS

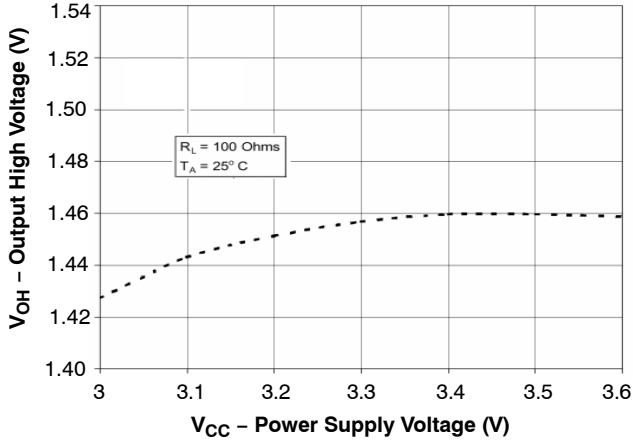

Figure 4. Output High Voltage vs. Power Supply Voltage

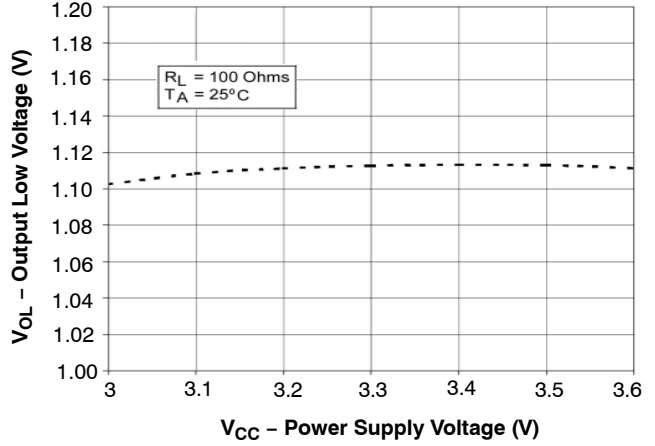

Figure 5. Output Low Voltage vs. Power Supply Voltage

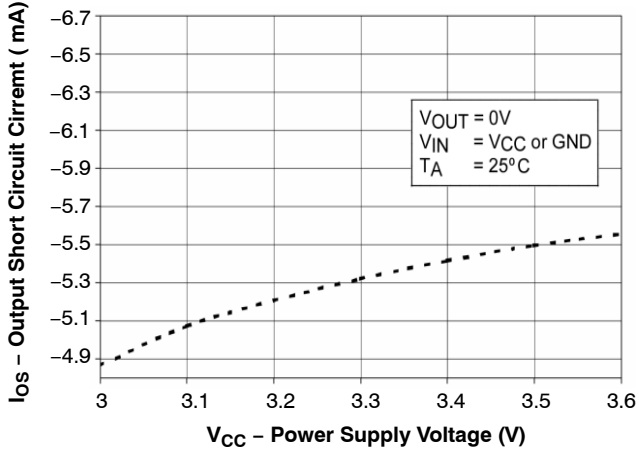

Figure 6. Output Short Circuit Current vs. Power Supply Voltage

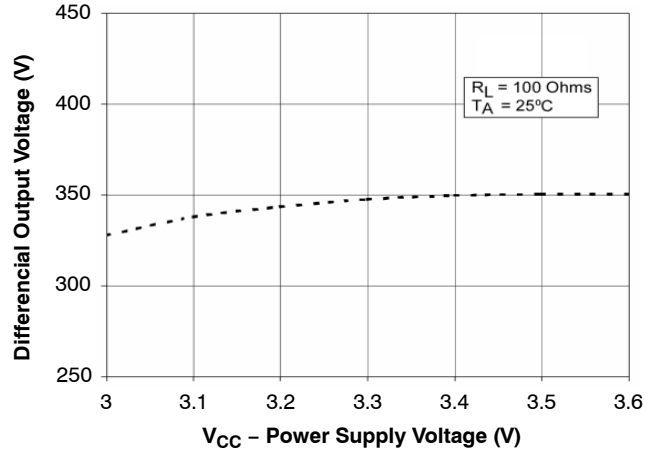

Figure 7. Differential Output Voltage vs. Power Supply Voltage

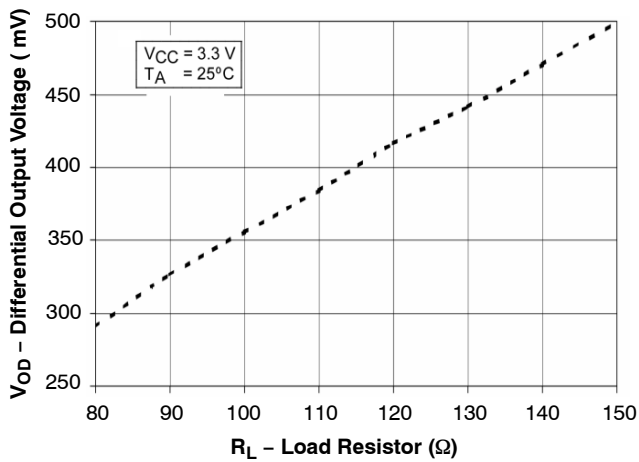

Figure 8. Differential Output Voltage vs. Load Resistor

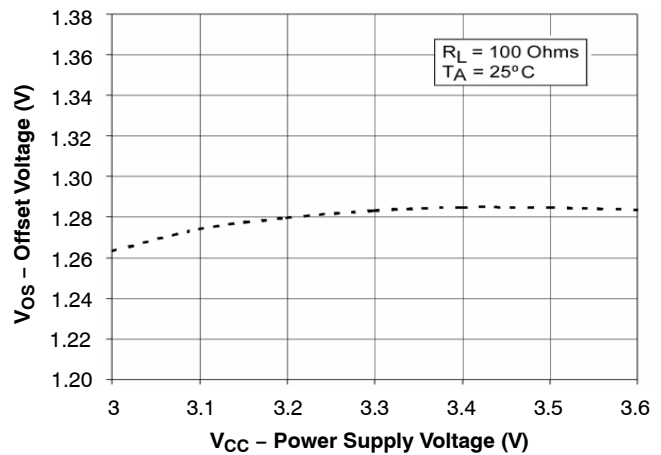

Figure 9. Offset Voltage vs. Power Supply Voltage

TYPICAL PERFORMANCE CHARACTERISTICS

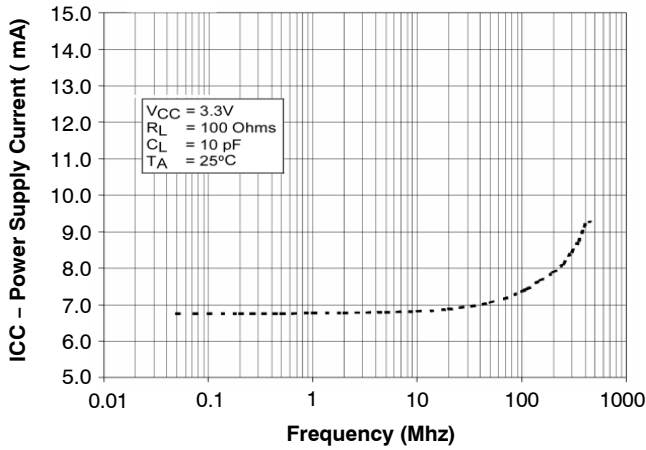

Figure 10. Power Supply Current vs. Frequency

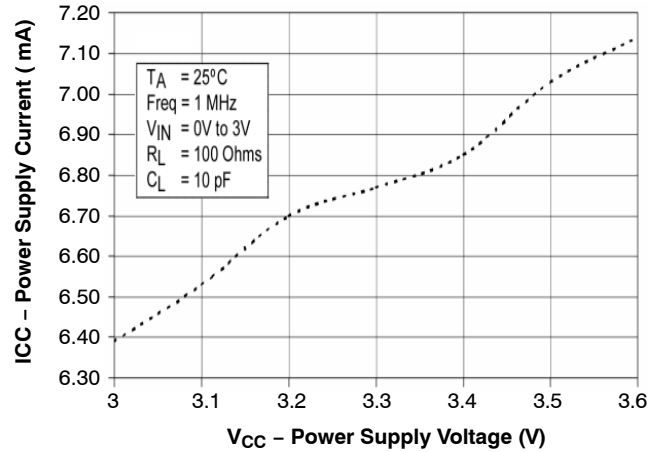

Figure 11. Power Supply Current vs. Power Supply Voltage

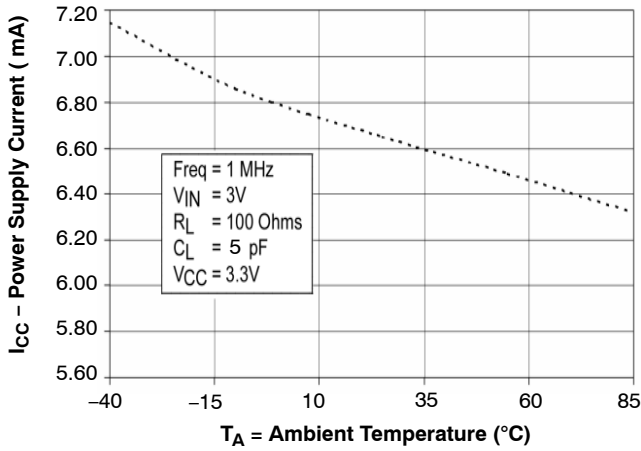

Figure 12. Power Supply Current vs. Ambient Temperature

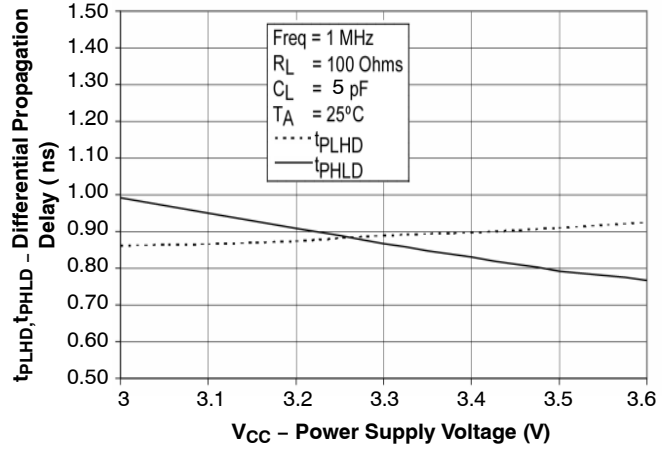

Figure 13. Differential Propagation Delay vs. Power Supply

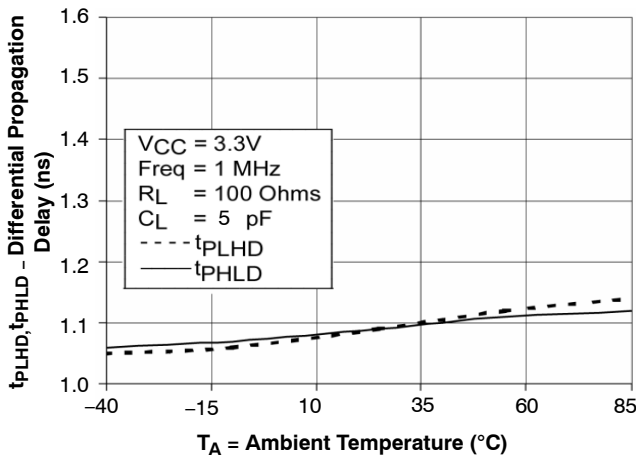

Figure 14. Differential Propagation Delay vs. Ambient Temperature

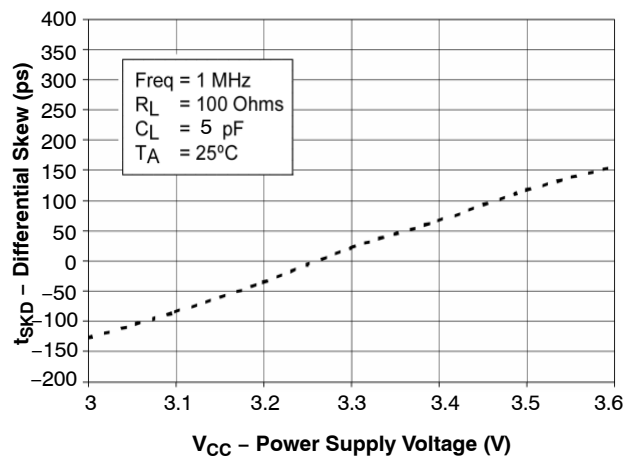

Figure 15. Differential Pulse Skew ($t_{PLH} - t_{PHL}$) vs. Power Supply Voltage

FIN1001

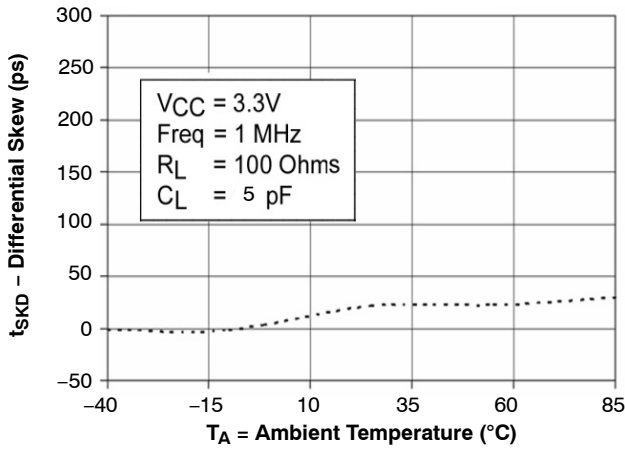

Figure 16. Differential Pulse Skew ($t_{PLH} - t_{PHL}$) vs. Ambient Temperature

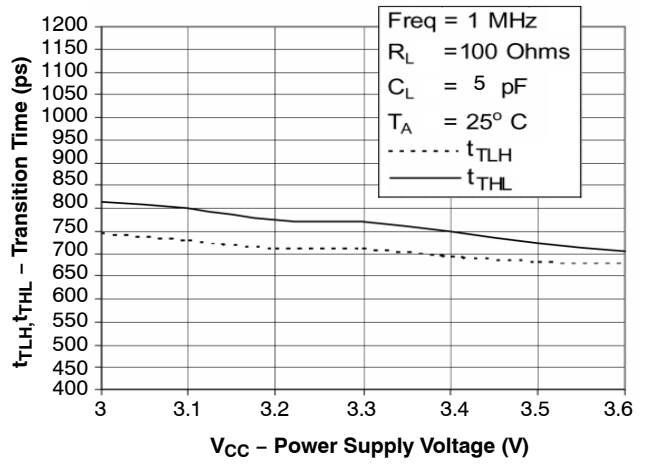

Figure 17. Transition Time vs. Power Supply Voltage

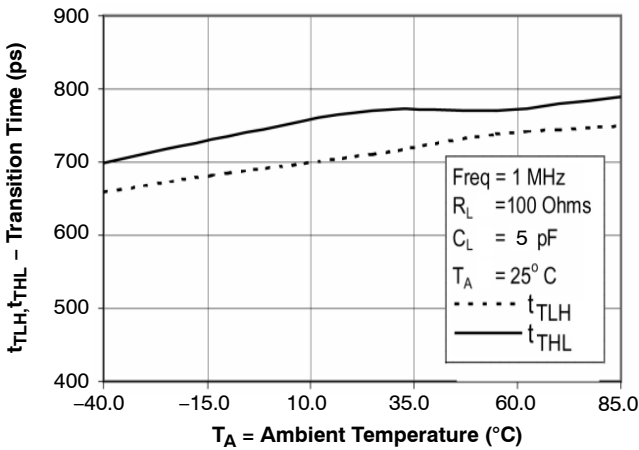

Figure 18. Transition Time vs. Ambient Temperature

ORDERING INFORMATION

Part Number	Operating Temperature Range	Package	Shipping [†]
FIN1001M5X	-40°C – +125°C	5-Lead SOT23, JEDEC MO-178, 1.6 mm (Pb-Free)	3000 / Tape & Reel

[†]For information on tape and reel specifications, including part orientation and tape sizes, please refer to our Tape and Reel Packaging Specifications Brochure, [BRD8011/D](#).

MECHANICAL CASE OUTLINE PACKAGE DIMENSIONS

ON Semiconductor®

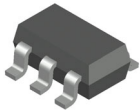

SOT-23, 5 Lead CASE 527AH ISSUE A

DATE 09 JUN 2021

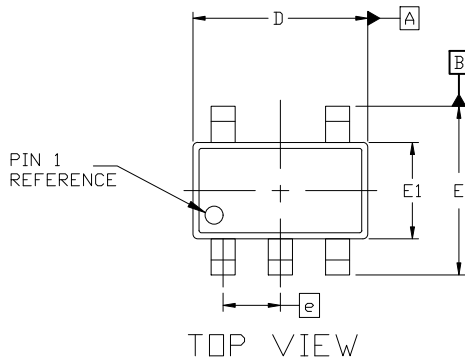

NOTES:

1. DIMENSIONING AND TOLERANCING PER ASME Y14.5M, 1989A
2. CONTROLLING DIMENSION: MILLIMETERS
3. MAXIMUM LEAD THICKNESS INCLUDES LEAD FINISH THICKNESS. MINIMUM LEAD THICKNESS IS THE MINIMUM THICKNESS OF THE BASE MATERIAL.
4. DIMENSIONS D AND E1 DO NOT INCLUDE MOLD FLASH, PROTRUSIONS, OR GATE BURRS. MOLD FLASH, PROTRUSIONS, OR GATE BURRS SHALL NOT EXCEED 0.25 PER SIDE. D AND E1 DIMENSIONS ARE DETERMINED AT DATUM D.
5. DIMENSION 'b' DOES NOT INCLUDE DAMBAR PROTRUSION. ALLOWABLE DAMBAR PROTRUSION SHALL BE 0.08mm TOTAL IN EXCESS OF THE 'b' DIMENSION AT MAXIMUM MATERIAL CONDITION. MINIMUM SPACE BETWEEN PROTRUSION AND AN ADJACENT LEAD SHALL NOT BE LESS THAN 0.07mm.

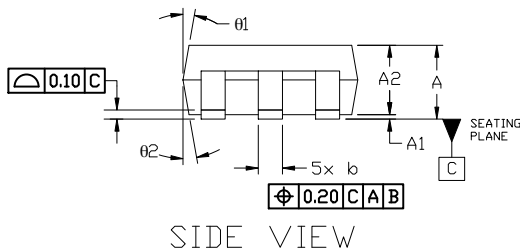

DIM	MILLIMETERS		
	MIN.	NOM.	MAX.
A	0.90	—	1.45
A1	0.00	—	0.15
A2	0.90	1.15	1.30
b	0.30	—	0.50
c	0.08	—	0.22
D	2.90 BSC		
E	2.80 BSC		
E1	1.60 BSC		
e	0.95 BSC		
L	0.30	0.45	0.60
L1	0.60 REF		
L2	0.25 REF		
theta	0°	4°	8°
theta1	0°	10°	15°
theta2	0°	10°	15°

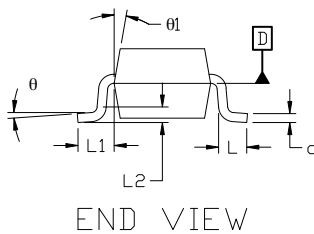

GENERIC MARKING DIAGRAM*

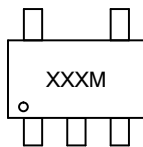

XXX = Specific Device Code
M = Date Code

*This information is generic. Please refer to device data sheet for actual part marking. Pb-Free indicator, "G" or microdot "•", may or may not be present. Some products may not follow the Generic Marking.

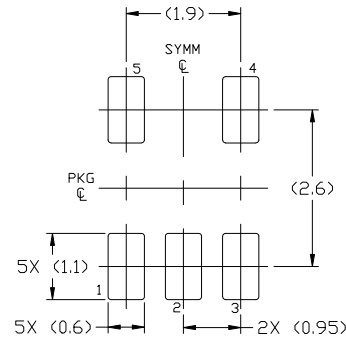

For additional information on our Pb-Free strategy and soldering details, please download the ON Semiconductor Soldering and Mounting Techniques Reference Manual, SOLDERRM/D.

DOCUMENT NUMBER:	98AON34320E	Electronic versions are uncontrolled except when accessed directly from the Document Repository. Printed versions are uncontrolled except when stamped "CONTROLLED COPY" in red.
DESCRIPTION:	SOT-23, 5 LEAD	PAGE 1 OF 1

ON Semiconductor and ON are trademarks of Semiconductor Components Industries, LLC dba ON Semiconductor or its subsidiaries in the United States and/or other countries. ON Semiconductor reserves the right to make changes without further notice to any products herein. ON Semiconductor makes no warranty, representation or guarantee regarding the suitability of its products for any particular purpose, nor does ON Semiconductor assume any liability arising out of the application or use of any product or circuit, and specifically disclaims any and all liability, including without limitation special, consequential or incidental damages. ON Semiconductor does not convey any license under its patent rights nor the rights of others.

onsemi, **Onsemi**, and other names, marks, and brands are registered and/or common law trademarks of Semiconductor Components Industries, LLC dba "**onsemi**" or its affiliates and/or subsidiaries in the United States and/or other countries. **onsemi** owns the rights to a number of patents, trademarks, copyrights, trade secrets, and other intellectual property. A listing of **onsemi**'s product/patent coverage may be accessed at www.onsemi.com/site/pdf/Patent-Marking.pdf. **onsemi** reserves the right to make changes at any time to any products or information herein, without notice. The information herein is provided "as-is" and **onsemi** makes no warranty, representation or guarantee regarding the accuracy of the information, product features, availability, functionality, or suitability of its products for any particular purpose, nor does **onsemi** assume any liability arising out of the application or use of any product or circuit, and specifically disclaims any and all liability, including without limitation special, consequential or incidental damages. Buyer is responsible for its products and applications using **onsemi** products, including compliance with all laws, regulations and safety requirements or standards, regardless of any support or applications information provided by **onsemi**. "Typical" parameters which may be provided in **onsemi** data sheets and/or specifications can and do vary in different applications and actual performance may vary over time. All operating parameters, including "Typicals" must be validated for each customer application by customer's technical experts. **onsemi** does not convey any license under any of its intellectual property rights nor the rights of others. **onsemi** products are not designed, intended, or authorized for use as a critical component in life support systems or any FDA Class 3 medical devices or medical devices with a same or similar classification in a foreign jurisdiction or any devices intended for implantation in the human body. Should Buyer purchase or use **onsemi** products for any such unintended or unauthorized application, Buyer shall indemnify and hold **onsemi** and its officers, employees, subsidiaries, affiliates, and distributors harmless against all claims, costs, damages, and expenses, and reasonable attorney fees arising out of, directly or indirectly, any claim of personal injury or death associated with such unintended or unauthorized use, even if such claim alleges that **onsemi** was negligent regarding the design or manufacture of the part. **onsemi** is an Equal Opportunity/Affirmative Action Employer. This literature is subject to all applicable copyright laws and is not for resale in any manner.

PUBLICATION ORDERING INFORMATION

LITERATURE FULFILLMENT:

Email Requests to: orderlit@onsemi.com

onsemi Website: www.onsemi.com

TECHNICAL SUPPORT

North American Technical Support:

Voice Mail: 1 800-282-9855 Toll Free USA/Canada

Phone: 011 421 33 790 2910

Europe, Middle East and Africa Technical Support:

Phone: 00421 33 790 2910

For additional information, please contact your local Sales Representative

Mouser Electronics

Authorized Distributor

Click to View Pricing, Inventory, Delivery & Lifecycle Information:

[onsemi:](#)

[FIN1001M5](#) [FIN1001M5X](#)