

APPLICATION NOTE

FSTN LCD DISPLAY MODULE

スリムデザインディスプレイモジュール
SLIM DESIGN DISPLAY MODULE

AH148AA/AB/AC/
BA/BB/BC

概要 GENERAL DESCRIPTION

スリムデザインディスプレイモジュール
『AH148AA/AB/AC/BA/BB/BC』は、FSTN-LCDを使用した20桁2段
を表示するモジュールです。

各文字は5×8ドットマトリクスで表示されております
このモジュールは、FSTN-LCD、ワンチップコントローラーと電源
(DC-DC/ACコンバータ)から構成されておりますので、ホストCPUと
容易に接続することができます。

Slim Design Display Module

『AH148AA/AB/AC/BA/BB/BC』 with VFD display, produces 20
digits on 2 rows.

Each character is displayed in 5×8 dot matrix.

This module is composed of FSTN-LCD, one chip controller, power
supply (DC-DC/AC converter), is easy to connect to host CPU.



安全にお使いいただくために Important Safety Notice

安全に御使用頂く為に必ず本書をお読み下さい。
また、本書はお読みになった後も大切に保管して下さい。
Please read this note carefully before using the product.

警告 Warning

- 感電およびショートによる破損の恐れがある為、製品の金属部分に直接人体が触れないようにして頂くとともに、製品の基板上の部分が他の金属部品と接触しない様にして下さい。

There is fear of breakage by an electric shock and electrical short circuit.

Please prevent from touching a human body directly at the metallic portion of a product.

Please keep a product from contacting metal parts.

- モジュールの電源回路には、コンデンサが接続されております。
電源を切った後、直ちに回路をショートするとIC等を破損する事があります。
(放電には30秒程度の時間を要します) また、感電の恐れがありますので、製品の金属部分に直接人体が触れないようにして下さい。

After turning off the power, Electronic components may be damaged if a circuit is short-circuited.

Do not touch the electronic components of the module with any metal objects.

- モジュールには保護素子が搭載されており、何らかの不具合が発生した場合、保護素子が働き、事故を未然に防ぎます。

The module is equipped with a circuit protection Reset table Fuse.

- 外部の電源を入れたまま（又はモジュールの電源を入れたまま）電源ケーブルを抜き差しすることは絶対に避けて下さい。感電の原因になります。

The power supply should be switched off before connecting or disconnecting the power or interface cables.

- 分解、修理、改造は絶対にしないで下さい。感電や火災の原因になります。

Under no circumstances should the module be modified or repaired.

Any unauthorized modifications or repairs will invalidate the product warranty.

- 廃棄する場合には、特別管理産業廃棄物として処理して下さい。

The module should be abolished as the factory waste.

目 次

CONTENTS

1. 特長 FEATURES	1
----------------	---

2. 一般仕様 GENERAL SPECIFICATIONS	
2-1. 外形寸法・重量 DIMENSION, WEIGHT	1
2-2. 製品種類 MODEL VARIATION	2
2-3. 表示部仕様 SPECIFICATION OF THE DISPLAY	2
2-4. 環境条件 ENVIRONMENT CONDITIONS	2
2-5. 絶対最大定格 ABSOLUTE MAXIMUM ELECTRICAL	3
2-6. 推奨動作条件 RECOMMEND OPERATING CONDITIONS	3
2-7. 標準動作条件における電氣的、光学的特性 ELECTRICAL CHARACTERISTICS	4

3. 基本機能 FUNCTION SUMMARY	
3-1. RS232C インターフェース RS232C INTERFACE	5
3-1-1. 受信の条件 DATA RECEPTION	5
3-1-2. 異常時の処理 COMMUNICATION ERROR	5
3-2. USB インターフェース USB INTERFACE	5
3-2-1. USB-HID	6
3-2-2. USB ディスクリプタ仕様 USB DESCRIPTOR SPECIFICATION	7
3-3. Bluetooth(iAP)インターフェース BLUETOOTH(iAP) INTERFACE	11
3-3-1. インターフェース INTERFACE	11
3-3-2. 電波法認証 RADIO AUTHENTICATION METHOD	11
3-3-3. Bluetooth 仕様 BLUETOOTH SPECIFICATION	12
3-3-4. Bluetooth 動作状態説明 BLUETOOTH OPERATING STATE DESCRIPTION	13
3-3-4-1. BT_STATUS_LED	13
3-3-4-2. BT_RENEW_SW	14
3-3-4-3. BT_CONNECT_SW	14
3-3-5. iAP Accessory 設定 iAP ACCESSORY SETTINGS	15
3-3-6. セキュリティ仕様 SECURITY	15

3-3-7. ペアリング仕様 PAIRING SPECIFICATION.....	15
4. コマンド COMMAND	
4-1. コマンド詳細 FUNCTION OF COMMANDS.....	16
5. コネクタ接続 CONECTER CONNECTION	
5-1. RS232C TYPE (AH148AA/BA)	32
5-2. USB TYPE (AH148AB/BB)	33
5-3. BLUETOOTH (iAP) TYPE (AH148AC/BC)	34
FIGURE-1 外形図 Outer Dimensions.....	35
FIGURE-2 外形図 Outer Dimensions.....	36
FIGURE-3 ブロック図 RS232C Type (AH148AA/BA) Block Diagram	37
FIGURE-4 ブロック図 USB Type (AH148AB/BB) Block Diagram	38
FIGURE-5 ブロック図 BLUETOOTH(iAP) type (AH148AC/BC) Block Diagram	39
FIGURE-6 Font Table.....	40
6. 保証 WARRANTY.....	45
7. 規制物資等の該非判定及び、輸出する際の注意事項 CAUTIONS FOR DETERMINING AND EXPORTING REGULATED GOODS OR SERVICES.....	45
8. 環境対応 ENVIRONMENTALLY CONSCIENTIOUS.....	45
9. 使用上の注意事項	46

1. 特徴 FEATURES

- 1-1. 本製品は 5x8 ドット、20 桁 2 段の FSTN-LCD で構成されているケース付モジュールです。
FSTN-LCD module with case consists of a 20 character by 2 line 5×8 dot matrix display.
- 1-2. 本製品のホスト間との通信プロトコルは RS232C、USB2.0 Full Speed Function、Bluetooth 3.0 に準拠しております。
This module supports RS232C, USB2.0 Full Speed Function, Bluetooth 3.0 interface.
- 1-3. 本製品で表示画面を維持する場合は、定期的に同じ表示画面を送信することを推奨します。
If you want to keep the display in this module, it is recommended that you regularly send the same display.
- 1-4. 電源は USB バスパワー(5V/500mA)で動作可能です。
Power supply is capable of operating on USB bus power (5V / 500mA).
- 1-5. 本製品には下表の文字フォントを搭載しております。
This module is mounted the character font of below table.

Table-1

1 バイト文字 1 byte character			
番号 No.	フォント Font	番号 No.	フォント Font
1	USA	13	Latin America
2	France	14	Korea
3	Germany	15	PC437 (USA: Standard Europe)
4	Great Britain	16	Katakana
5	Denmark 1	17	PC850 (Multilingual)
6	Sweden	18	PC860 (Portuguese)
7	Italy	19	PC863(Canadian-French)
8	Spain 1	20	PC865 (Norwegian)
9	Japan	21	WPC1252
10	Norway	22	PC866 [Cyrillic #2]
11	Denmark 2	23	PC852 [Latin 2]
12	Spain 2	24	PC858

2. 一般仕様 GENERAL SPECIFICATION

2-1. 外形寸法・重量 DIMENSIONS, WEIGHT (Refer to FIGURE-1)

Table-2

項目 Parameter	仕様 Specification	単位 Unit
外形寸法 Outer Dimensions (NOTE1)	(W)141±0.5 (H)79±1 (T)60±0.5	mm
重量 Weight	Approx.200	g

NOTE1) 外形寸法 (T) と重量は、配線クランプと電源コードを含みません。

Outer Dimensions (T) does not include the wiring clamp and power supply cord.

2-2. 製品種類 MODEL VARIATION

Table-3

製品番号 TYPE No.	ケース色 Case Color	インターフェース I/F	付属ケーブル Supplied cable	ケーブル色 Cable Color
AH148AA	White	RS232C	Not support	—
AH148BA	Black	RS232C	Not support	—
AH148AB	White	USB	USB type A to Mini B cable	White
AH148BB	Black	USB	USB type A to Mini B cable	Black
AH148AC	White	Bluetooth(iAP)	USB type A to Mini B cable	White
AH148BC	Black	Bluetooth(iAP)	USB type A to Mini B cable	Black

2-3. 表示部仕様 SPECIFICATION OF THE DISPLAY

Table-4

項目 Parameter	仕様 Specification	単位 Unit
画面仕様 Display Specification	FSTN / NEGATIVE / TRANSMISSIVE	—
ビューエリア View Area	105.75 (W)×22.5(H)	mm
アクティブエリア Active Area	97.00 (W)×18.92(H)	mm
画素数 Number of Pixels	20 digits (5×8 Dots)×2 rows	Dot
ドットサイズ Dot size	0.7(W)×1.02(H)	mm
ドットピッチ Dot pitch	0.8(W)×1.12(H)	mm
バックライト Backlight	LED	—
バックライト色 Backlight Color	White	—
コントラスト Contrast(Note 2)	4.5	—
視野角 View Angle (Note 3) Cr ≥ 3	Bottom=40,Top=40, Left=35,Right=35	deg

Note2) $\theta_x = \theta_y = 0^\circ$ Ta=25°C.

Note3) Bottom は付図-1 の⑤側になります。 Bottom will be ⑤ side of Figure 1.

2-4. 環境条件 ENVIRONMENT CONDITIONS

Table-5

項目 Parameter	記号 Symbol	最小 Min.	最大 Max.	単位 Unit
動作温度 Operation Temperature	Topr	0	+40	°C
保存温度 Storage Temperature	Tstg	-20	+70	°C
動作湿度 Operation Humidity	Hopr	20	85	%
保存湿度 Storage Humidity(Note4)	Hstg	20	90	%
振動 Vibration (10~55Hz)	—	—	4	G
衝撃 Shock	—	—	40	G

Note4) 結露無きこと。 Avoid operations and or storage in moist environmental conditions.

2-5. 絶対最大定格 ABSOLUTE MAXIMUM ELECTRICAL RATINGS

Table-6

項目 Parameter	記号 Symbol	最小 Min.	最大 Max.	単位 Unit
電源電圧 Supply Voltage	Vcc	-0.3	+6.0	Vdc
入力信号電圧 (RS232C) Input Signal Voltage (RS232C)	V _{IS}	-15	+15	Vdc
入力信号電圧 (USB) Input Signal Voltage (USB)	V _{IS}	-0.3	+3.6	Vdc

2-6. 推奨動作条件 RECOMMEND OPERATING CONDITIONS

Table-7

項目 Parameter	記号 Symbol	最小 Min.	標準 Typ.	最大 Max.	単位 Unit
電源電圧 Supply Voltage	Vcc	4.75	5.0	5.25	Vdc

2-7. 標準動作条件における電氣的、光学的特性 ELECTRICAL CHARACTERISTICS

Table-8

項目 Parameter	記号 Symbol	条件 Condition	最小 Min.	標準 Typ.	最大 Max.	単位 Unit
消費電流 Supply Current (Note 5)	I _{cc}	V _{cc} =5.0V All on	—	50	80	mA
消費電力 Power Consumption	—		—	0.25	0.4	W
輝度 Luminance (Note 6)	L		90	130	—	cd/m ²
色度(白) White Chromaticity	X Y	$\theta = 0^\circ$ $\theta = 0^\circ$	0.26 0.26	— —	0.36 0.36	— —
バックライト寿命 LED Life Time (Note7)	—	T _a =25°C	30,000	—	—	hrs
応答時間 Response Time	Tr Tf	T _a =25°C	— —	150 110	— —	ms
入力 H レベル電圧 (RS232C) H-level input Voltage (RS232C)	V _{IH}		V _{cc} =5.0V	2.0	—	15
入力 L レベル電圧 (RS232C) L-level input Voltage (RS232C)	V _{IL}	V _{cc} =5.0V	-15	—	0.8	
出力電圧 (RS232C) Output Voltage (RS232C)	V _O	All driver outputs loaded with 3k Ω to GND	± 5.0	± 5.4	—	
入力 H レベル電圧 (USB) H-level input Voltage (USB)	V _{IH}	V _{cc} =5.0V	2.0	—	—	
入力 L レベル電圧 (USB) L-level input Voltage (USB)	V _{IL}	V _{cc} =5.0V	—	—	0.8	
差動入力感度 (USB) Differential Input Sensitivity (USB)	V _{DI}	V _{cc} =5.0V	0.2	—	—	

Note5) RS232C 仕様の場合、電源投入時に最大電流の約 5 倍の突入電流が発生します。

USB/Bluetooth 仕様の場合、電源電圧部に 10 μ F 以下の容量があり、電源投入時に突入電流が発生します。

Case of the RS232C type, the surge current can be approx. 5 times the supply current (Max.) at power on.

Case of the USB/Bluetooth type, the capacity of 10 or less is in a power supply circuit of module. Inrush current occurs in power-on.

Note6) 輝度レベル 100%の輝度値を示す。フィルタなしの値とする。フィルタの透過率は 93%となります。

The luminance level is set at 100% luminance value. It will be the value without the filter. Transmittance of the filter is 93%.

Note7) 期待寿命は標準輝度の 50%に達する時間となります。

The expected LED life time is defined as the module brightness decrease to 50% original brightness at T_a=25°C.

3. 基本機能 FUNCTION SUMMARY

3-1. RS232C インターフェース RS232C INTERFACE

Table-9

項目 Parameter	仕様 Specification
Signal level	RS-232C 準拠 RS-232C conformity
Baud Rate	38,400 bps
Parity bit	NON
Data bit length	8 bit(LSB first)
Format	Start(1bit)+Data(8bit)+Stop(1bit)

3-1-1. 受信の条件 DATA RECEPTION

本モジュールには 256byte の受信バッファを持っています。

The module has 256 bytes buffers for data reception.

3-1-2. 異常時の処理 COMMUNICATION ERROR

- a) モジュールから送信されたデータが、伝送上の理由でホストに受信されなかった場合、そのデータについては、モジュールは伝送済みのデータとして扱います。

When transferred data cannot be received properly at host system by the reason of the transmission failure, the module makes it the transmitted data.

- b) ホストからコマンド受信時にオーバーラン、フレーミングエラーが発生した場合、そのコマンドを無視します。

In case of the command reception, when the overrun or the framing error occurs, the command is ignored.

- c) ホストからデータ受信時にオーバーラン、フレーミングエラーが発生した場合は、そのデータを無視します。

In case of the display data reception, when the overrun or the framing error occurs, the display data is ignored.

- d) ホストからコマンド受信時にパリティエラーが発生した場合は、そのコマンドを無視します。

In case of the command reception, when the parity error occurs, the command is ignored.

- e) ホストからデータ受信時にパリティエラーが発生した場合は、そのデータを無視します。

In case of the display data reception, when the parity error occurs, the display data is ignored.

- f) ホストからイリガルコマンドを受信した場合は、そのコマンドを無視します。

When an illegal command is received, the command is ignored.

3-2-2. USB ディスクリプタ仕様 USB DESCRIPTOR SPECIFICATION.

Standard Device Descriptor

Table-10

Offset	Field	Description	Size[byte]	Value	Comment
0	bLength	Size of descriptor in bytes	1	12H	
1	bDescriptorType	DEVICE Descriptor Type	1	01H	
2	bcdUSB	USB Release Number in BCD	2	0200H	Rev.2.0
4	bDeviceClass	Class code	1	00H	
5	bDeviceSubClass	Subclass code	1	00H	
6	bDeviceProtocol	Protocol code	1	00H	
7	bMaxPacketSize	Maximum packet size for endpoint zero	1	40H	64 bytes
8	idVendor	Vendor ID	2	1008H	FUTABA
10	idProduct	Product ID	2	1029H	LC009A
12	bcdDevice	Device release number in BCD	2	0200H	Rev.2.00
14	iManufacturer	Index of string descriptor describing manufacturer	1	01H	
15	iProduct	Index of string descriptor describing product	1	02H	
16	iSerialNumber	Index of string descriptor describing the device's serial number	1	00H	
17	bNumConfigurations	Number of possible configurations	1	01H	

Standard Configuration Descriptor

Table-11

Offset	Field	Description	Size[byte]	Value	Comment
0	bLength	Size of this descriptor in bytes	1	09H	
1	bDescriptorType	CONFIGURATION Descriptor Type	1	02H	
2, 3	wTotalLength	Total length of data returned for this configuration	2	0029H	41 bytes
4	bNumInterfaces	Number of interfaces supported by this configuration	1	01H	
5	bConfigurationValue	Value to use as an argument	1	01H	
6	iConfiguration	Index of string descriptor describing this configuration	1	00H	
7	bmAttributes	Configuration characteristics	1	80H	Bus-powered
8	bMaxPower	Maximum power consumption	1	FAH	500mA

Interface Descriptor

Table-12

Offset	Field	Description	Size[Byte]	Value	Comment
0	bLength	Size of this descriptor in bytes	1	09H	
1	bDescriptorType	INTERFACE Descriptor Type	1	04H	
2	bInterfaceNumber	Number of this interface	1	00H	
3	bAlternateSetting	Value used to select this alternate setting	1	00H	
4	bNumEndpoints	Number of endpoints used by this interface	1	02H	
5	bInterfaceClass	Class code	1	03H	HID
6	bInterfaceSubClass	Subclass code	1	00H	
7	bInterfaceProtocol	Protocol code	1	00H	
8	iInterface	Index of string descriptor describing this interface	1	00H	

HID Descriptor

Table-13

Offset	Field	Description	Size[Byte]	Value	Comment
0	bLength	Size of HID descriptor	1	09H	
1	bDescriptorType	HID descriptor type	1	21H	HID Class descriptor
2	bcdHID	HID class specification	2	0111H	HID Revision 1.11
4	bCountry	Country code of the localized hardware	1	00H	Not defined
5	bNumDescriptors	Number of class descriptors	1	01H	1 report descriptor
6	bReportType	Type of class descriptor	1	22H	REPORT descriptor
7	wReportLength	Descriptor length	2	002FH	47 bytes

Endpoint Descriptor

Table-14

Offset	Description	Size[Byte]	Value	Comment
0	Size of this descriptor in bytes	1	07H	
1	ENDPOINT Descriptor Type	1	05H	
2	The address of the endpoint on the USB device described by this descriptor	1	87H	EP7, IN
3	The endpoint's attributes	1	03H	Interrupt Transfer
4	Maximum packet size this endpoint	2	0040H	64 bytes
6	Interval for polling endpoint for data transfers	1	04H	4[ms]

Endpoint Descriptor

Table-15

Offset	Description	Size[Byte]	Value	Comment
0	Size of this descriptor in bytes	1	07H	
1	ENDPOINT Descriptor Type	1	05H	
2	The address of the endpoint on the USB device described by this descriptor	1	06H	EP6, OUT
3	The endpoint's attributes	1	03H	Interrupt Transfer
4	Maximum packet size this endpoint	2	0040H	64 bytes
6	Interval for polling endpoint for data transfers	1	04H	4[ms]

HID Report Descriptor

Table-16

Part	Value (HEX)
Usage Page(Vendor-defined),	06 FF FF
Usage (VFD_CONTROL),	09 00
Collection (Application),	A1 01
Usage (DATA_INPUT),	09 02
Logical Minimum (0),	15 00
Logical Maximum (255),	26 FF 00
Report Size (8),	75 08
Report Count (64),	95 40
Input (Data,Variable,Absolute),	81 02
Usage (DATA_OUTPUT),	09 03
Logical Minimum (0),	15 00
Logical Maximum (255),	26 FF 00
Report Size (8),	75 08
Report Count (64),	95 40
Output (Data,Variable,Absolute),	91 02
Usage (FEATURE),	09 04
Logical Minimum (0),	15 00
Logical Maximum (255),	26 FF 00
Report Size (8),	75 08
Report Count (64),	95 40
Feature(Data,Variable,Absolute),	B1 02
End Collection	C0

String Descriptor

Table-17

No	Part	Description	Value
No.0	bLength	Length	0x04
	bDescriptorType	type=STRING	0x03
	bSting	LangID (English US)	0x0409
No.1	blength	Length	0x0E
	bDescriptorType	Type=STRING	0x03
	bSting	Manufacturer	FUTABA
No.2	bLength	Length	0x0E
	bDescriptorType	Type=STRING	0x03
	bSting	Product	LC009A

3-3. Bluetooth(iAP)インターフェース BLUETOOTH(iAP) INTERFACE

3-3-1. インターフェース INTERFACE

本モジュールのホスト間との通信プロトコルは Bluetooth 3.0 に準拠しております。

本製品の Bluetooth(iAP)対応機種は iPad Air, iPad Air2 となります。

本製品は、全ての Bluetooth 対応機器との接続を保証するものではありません。

This module supports Bluetooth 3.0 interface.

Bluetooth (iAP) support model of this module becomes iPad Air, iPad Air2.

Not guaranteed to connect to all Bluetooth devices.

3-3-2. 電波法認証 RADIO AUTHENTICATION METHOD

本製品は日本(工事設計認証)、米国(FCC)、カナダ(IC)の各種認証を取得済み、および欧州(CE)

規格の適合確認済みです。以下に各国の電波法で仕様書への必要事項について記載します。

This product is Japan (certificate of construction type), US (FCC), Canada (IC) of the various authentication already acquired, and Europe (CE) standards of suitability confirmed. The following summarizes the described items required in the specifications in the Radio Law of each country.

Table-18

項目 Parameter	必要事項 Matters
日本(工事設計認証) Japan (certificate of construction type)	本製品には電波法に基づく工事設計認証を受けた特定無線設備を用いています。
米国(FCC) US (FCC)	<p>This device complies with part 15 of the FCC Rules. Operation is subject to the following two conditions: (1) This device may not cause harmful interference, and (2) this device must accept any interference received, including interference that may cause undesired operation.</p> <p>FCC CAUTION Change or modifications not expressly approved by the party responsible for compliance could void the user's authority to operate the equipment.</p> <p>This transmitter must not be co-located or operated in conjunction with any other antenna or transmitter.</p> <p>Caution Exposure to radio frequency radiation To comply with FCC RF exposure compliance requirements, a separation distance of at least 20 cm must be maintained between the antenna of this device and all persons. This device must not be co-located or operating in conjunction with any other antenna or transmitter.</p>

<p>カナダ (IC) Canada (IC)</p>	<p>This device complies with Industry Canada licence-exempt RSS standard(s). Operation is subject to the following two conditions: (1) this device may not cause interference, and (2) this device must accept any interference, including interference that may cause undesired operation of the device.</p> <p>Le présent appareil est conforme aux CNR d'Industrie Canada applicables aux appareils radio exempts de licence. L'exploitation est autorisée aux deux conditions suivantes : (1) l'appareil ne doit pas produire de brouillage, et (2) l'utilisateur de l'appareil doit accepter tout brouillage radioélectrique subi, même si le brouillage est susceptible d'en compromettre le fonctionnement.</p> <p>To reduce potential radio interference to other users, the antenna type and its gain should be so chosen that the equivalent isotropically radiated power (EIRP) is not more than that required for successful communication.</p> <p>Pour réduire le potentiel d'interférence radioélectrique pour d'autres utilisateurs, le type d'antenne et son gain doivent être choisis pour que la puissance isotrope rayonnée équivalente (PIRE) soit limitée à celle juste requise pour obtenir une bonne communication.</p> <p>To comply with IC RF exposure compliance requirements, this device must not be co-located or operating in conjunction with any other antenna or transmitter.</p> <p>Pour se conformer aux exigences de conformité de la IC, cet appareil ne doit pas être co-localisées ou opérant en conjonction avec une autre antenne ou transmetteur</p>
<p>欧州 (CE) Europe (CE)</p>	<p>None</p>

3-3-3. Bluetooth 仕様 BLUETOOTH SPECIFICATION

Table-19

項目 Parameter	仕様 Specification
準拠仕様 Conformity specification	Bluetooth 3.0
パワークラス Power Class	CLASS 2
対応 Profile (AH148AC/BC) Supported Profile (AH148AC/BC)	iAP(iPod Accessory Protocol) <ul style="list-style-type: none"> • iAP1 • iAP2

3-3-4. Bluetooth 動作状態説明 BLUETOOTH OPERATING STATE DESCRIPTION

3-3-4-1. BT_STATUS_LED

LED の点滅で Bluetooth の動作状態を通知します。

Notify the Bluetooth operating state in flashing LED.

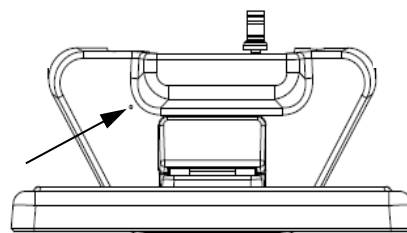

■ Inquiry (通信相手探索)

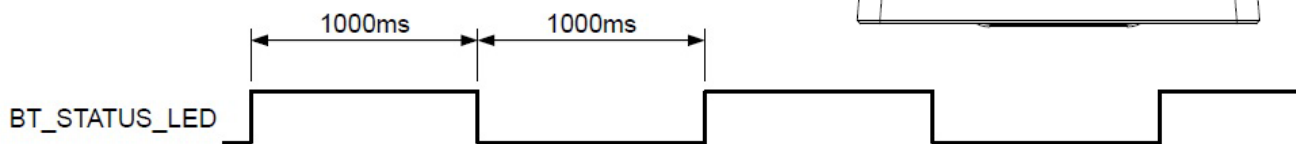

■ Discoverable (通信相手発見待ち)



■ Connectable (通信接続待ち)



■ Pairing (ペアリング)

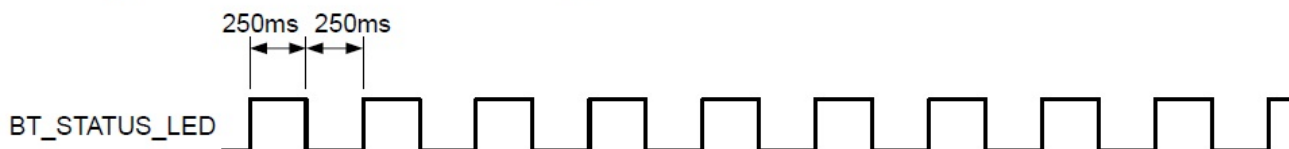

■ Connecting (通信接続判定)

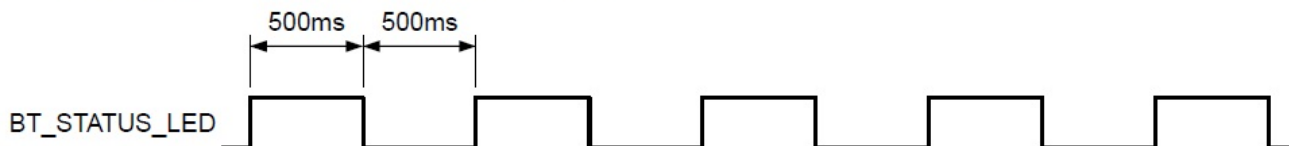

■ iAP(iAP1/ iAP2) Connected (iAP 接続完了)



■ **Disconnecting** (通信切断中)

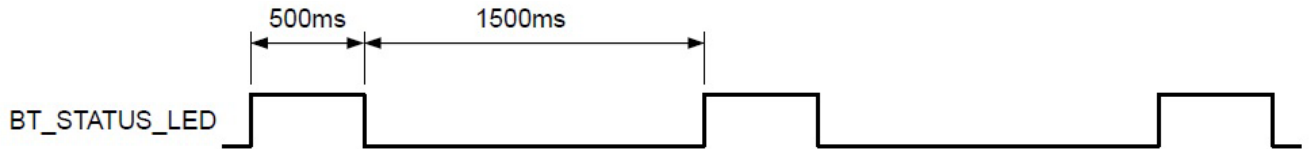

3-3-4-2. BT_RENEW_SW

RENEW スイッチを押す時間によって下記のように動作します。

スイッチ短押し: Bluetooth 接続/切断

スイッチ長押し: ペ어링情報データベースをクリア

It will work as follows by the time press RENEW switch.

Switch short press: Bluetooth connection / disconnection.

Switch long press: Clear the pairing information database.

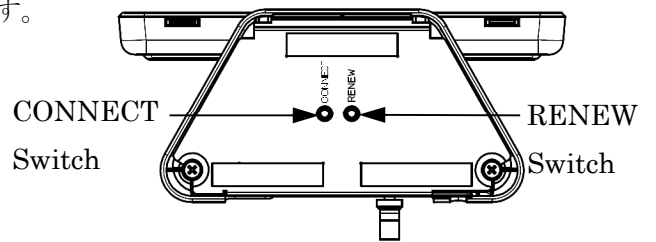

3-4-3. BT_CONNECT_SW

CONNECT スイッチを押すことで、本製品から最後に接続した iOS 機器へ再接続を開始する信号を送信します。

Pressing CONNECT switch, module will send the Launch command of iOS applications to iOS devices.

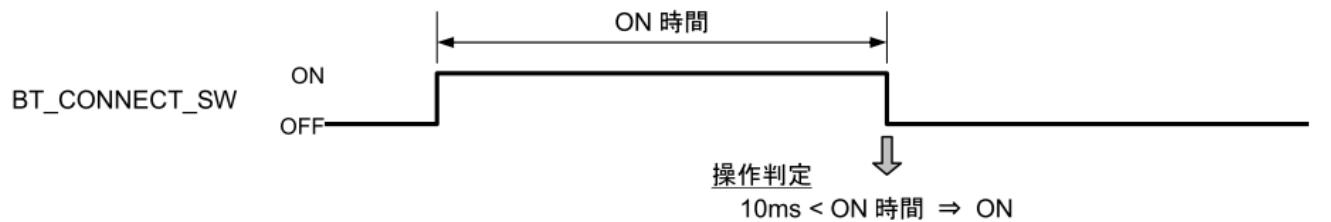

3-3-5. iAP Accessory 設定 iAP ACCESSORY SETTINGS

Table-20

Parameter	Specification
Profile Settings	3 (iAP Enable)
Data Transmission Mode	0 (iAP Data Through Mode)
Autonomous Launch	0 (Disable Autonomous launch)
Accessory Incoming Max Payload Size	400
Accessory name	“Slim design display”
Manufacturer	“Futaba Corporation”
Model Number	“AH148AC” or “AH148BC”
Serial Number	“0000001”~
Firmware version	1. 0. 0
Hardware version	1. 0. 0
Protocol string	“com.futaba.protocol”
Protocol MetadataType	2
Bundle seed ID number	“ASLQTPDR6Q”
Application Bundle ID String	“com.futaba.app”
Accessory RF Certifications	0
Maximum Number of Outstanding Packets	5
Cumulative Acknowledgements	3, 0x03E8

3-3-6. セキュリティ仕様 SECURITY SPECIFICATION

Table-21

項目 Parameter	仕様 Specification
固定 PIN Code Fixed PIN Code	0000
セキュリティ設定 Security setting	1

3-3-7. ペ어링仕様 PAIRING SPECIFICATION

ペ어링情報データベースは最大 8 台までのペ어링情報が登録可能です。

ペ어링情報には接続履歴が含まれます。接続履歴は、最後に接続した相手が最新となるよう、接続をする度に並び替えを行います。8 台を超えてペ어링を行うと、最も古く接続した相手のペ어링情報を削除し、新しく接続した相手のペ어링情報を追加します。

Max 8 pairing information can be registered in the pairing information database. Pairing information is included in connection history. The connection history is rearranged each time the connection is made so that the last connected party becomes the latest. When more than 8 pairing is performed, the pairing information of the oldest connected party is deleted, and the pairing information of the newly connected opponent is added.

4. コマンド COMMAND

本モジュールは、以下のコマンドを有します。

The followings are all commands of this module.

No.	Command	Byte	1st	2nd	3rd	4th	5th	6th	7th	8th	9th	10th	11th	12th ~
1	BACKSPACE	1	08h											
2	HORIZONTAL TAB	1	09h											
3	LINE FEED	1	0Ah											
4	CARRIAGE RETURN	1	0Dh											
5	SET COUNTRY CODE	3	1Bh	52h	<i>n</i>									
6	DELETE TO END OF LINE	4	1Bh	5Bh	30h	4Bh								
7	MODULE INFORMATION RESPONSE	4	1Bh	5Bh	30h	63h								
8	CLEAR SCREEN	4	1Bh	5Bh	32h	4Ah								
9	HOME POSITION	4	1Bh	5Bh	48h	27h								
10	TURN ON/OFF DISPLAY	4	1Bh	5Bh	<i>n</i>	50h								
11	SPECIFIED POSITION	6	1Bh	5Bh	<i>Py</i>	3Bh	<i>Px</i>	48h						
12	CURSOR MODE	6	1Bh	5Ch	3Fh	4Ch	43h	<i>Ps</i>						
13	LCD CONTRAST & VFD BRIGHTNESS	7	1Bh	5Ch	3Fh	4Ch	44h	<i>Pc</i>	<i>Pb</i>					
14	USER DEFINED CHARACTERS	27 or 44	1Bh	5Ch	3Fh	4Ch	57h	<i>Pf</i>	3Bh	<i>Pn</i>	3Bh	<i>Pc</i>	3Bh	<i>Pd ...</i>

Table - 22

4-1. コマンド詳細 FUNCTION OF COMMANDS

本製品の制御コマンドは以下の通りです。Following is the details of each command.

4-1-1. BACKSPACE

Code: 08h

MSB

LSB

Table - 23

Code	Byte	Bit7	Bit6	Bit5	Bit4	Bit3	Bit2	Bit1	Bit0	Note
08h	1st	0	0	0	0	1	0	0	0	

Function: Moves the cursor one character position to the left.

When the cursor is at the left end of the lower line, it is moved to the right end of the upper line. When it is at the left end of the upper line, it is moved to the right end of the lower line.

機能: カーソルを1文字左に移動します。

カーソルが下段の左端にある場合、上段の右端に移動します。上段の左端にある場合は、下段の右端に移動します。

[Example]

//Before command is sent

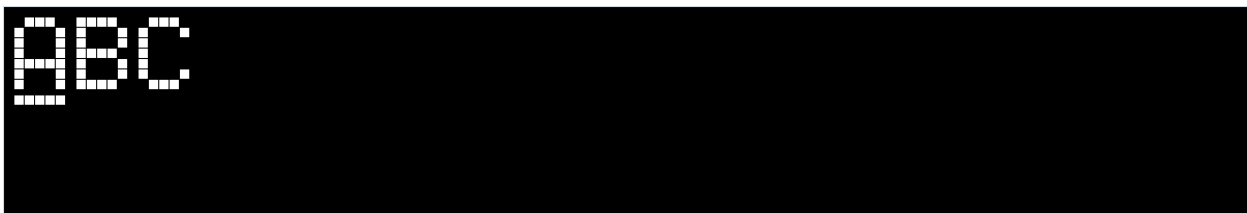

//Send command

Send(08h);

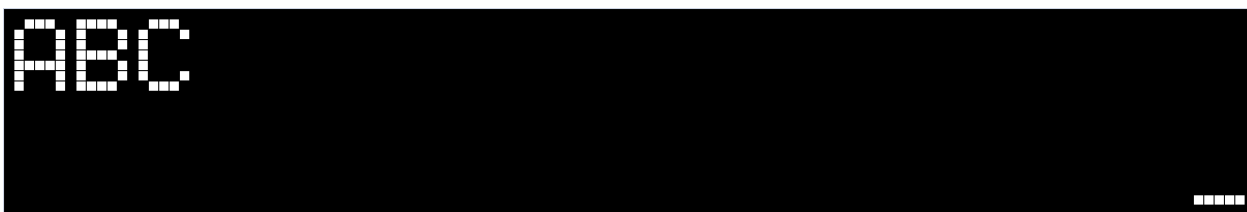

4-1-2. HORIZONTAL TAB

Code: 09h

MSB

LSB

Table - 24

Code	Byte	Bit7	Bit6	Bit5	Bit4	Bit3	Bit2	Bit1	Bit0	Note
09h	1st	0	0	0	0	1	0	0	1	

Function: Moves the cursor one character position to the right.

When the cursor is at the right end of the upper line, it is moved to the left end of the lower line. When it is at the right end of the lower line, it is moved to the left end of the upper line.

機能: 右にカーソルを1文字位置を移動します。

カーソルが下段の右端にある場合、上段の左端に移動します。上段の右端にある場合は、下段の左端に移動します。

[Example]

//Before command is sent

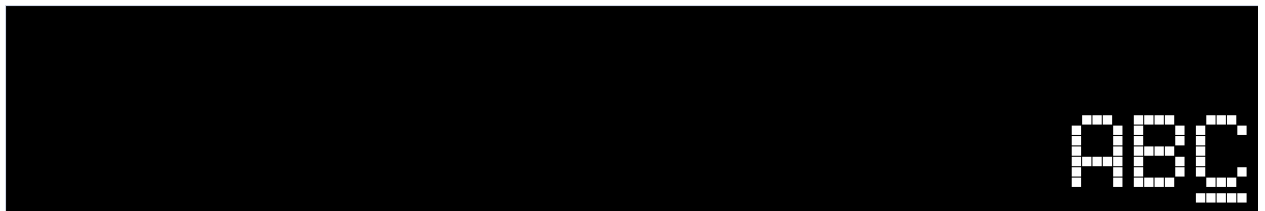

//Send command

Send(09h);

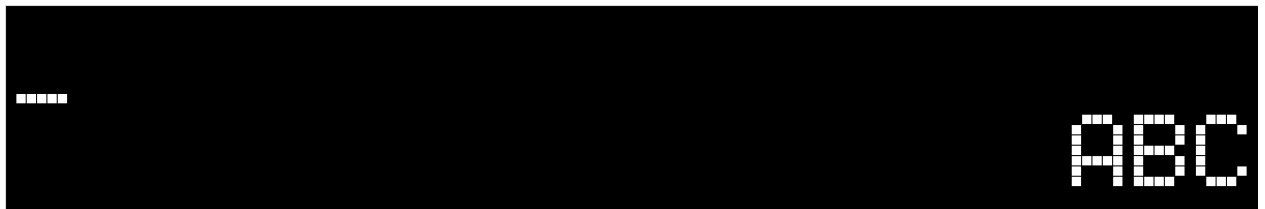

4-1-3. LINE FEED

Code: 0Ah

MSB

LSB

Table - 25

Code	Byte	Bit7	Bit6	Bit5	Bit4	Bit3	Bit2	Bit1	Bit0	Note
0Ah	1st	0	0	0	0	1	0	1	0	

Function: Moves the cursor down one line

If the cursor is in the lower line, the cursor moves to the same column on the upper.

機能: 1段下にカーソルを移動します。桁は同じ位置になります。カーソルが下段にあるとき、上段に移動します。

[Example]

//Before command is sent

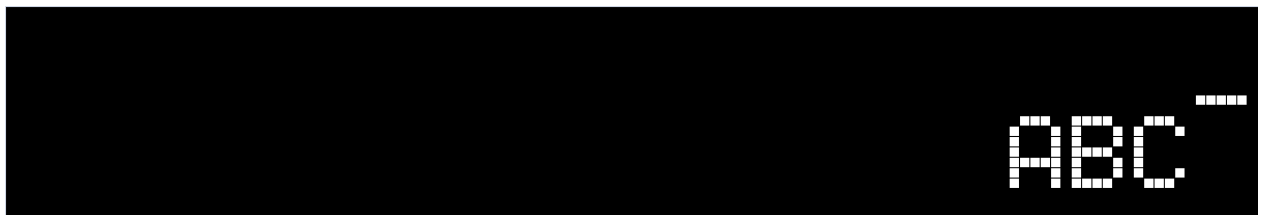

//Send command

Send(0Ah);

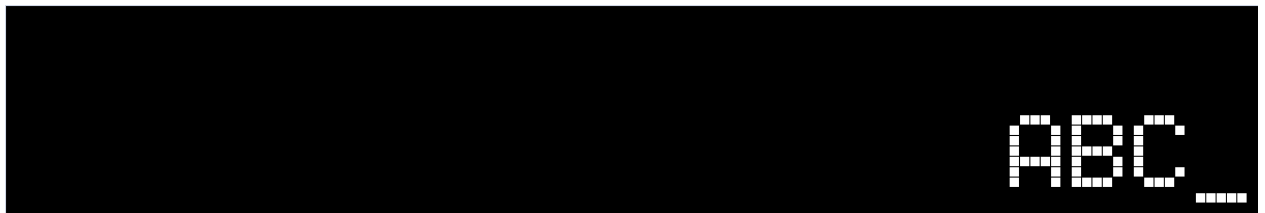

4-1-4. CARRIAGE RETURN

Code: 0Dh

MSB

LSB

Table - 26

Code	Byte	Bit7	Bit6	Bit5	Bit4	Bit3	Bit2	Bit1	Bit0	Note
0Dh	1st	0	0	0	0	1	1	0	1	

Function: Moves the cursor to the left-most position on current line.

機能: カーソルを現在ある段の左端に移動させます。

[Example]

//Before command is sent

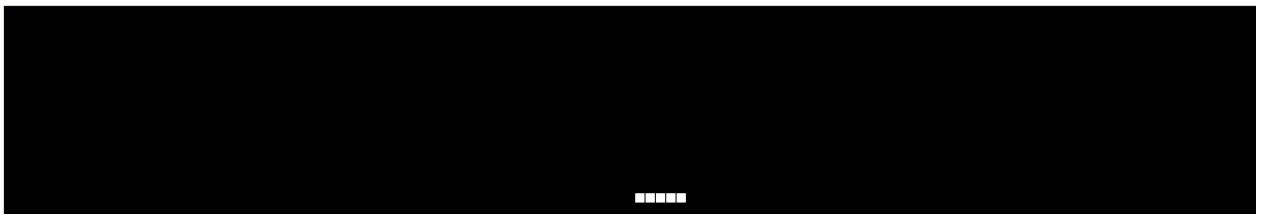

//Send command

Send(0Dh);



4-1-6. SET COUNTRY CODE

Code: 1Bh, 52h, n

Code	Byte	MSB				LSB				Note
		Bit7	Bit6	Bit5	Bit4	Bit3	Bit2	Bit1	Bit0	
1Bh	1st	0	0	0	1	1	0	1	1	
52h	2nd	0	1	0	1	0	0	1	0	
n	3rd	0	0	n	n	n	n	n	n	00h ≤ n ≤ 0Dh, 30h ≤ n ≤ 39h

Table - 27

Function : Select international font set. (Please refer international Font Set Table.).00h ≤ n ≤ 0Dh. The default setting is 00h(USA) and 30h(PC437).

機能： フォントテーブルを00(h) ≤ n ≤ 0D(h), 30(h) ≤ n ≤ 39(h)から選択します。後述のフォントテーブルをご参照ください。電源投入時の初期設定は、00h(USA)、30h(PC437)です。

00h～0Dh: Character code 20h-7Fh

30h～39h: Character code 80h-FFh

Table -28

n	Country Code (20h – 7Fh)	n	Country Code (80h - FFh)
00h	USA – default	30h	PC437 (USA: Standard Europe) – default
01h	France	31h	Katakana
02h	Germany	32h	PC850 (Multilingual)
03h	Great Britain	33h	PC860 (Portuguese)
04h	Denmark 1	34h	PC863(Canadian-French)
05h	Sweden	35h	Page 5 [PC865 (Norwegian)]
06h	Italy	36h	WPC1252
07h	Spain 1	37h	PC866 [Cyrillic #2]
08h	Japan	38h	PC852 [Latin 2]
09h	Norway	39h	Page 19 [PC858]
0Ah	Denmark 2		
0Bh	Spain 2		
0Ch	Latin America		
0Dh	Korea		

4-1-7. DELETE TO END OF LINE

Code: 1Bh, 5Bh, 30h, 4Bh

MSB

LSB

Table - 29

Code	Byte	Bit7	Bit6	Bit5	Bit4	Bit3	Bit2	Bit1	Bit0	Note
1Bh	1st	0	0	0	1	1	0	1	1	
5Bh	2nd	0	1	0	1	1	0	1	1	
30h	3rd	0	0	1	1	0	0	0	0	
4Bh	4th	0	1	0	0	1	0	1	1	

Function: Clears the line containing the cursor.

After this command is executed, the cursor moves to the left-most position on the current line.

機能: カーソルのある段を消去します。

このコマンドを実行した後、カーソルは左端へ移動します。

[Example]

//Before command is sent



//Send command

`send(1Bh, 5Bh, 30h, 4Bh);`



4-1-8. MODULE INFORMATION RESPONSE

Code: 1Bh, 5Bh, 30h, 63h

Code	Byte	MSB				LSB				Note
		Bit7	Bit6	Bit5	Bit4	Bit3	Bit2	Bit1	Bit0	
1Bh	1st	0	0	0	1	1	0	1	1	
5Bh	2nd	0	1	0	1	1	0	1	1	
30h	3rd	0	0	1	1	0	0	0	0	
63h	4th	0	1	0	1	0	0	0	0	

Table – 30

Function: Module information response command.

The data send from this module is the below.

機能: モジュール情報をホストに送信するコマンドです。

本製品からホストに送信するデータは以下になります。

Table -31

Response data
4C 43 44 5F 41 4E 4B 5F 32 30 78 32 (LCD_DOT_20x2)

4-1-9. CLEAR SCREEN

Code: 1Bh, 5Bh, 32h, 4Ah

MSB

LSB

Table - 32

Code	Byte	Bit7	Bit6	Bit5	Bit4	Bit3	Bit2	Bit1	Bit0	Note
1Bh	1st	0	0	0	1	1	0	1	1	
5Bh	2nd	0	1	0	1	1	0	1	1	
32h	3rd	0	0	1	1	0	0	1	0	
4Ah	4th	0	1	0	0	1	0	1	0	

Function: Clears all displayed characters.

After this command is executed, the cursor moves to the home position.

機能: ディスプレイされている文字を全消去します。

このコマンドを実行した後、カーソルはホームポジションへ移動します。

[Example]

//Before command is sent

//Send command

Send(1Bh, 5Bh, 32h, 4Ah);

4-1-10. HOME POSITION

Code: 1Bh, 5Bh, 48h, 27h

MSB

LSB

Table - 33

Code	Byte	Bit7	Bit6	Bit5	Bit4	Bit3	Bit2	Bit1	Bit0	Note
1Bh	1st	0	0	0	1	1	0	1	1	
5Bh	2nd	0	1	0	1	1	0	1	1	
48h	3rd	0	1	0	0	1	0	0	0	
27h	4th	0	0	1	0	0	1	1	1	

Function: Moves the cursor to the left-most position on the upper line (home position).

The home position indicates the first column of the upper line.

機能: ホームポジションの位置にカーソルを移動します。

ホームポジションは、上段の最初の桁を示します。

[Example]

//Before command is sent

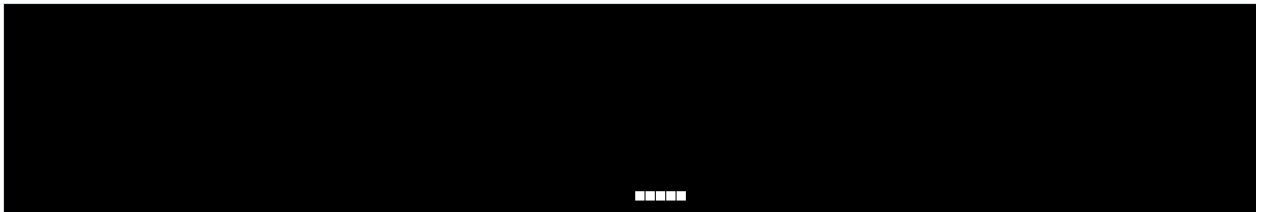

//Send command

Send(1Bh, 5Bh, 48h, 27h);

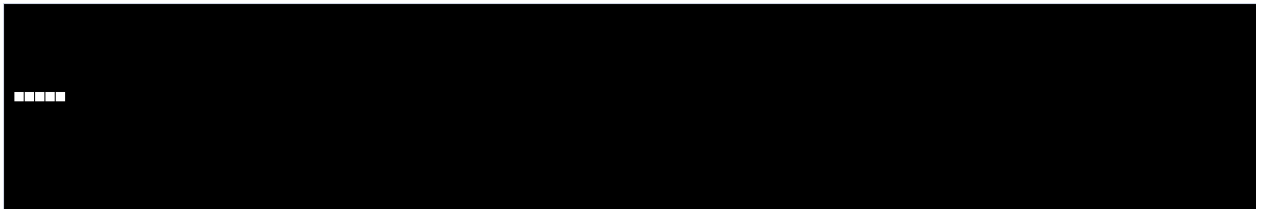

4-1-11. TURN ON/OFF DISPLAY

Code: 1Bh, 5Bh, n, 50h

Code	Byte	MSB					LSB			Note
		Bit7	Bit6	Bit5	Bit4	Bit3	Bit2	Bit1	Bit0	
1Bh	1st	0	0	0	1	1	0	1	1	
5Bh	2nd	0	1	0	1	1	0	1	1	
n	3rd	0	0	0	0	0	0	0	n	$00h \leq n \leq 01h.$
50h	4th	0	1	0	1	0	0	0	0	

3rd byte	Bit0	Note
	0	Display OFF
	1	Display ON (Default)

Function: Back light power ON/OFF control command. If n=0, Back light power is OFF, if n=1, Back light power is ON. The state of display power ON/OFF is valid until next command of power or soft reset.

機能: LCDのバックライトON/OFFを制御するコマンドです。n = 0 でバックライトはOFF、n = 1 でバックライトはONとなります。ON/OFFの状態は再度このコマンドを送信するか、初期化されるまで続きます。

4-1-12. SPECIFIED POSITION

Code: 1Bh, 5Bh, Py, 3Bh, Px, 48h

Code	Byte	MSB					LSB			Note
		Bit7	Bit6	Bit5	Bit4	Bit3	Bit2	Bit1	Bit0	
1Bh	1st	0	0	0	1	1	0	1	1	
5Bh	2nd	0	1	0	1	1	0	1	1	
Py	3rd	0	0	0	0	0	0	Py	Py	$01h \leq Py(\text{column}) \leq 02h$.
3Bh	4th	0	0	1	1	1	0	1	1	
Px	5th	0	0	0	Px	Px	Px	Px	Px	$01h \leq Px(\text{row}) \leq 14h$.
48h	6th	0	1	0	0	1	0	0	0	

2nd byte	Bit2	Bit1	Bit0	Start write on top position
	0	0	1	01h
	0	1	0	02h

5th byte	Bit7	Bit6	Bit5	Bit4	Bit3	Bit2	Bit1	Bit0	Start write on left position
	0	0	0	0	0	0	0	1	01h
	0	0	0	0	0	0	1	0	02h
	:								
	0	0	0	1	0	0	1	1	13h
	0	0	0	1	0	1	0	0	14h

Function: Moves the cursor to the x th position on the y th line.

If the command specifies a value for n or m that exceeds the range, this command is ignored, and the cursor is not moved.

機能: Py段のPx桁目の位置にカーソルを移動します。

コマンドが範囲を超えたPy、Pxの値を指定している場合、このコマンドは無視されカーソルは移動しません。

4-1-13. CURSOR MODE

Code: 1Bh, 5Ch, 3F, 4Ch, 43, Ps

Code	Byte	MSB						LSB		Note
		Bit7	Bit6	Bit5	Bit4	Bit3	Bit2	Bit1	Bit0	
1Bh	1st	0	0	0	1	1	0	1	1	
5Ch	2nd	0	1	0	1	1	1	0	0	
3Fh	3rd	0	0	1	1	1	1	1	1	
4Ch	4th	0	1	0	0	1	0	1	1	
43h	5th	0	1	0	0	0	0	1	1	
Ps	6th	0	0	0	0	0	0	Ps	Ps	$00h \leq Ps \leq 02h.$

6th byte	Bit1	Bit0	Start write on top position
0	0	0	Ps = 00h: Cursor OFF (Default)
0	1	0	Ps = 01h: Cursor blink
1	0	0	Ps = 02h: Cursor ON

Function: Selects or cancels the cursor display.

When Ps = 1, the cursor blinks. When Ps = 2, the cursor will continue to light up. Cursor at Ps = 0 will turn off.

機能: カーソルの表示・非表示を設定します。

Ps = 1のとき、カーソルは点滅します。Ps = 2のとき、カーソルは点灯し続けます。Ps = 0でカーソルは消灯します。

4-1-14. LCD CONTRAST & VFD BRIGHTNESS

Code: 1Bh, 5Ch, 3Fh, 4Ch, 44h, Pc, Pb

Code	Byte	MSB					LSB				Note
		Bit7	Bit6	Bit5	Bit4	Bit3	Bit2	Bit1	Bit0		
1Bh	1st	0	0	0	1	1	0	1	1		
5Ch	2nd	0	1	0	1	1	1	0	0		
3Fh	3rd	0	0	1	1	1	1	1	1		
4Ch	4th	0	1	0	0	1	1	0	0		
44h	5th	0	1	0	0	0	1	0	0		
Pc	6th	0	0	0	0	0	Pc	Pc	Pc	$00h \leq Pc \leq 06h$	
Pb	7th	0	0	0	0	0	0	Pb	Pb	$00h \leq Pb \leq 03h$ ※	

Function: LCD contrast and VFD brightness adjustment.

Pc set up the LCD contrast. (Table-38)

Pb set up the VFD brightness. (Table-39)

※This module doesn't set up VFD brightness. Please set the Pb = 03h.

機能: LCDのコントラストとVFDの輝度を設定します。

LCDのコントラストは、Pcの値で設定します。(Table-38)

VFDの輝度は、Pbの値で設定します。(Table-39)

※本品種ではVFDの輝度設定を使用しないため、Pbの値はPb=03hと設定してください。

Table - 38

Pc	LCD Contrast
00h	-3
01h	-2
02h	-1
03h	0 (Default)
04h	+1
05h	+2
06h	+3

Table - 39

Pb	VFD Brightness (%)
00h	20
01h	40
02h	60
03h	100 (Default) ※

4-1-15. USER DEFINED CHARACTERS

Code: 1Bh, 5Ch, 3Fh, 4Ch, 57h, Pf, 3Bh, Pn, 3Bh, Pc, 3Bh, Pd ...

Table - 40

Code	Byte	MSB					LSB				Note
		Bit7	Bit6	Bit5	Bit4	Bit3	Bit2	Bit1	Bit0		
1Bh	1st	0	0	0	1	1	0	1	1		
5Ch	2nd	0	1	0	1	1	1	0	0		
3Fh	3rd	0	0	1	1	1	1	1	1		
4Ch	4th	0	1	0	0	1	1	0	0		
57h	5th	0	1	0	1	0	1	1	1		
Pf	6th	0	0	0	0	0	0	Pf	Pf	Pf=01h	
3Bh	7th	0	0	1	1	1	0	1	1		
Pn	8th	0	0	0	Pn	Pn	Pn	Pn	Pn	00h ≤ Pn ≤ 1Fh (Pf = 01h)	
3Bh	9th	0	0	1	1	1	0	1	1		
Pc	10th	Pc	Pc	Pc	Pc	Pc	Pc	Pc	Pc	20h ≤ Pc ≤ 7Fh (Pf = 01h)※ 80 00h ≤ Pc ≤ FF FFh (Pf = 02h)	
3Bh	11th	0	0	1	1	1	0	1	1		
Pd	12th~	Pd	Pd	Pd	Pd	Pd	Pd	Pd	Pd	5 byte	

Function: Defines user-defined characters.

User-defined character that was defined will be displayed by the character code of the Pc. User-defined character font data to be secured on the RAM, are cleared by power-off. The maximum number of characters that can be registered in each font size is below. If the user-defined character is already registered in the specified font number, to release that character and make a new user-defined character.

Pf = 01h: One-byte character 5×7 → Maximum 32 characters

•Font size (Pf = 1), if you specify the 00h to the character code(Pc), and then release the user-defined character that is registered with the given font number.

Pf = 1 (01h) : 1Bh, 5Ch, 3Fh, 4Ch, 57h, Pf, 3Bh, Pn, 3Bh, 00h,3Bh

機能: 外字を定義します。

定義した外字は Pc の文字コードにより表示されます。外字フォントデータは RAM 上に確保されるため、電源遮断により消去されます。各フォントサイズで登録できる最大の文字数は以下となります。指定されたフォント番号に既に外字が登録されている場合、登録されている外字を解除し新たに外字登録を行います。

Pf = 1(01H) : 5×7 dot 文字 5×7 最大 32 文字

•文字コード(Pc)に 00h (Pf = 1) 指定した場合、指定されたフォント番号に登録されている外字を解除します。

Pf = 1 (01h) : 1Bh, 5Ch, 3Fh, 4Ch, 57h, Pf, 3Bh, Pn, 3Bh, 00h,3Bh

<i>Pf</i> : Font size フォントサイズ	<i>Pf</i> = 01h : One-byte character 5×7 dot
<i>Pn</i> : Font number フォント番号	00h ≤ <i>Pn</i> ≤ 1Fh (<i>Pf</i> = 01h)
<i>Pc</i> : Character code 文字コード	20h ≤ <i>Pc</i> ≤ 7Fh (<i>Pf</i> = 01h)
<i>Pd</i> : Font data フォントデータ	5 byte (<i>Pf</i> = 01h)

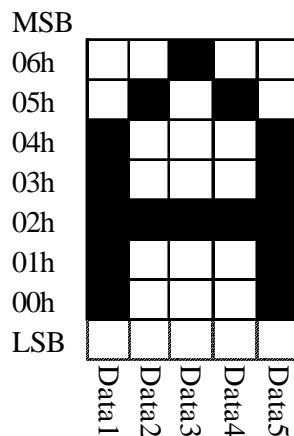
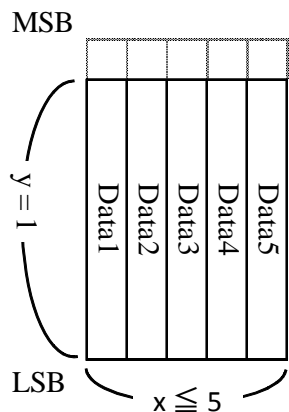

Byte	1	2	3	4	5
Data	1Fh	24h	44h	24h	1Fh

5. コネクタ接続 CONECTER CONNECTION

5-1. RS232C TYPE (AH148AA/BA)

本体 CN1 : HEC3650-018010 EIAJ-2 or equivalent

CN2 : DSB5-09M1-KNR0-02 D-SUB 9pin male connector or equivalent

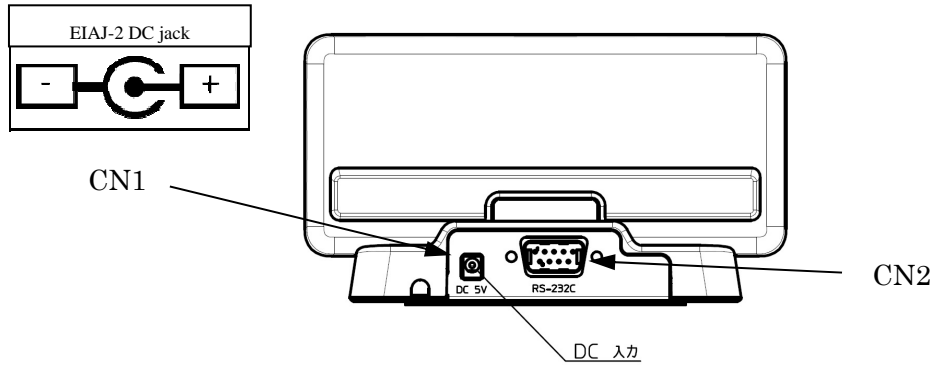

CN2 PIN 配置

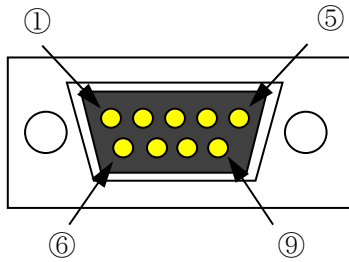

ピン番号 PIN NO.	信号名 Signal Name
1	—
2	RxD
3	TxD
4	—
5	GND
6	—
7	RTS
8	CTS
9	—

5-2. USB TYPE (AH148AB/BB)

本体 CN1 : UX60SC-MB-5ST USB Mini-B female connector or equivalent

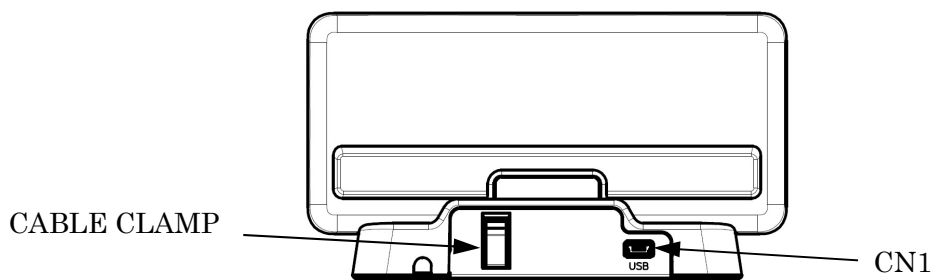

CN1 PIN 配置

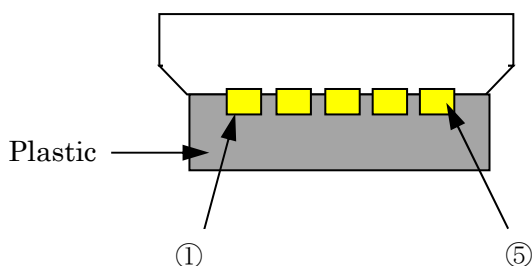

ピン番号 PIN NO.	信号名 Signal Name
1	Vcc (Vbus)
2	D-
3	D+
4	NC
5	GND

CABLE SPECIFICATION

線径 (Vbus,GND) : AWG24
 線径 (D+,D-) : AWG28
 色 : 白と黒の2種類
 MINIBコネクタ: レフトアングル
 TYPEAコネクタ: ストレート

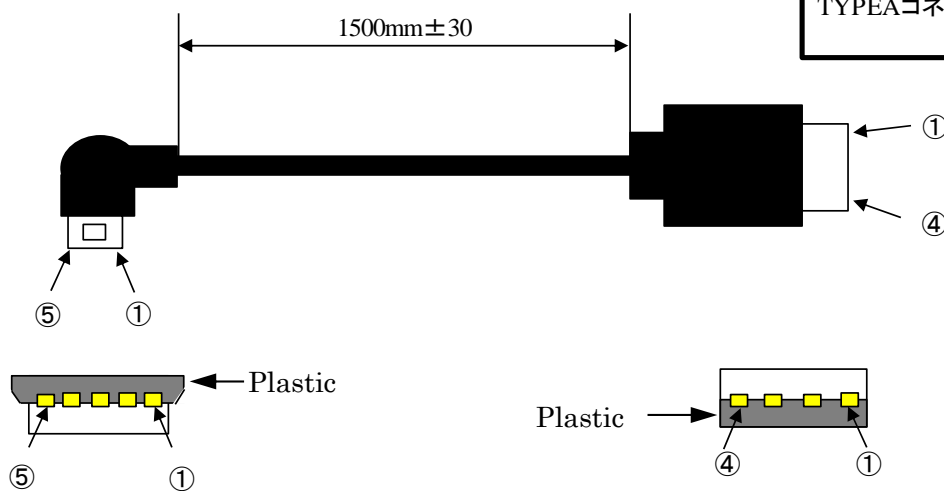

USB Mini-B		USB Type A	
PIN no.	Signal name	PIN no.	Signal name
1	Vcc(Vbus)	1	Vcc(Vbus)
2	D-	2	D-
3	D+	3	D+
4	NC	4	GND
5	GND	SEHLL	FGND
SHELL	FGND		

5-3. BLUETOOTH iAP TYPE (AH148AC/BC)

本体 CN1 : UX60SC-MB-5ST USB Mini-B female connector or equivalent

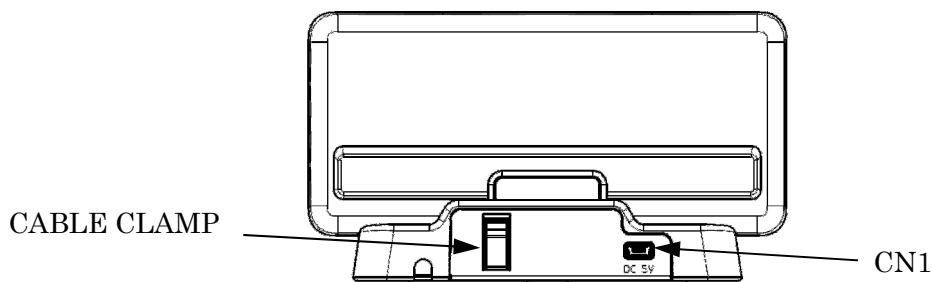

CN1 PIN 配置

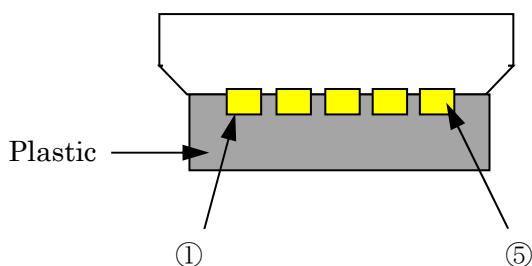

ピン番号 PIN NO.	信号名 SIGNAL NAME
1	Vcc (Vbus)
2	NC (D-)
3	NC (D+)
4	NC
5	GND

CABLE SPECIFICATION

線径 (Vbus,GND) : AWG24
 線径 (D+,D-) : AWG28
 色 : 白と黒の2種類
 MINIBコネクタ: レフトアングル
 TYPEAコネクタ: ストレート

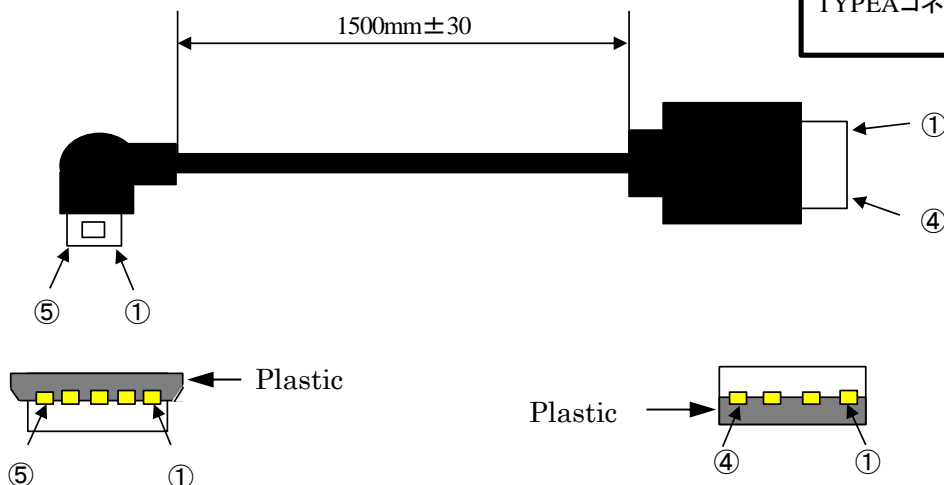

USB Mini-B		USB Type A	
PIN no.	Signal name	PIN no.	Signal name
1	Vcc(Vbus)	1	Vcc(Vbus)
2	D-	2	D-
3	D+	3	D+
4	NC	4	GND
5	GND	SEHLL	FGND
SHELL	FGND		

Outer Dimensions

FIGURE-1

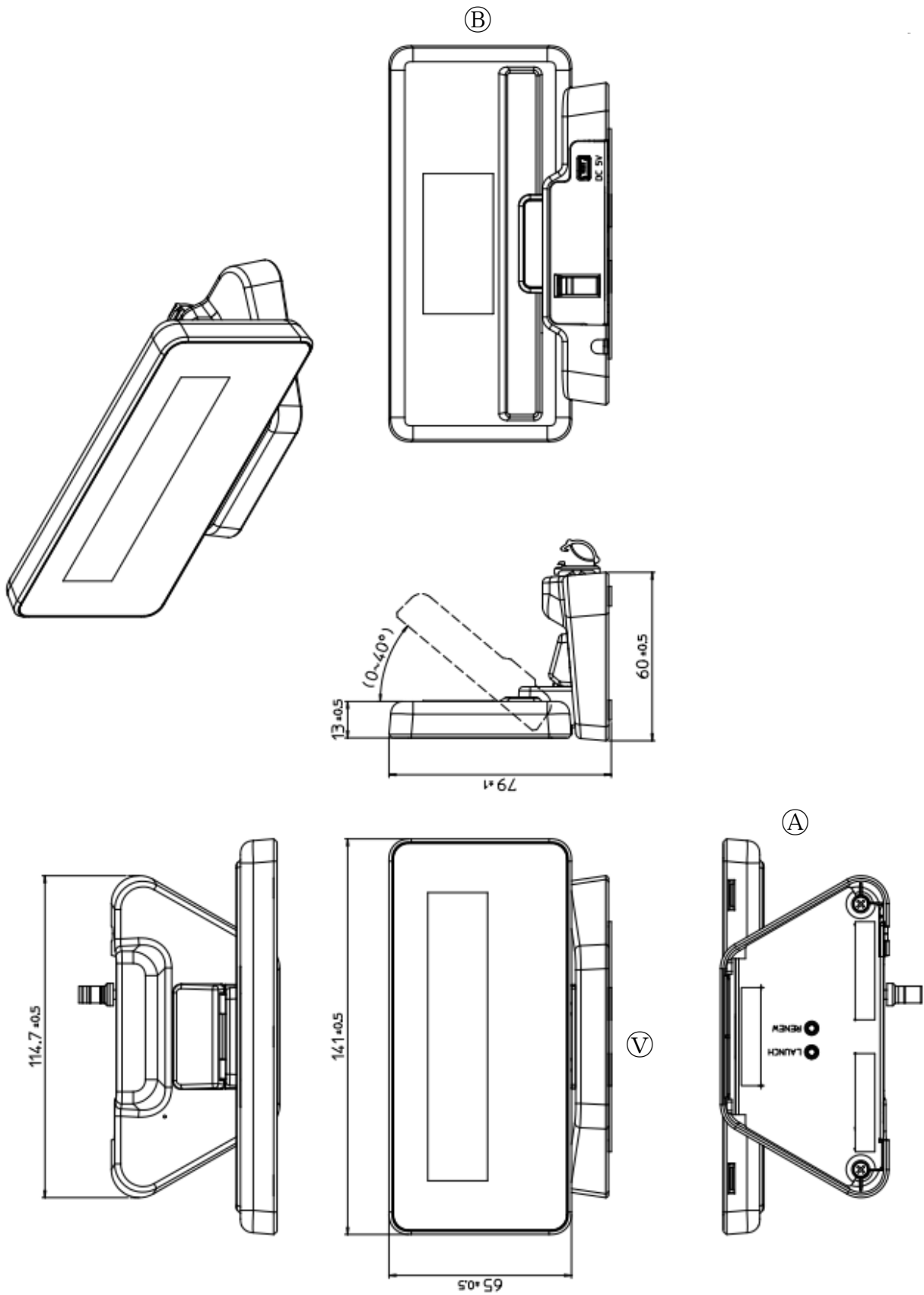

Outer Dimensions

FIGURE-2

RS232C TYPE (AH148AA/BA)

Ⓐ

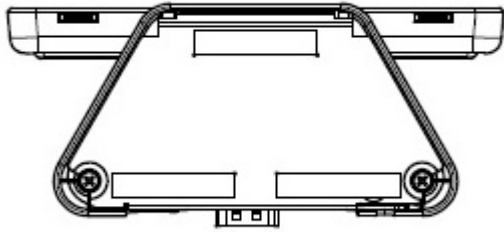

Ⓑ

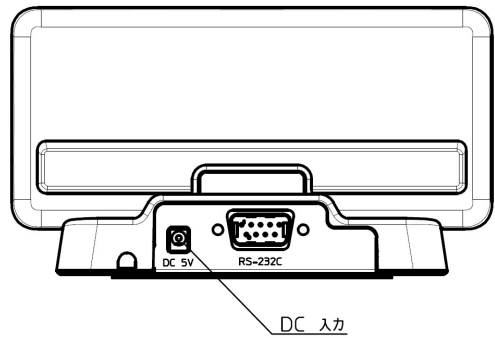

USB TYPE (AH148AB/BB)

Ⓐ

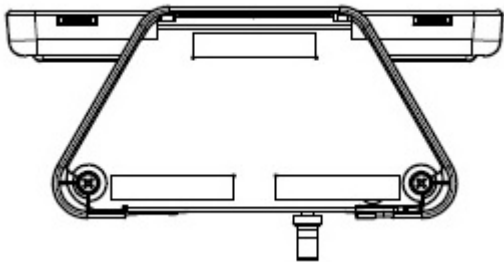

Ⓑ

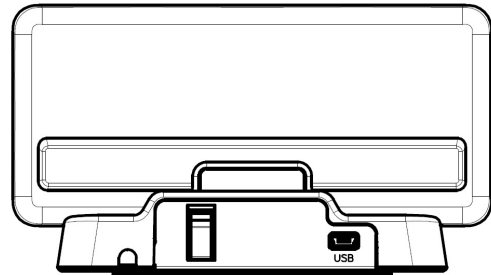

BLUETOOTH (iAP) TYPE (AH148AC/BC)

Ⓐ

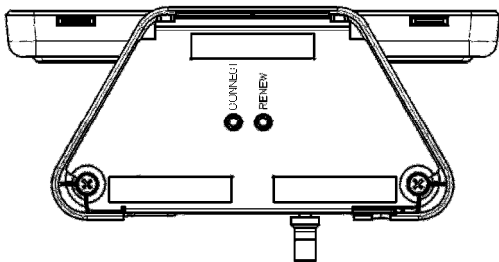

Ⓑ

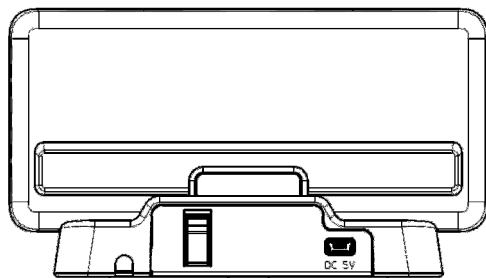

RS232C Type (AH148AA/BA) Block Diagram

FIGURE-3

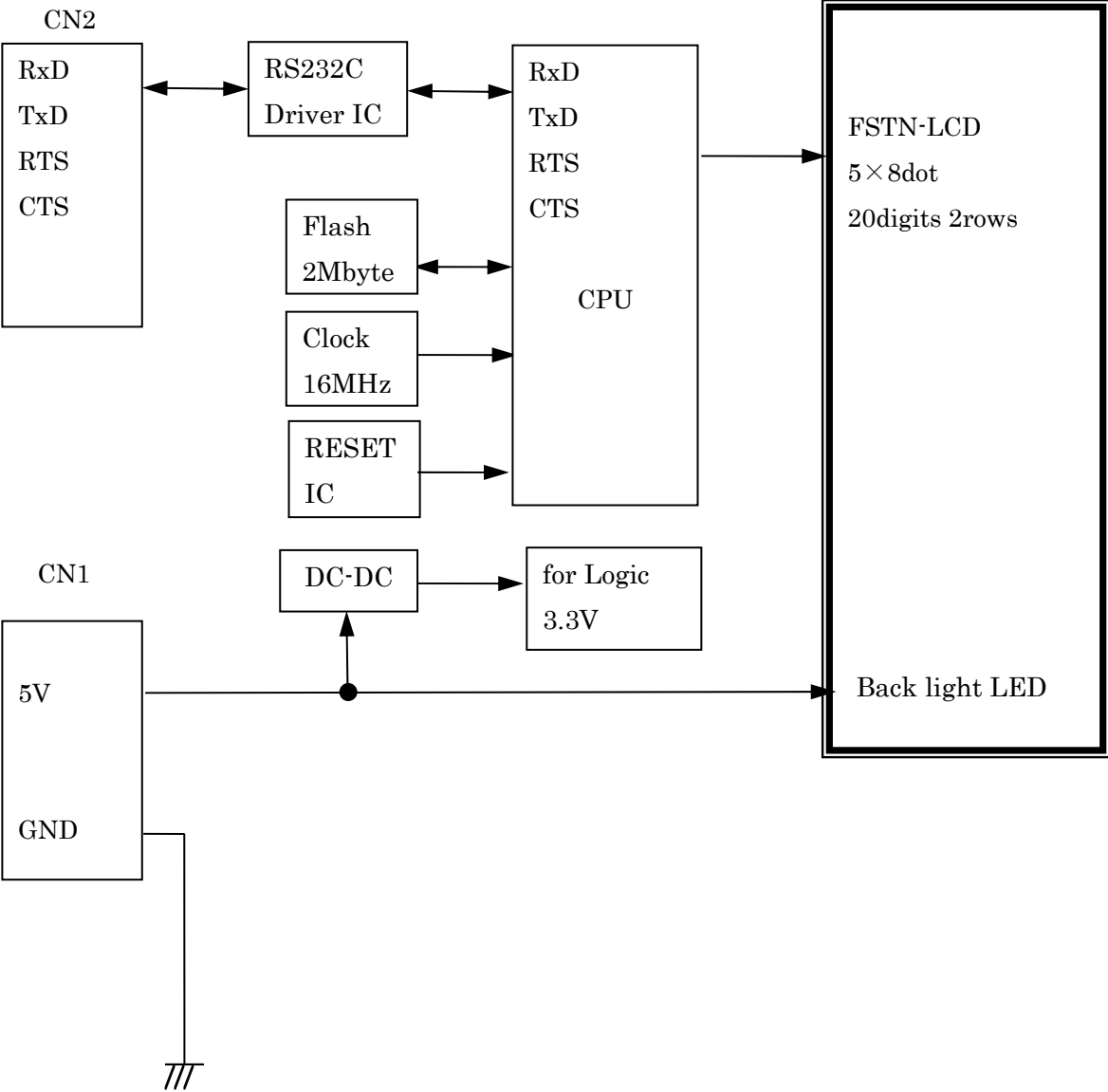

USB Type (AH148AB/BB) Block Diagram

FIGURE-4

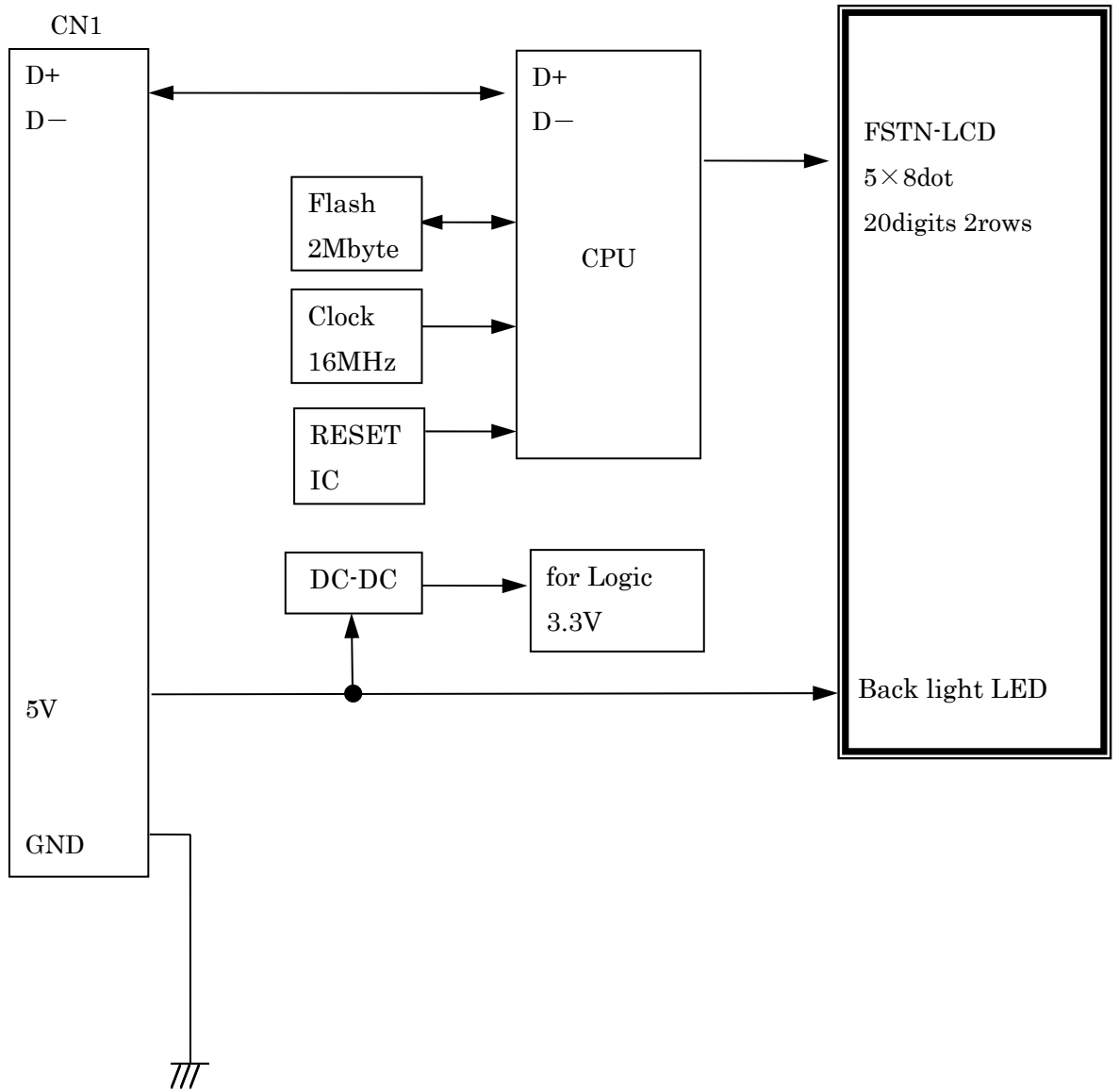

BLUETOOTH(iAP) Type (AH148AC/BC) Block Diagram

FIGURE-5

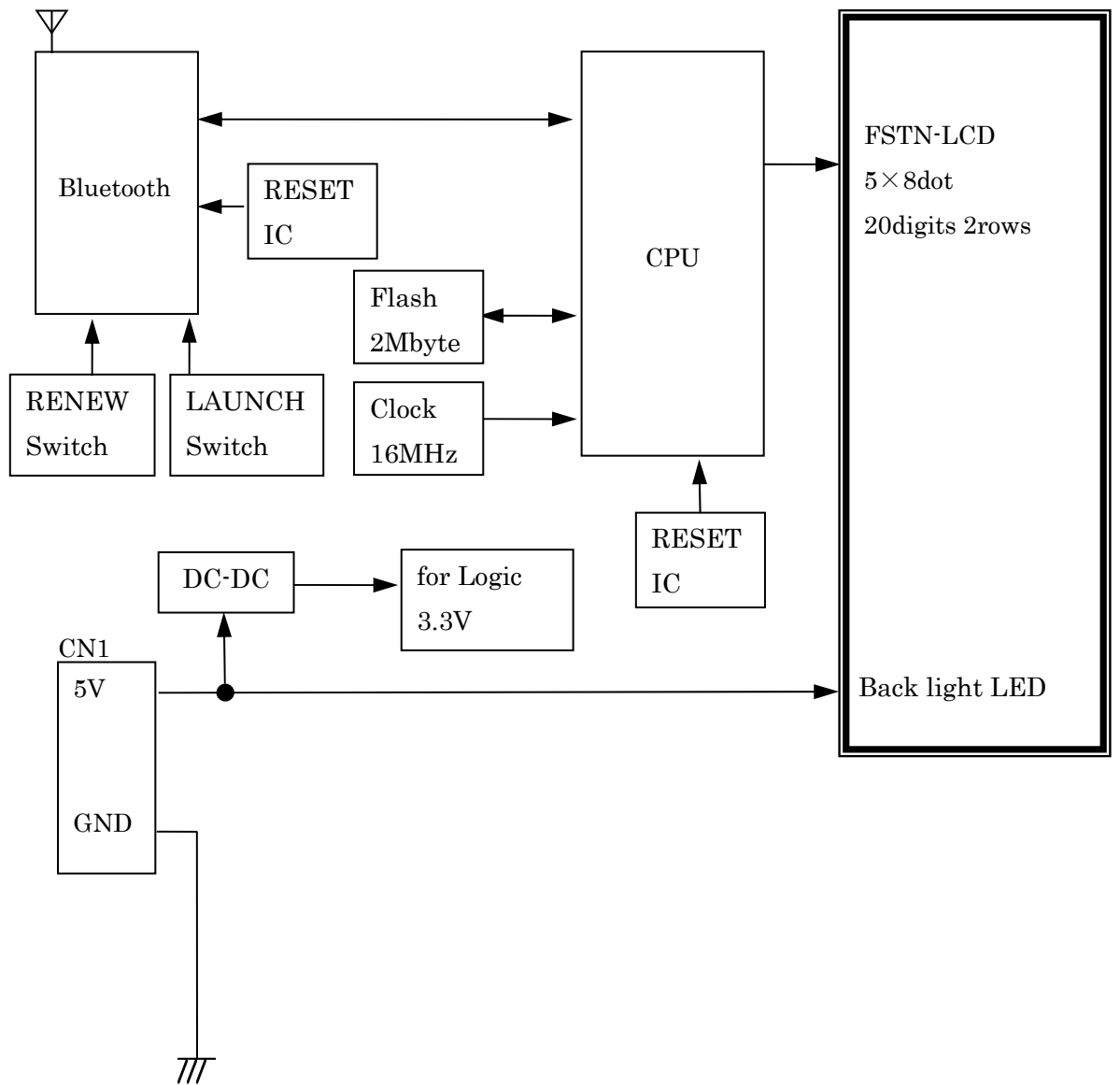

Font Tables

Common font

	0	1	2	3	4	5	6	7	8	9	A	B	C	D	E	F
2		!	"	#	\$	%	&	'	()	*	+	,	-	.	/
3	0	1	2	3	4	5	6	7	8	9	:	;	<	=	>	?
4	@	A	B	C	D	E	F	G	H	I	J	K	L	M	N	O
5	P	Q	R	S	T	U	V	W	X	Y	Z	[\]	^	_
6	`	a	b	c	d	e	f	g	h	i	j	k	l	m	n	o
7	p	q	r	s	t	u	v	w	x	y	z	{		}	~	

International font set

n	23	24	40	5B	5C	5D	5E	60	7B	7C	7D	7E
00	#	\$	@	[\]	^	`	{		}	~
01	#	\$	à	°	ç	§	^	`	é	ù	è	¨
02	#	\$	ÿ	ä	ö	ü	^	`	ä	ö	ü	ß
03	£	\$	@	[\]	^	`	{		}	~
04	#	\$	@	Æ	Ø	Å	^	`	æ	ø	å	~
05	#	¤	é	ä	ö	å	ü	é	ä	ö	å	ü
06	#	\$	@	°	\	é	^	ù	à	ò	è	ì
07	£	\$	@	ì	ñ	¿	^	`	¨	ñ	}	~
08	#	\$	@	[¥]	^	`	{		}	~
09	#	¤	é	Æ	Ø	Å	Ü	é	æ	ø	å	Ü
0A	#	\$	é	Æ	Ø	Å	Ü	é	æ	ø	å	Ü
0B	#	\$	á	í	ñ	¿	é	`	í	ñ	ó	ú
0C	#	\$	á	í	ñ	¿	é	ü	í	ñ	ó	ú
0D	#	\$	@	[¥]	^	`	{		}	~

n=30h

	0	1	2	3	4	5	6	7	8	9	A	B	C	D	E	F	
8	Œ	Ü	é	â	ä	à	á	Œ	é	ë	è	ï	î	ì	ä	â	
9	É	æ	Æ	ô	ö	ò	ó	ù	ÿ	ö	ü	¢	£	¥	₹	₪	
A	á	í	ó	ú	ñ	ñ	œ	œ	¿	¬	¼	½	¾	¿	»	»	
B	⋮	⋈	⋉		+	+	+	π	π	π	π	π	π	π	π	π	π
C	⊥	⊥	⊥	⊥	⊥	⊥	⊥	⊥	⊥	⊥	⊥	⊥	⊥	⊥	⊥	⊥	⊥
D	⊥	⊥	⊥	⊥	⊥	⊥	⊥	⊥	⊥	⊥	⊥	⊥	⊥	⊥	⊥	⊥	⊥
E	α	β	Γ	π	Σ	σ	μ	τ	Φ	Θ	Ω	δ	ω	ψ	ε	Π	
F	≡	±	≥	≤	↑	↓	÷	∞	°	·	·	√	n	2	■		

n=31h

	0	1	2	3	4	5	6	7	8	9	A	B	C	D	E	F
8	—	—	—	■	■	■	—	—	—	■	■	■				
9					■	⋈	⋉	→	←	↑	↓	×	÷	±	≤	≥
A		。	「	」	、	・	ヲ	ア	イ	ウ	エ	オ	カ	キ	ク	ツ
B	ー	ア	イ	ウ	エ	オ	カ	キ	ク	ケ	コ	サ	シ	ス	セ	ソ
C	タ	チ	ツ	テ	ト	ナ	ニ	ヌ	ネ	ノ	ハ	ヒ	フ	ハ	ホ	マ
D	ミ	ム	メ	モ	ヤ	ユ	ヨ	ラ	リ	ル	レ	ロ	ワ	ン	”	”
E	□	■	■	○	●	◇	◆	▶	◀	▲	▼	«	»	¼	½	¾
F	日	月	火	水	木	金	土	年	円	分	人	大	中	小	〒	

n=32h

	0	1	2	3	4	5	6	7	8	9	A	B	C	D	E	F	
8	Œ	Ü	é	â	ä	à	á	Œ	é	ë	è	ï	î	ì	ä	â	
9	É	æ	Æ	ô	ö	ò	ó	ù	ÿ	ö	ü	¢	£	¥	₹	₪	
A	á	í	ó	ú	ñ	ñ	œ	œ	¿	¬	¼	½	¾	¿	»	»	
B	⋮	⋈	⋉		+	+	+	π	π	π	π	π	π	π	π	π	π
C	⊥	⊥	⊥	⊥	⊥	⊥	⊥	⊥	⊥	⊥	⊥	⊥	⊥	⊥	⊥	⊥	⊥
D	ä	ð	é	ë	è	í	í	î	ï	¼	½	¾	¿	»	»	»	
E	ó	β	ô	ò	ö	ø	μ	þ	ð	ó	ó	ù	ÿ	ÿ	ÿ	ÿ	
F	-	±	=	¼	½	¾	÷	∞	°	·	·	1	2	2	■		

n=33h

	0	1	2	3	4	5	6	7	8	9	A	B	C	D	E	F
8	Œ	Ü	é	á	ä	à	Á	Œ	é	è	è	f	ò	i	ä	á
9	É	À	È	ô	ö	ò	Ó	Ò	ï	ö	Ü	ø	£	Ù	Œ	ó
A	á	í	ó	ú	ñ	ñ	œ	œ	¿	ò	¬	¼	¼	i	«	»
B	⋮	⊗	⊗		+	≠	≠	π	π	≠	≠	≠	≠	≠	≠	≠
C	L	⊥	⊥	⊥	-	+	≠	≠	≠	≠	≠	≠	≠	≠	≠	≠
D	≠	≠	π	≠	≠	≠	π	≠	≠	≠	≠	≠	≠	≠	≠	≠
E	α	β	Γ	π	Σ	σ	μ	τ	Φ	Θ	Ω	δ	ω	ψ	ε	Π
F	≡	±	≥	≤	↑	J	÷	∞	°	.	.	√	n	2	■	

n=34h

	0	1	2	3	4	5	6	7	8	9	A	B	C	D	E	F
8	Œ	Ü	é	á	ä	à	Á	Œ	é	ë	è	ï	î	=	À	Σ
9	É	È	È	ô	ë	ï	Ó	Ò	ø	ö	Ü	ø	£	Ù	Ó	f
A	í	´	ó	ú	¨	¸	ø	-	ï	¬	¬	¼	¼	¼	«	»
B	⋮	⊗	⊗		+	≠	≠	π	π	≠	≠	≠	≠	≠	≠	≠
C	L	⊥	⊥	⊥	-	+	≠	≠	≠	≠	≠	≠	≠	≠	≠	≠
D	≠	≠	π	≠	≠	≠	π	≠	≠	≠	≠	≠	≠	≠	≠	≠
E	α	β	Γ	π	Σ	σ	μ	τ	Φ	Θ	Ω	δ	ω	ψ	ε	Π
F	≡	±	≥	≤	↑	J	÷	∞	°	.	.	√	n	2	■	

n=35h

	0	1	2	3	4	5	6	7	8	9	A	B	C	D	E	F
8	Œ	Ü	é	á	ä	à	Á	Œ	é	ë	è	ï	î	i	ä	á
9	É	æ	Æ	ô	ö	ò	Ó	Ò	ÿ	ö	Ü	ø	£	Ø	Œ	f
A	á	í	ó	ú	ñ	ñ	œ	œ	¿	¬	¬	¼	¼	i	«	»
B	⋮	⊗	⊗		+	≠	≠	π	π	≠	≠	≠	≠	≠	≠	≠
C	L	⊥	⊥	⊥	-	+	≠	≠	≠	≠	≠	≠	≠	≠	≠	≠
D	≠	≠	π	≠	≠	≠	π	≠	≠	≠	≠	≠	≠	≠	≠	≠
E	α	β	Γ	π	Σ	σ	μ	τ	Φ	Θ	Ω	δ	ω	ψ	ε	Π
F	≡	±	≥	≤	↑	J	÷	∞	°	.	.	√	n	2	■	

n=36h

	0	1	2	3	4	5	6	7	8	9	A	B	C	D	E	F
8	€		,	f	„	...	†	‡	^	℥	£	<	Ⓔ		ž	
9		‘	’	“	”	•	-	-	~	™	§	>	œ		ž	ÿ
A		ı	¢	£	¤	¥	¦	§	¨	©	ª	«	¬	-	®	¯
B	°	±	²	³	´	µ	¶	·	¸	¹	º	»	¼	½	¾	¿
C	À	Á	Â	Ã	Ä	Å	Æ	Ç	È	É	Ê	Ë	Ì	Í	Î	Ï
D	Ð	Ñ	Ò	Ó	Ô	Õ	Ö	×	Ø	Ù	Ú	Û	Ü	Ý	Þ	ß
E	à	á	â	ã	ä	å	æ	ç	è	é	ê	ë	ì	í	î	ï
F	ð	ñ	ò	ó	ô	õ	ö	÷	ø	ù	ú	û	ü	ý	þ	ÿ

n=37h

	0	1	2	3	4	5	6	7	8	9	A	B	C	D	E	F
8	А	Б	В	Г	Д	Е	Ж	З	И	Й	К	Л	М	Н	О	П
9	Р	С	Т	У	Ф	Х	Ц	Ч	Ш	Щ	Ъ	Ы	Ь	Э	Ю	Я
A	а	б	в	г	д	е	ж	з	и	й	к	л	м	н	о	п
B	Ⓐ	Ⓑ	Ⓒ	Ⓓ	Ⓔ	Ⓕ	Ⓖ	Ⓗ	Ⓘ	Ⓚ	Ⓛ	Ⓜ	Ⓝ	Ⓟ	Ⓠ	Ⓡ
C	Ⓘ	Ⓛ	Ⓜ	Ⓝ	Ⓟ	Ⓠ	Ⓡ	Ⓢ	Ⓣ	Ⓤ	Ⓥ	Ⓦ	Ⓧ	Ⓨ	Ⓩ	ⓐ
D	Ⓢ	Ⓣ	Ⓤ	Ⓥ	Ⓦ	Ⓧ	Ⓨ	Ⓩ	ⓐ	ⓑ	Ⓒ	Ⓓ	Ⓔ	Ⓕ	Ⓖ	Ⓗ
E	р	с	т	у	ф	х	ц	ч	ш	щ	ъ	ы	ь	э	ю	я
F	ё	ё	ё	ё	ï	ï	ÿ	ÿ	°	•	·	√	№	№	■	

n=38h

	0	1	2	3	4	5	6	7	8	9	A	B	C	D	E	F
8	Ÿ	Ü	é	â	ä	û	ś	Ÿ	ı	ë	ö	ö	î	ž	ä	ó
9	é	ı	ı	ô	ö	ı	ı	ś	ś	ö	ü	ı	ı	ı	×	ž
A	á	ı	ó	ú	á	á	ž	ž	Ÿ	Ÿ	¬	ı	ö	ś	«	»
B	Ⓐ	Ⓑ	Ⓒ	Ⓓ	Ⓔ	Ⓕ	Ⓖ	Ⓗ	Ⓘ	Ⓚ	Ⓛ	Ⓜ	Ⓝ	Ⓟ	Ⓠ	Ⓡ
C	Ⓘ	Ⓛ	Ⓜ	Ⓝ	Ⓟ	Ⓠ	Ⓡ	Ⓢ	Ⓣ	Ⓤ	Ⓥ	Ⓦ	Ⓧ	Ⓨ	Ⓩ	ⓐ
D	đ	ð	ð	ë	đ	ñ	ı	ı	ë	ı	ı	■	■	ı	ó	■
E	ó	ß	ö	ñ	ñ	ñ	ś	ś	Ÿ	ú	ı	ü	ÿ	ı	ı	ı
F	-	~	˘	˘	˘	§	÷	˘	°	˘	˘	ü	Ÿ	Ÿ	■	

n=39h

	0	1	2	3	4	5	6	7	8	9	A	B	C	D	E	F
8	Œ	Ü	é	á	ä	à	á	Œ	é	ë	è	ï	î	ì	ä	á
9	É	æ	Æ	ô	ö	ò	ó	ù	ÿ	ö	ü	ø	£	ø	×	f
A	á	í	ó	ú	ñ	ñ	≡	∞	¿	Ø	¬	¼	¾	ì	«	»
B	⋮	⋈	⋉		†	△	△	△	⊗	∥	∥	∩	∪	⊕	≠	∩
C	⊥	⊥	⊥	†	+	⊗	⊗	⊥	⊥	≡	≡	≡	≡	=	≠	≠
D	ä	ð	é	ë	é	é	í	í	í	∟	∟	■	■	ì	ì	■
E	ó	ß	ô	ò	ö	ö	μ	ρ	ρ	ó	ó	ù	ÿ	ÿ	ˉ	˘
F	-	±	=	¼	¾	∞	÷	∫	°	ˆ	˙	1	3	2	■	

6. 保証 WARRANTY

保証期間は弊社出荷後 1 年とする。

This display module is guranteed for 1 year after the shipment from FUTABA.

7. 規制物資等の該非判定及び、輸出する際の注意事項

CAUTIONS FOR DETERMINING AND EXPORTING REGULATED GOODS OR SERVICES

本製品は、技術レベル的には外国為替管理令および輸出貿易管理令の規制上の物資（役務）等に非該当となりますが、他の装置の為に特別に設計した部分品・付属品はその装置の該・非判定により決定されます。

本製品を貴社製装置にご使用頂く弊社製汎用品に付きましては、貴社にて該・非判定をお願いすると共に、汎用品についても兵器等の製造に転用されることのないようご確認をお願い申し上げます。また、その結果、必要に応じた輸出手続等のご処置も併せてお願い申し上げます。

This product does not correspond to the goods or services regulated by Japan's Foreign Exchange and Foreign Trade Law. If this product is combined with other products in order to make equipment, whether this product is regulated or not is judged by such newly made equipment. We ask you to determine by yourself whether the equipment corresponds to the regulated goods when this product is incorporated in the equipment. We also ask you to confirm that this product will not be incorporated in any weapon or used for manufacturing any weapon. If you export or re-export this product, we recommend you to adopt measures for appropriate export procedures, if any

8. 環境対応 ENVIRONMENTALLY CONSCIENTIOUS

本製品は RoHS 適合品です。

This Module complies with RoHS Directive.

8.1 EU RoHS 指令に対して With respect to EU RoHS Directive

含有禁止物質である 6 物質（カドミウム、六価クロム、鉛、水銀、ポリ臭化ビフェニル類（PBB 類）、ポリ臭化ジフェニルエーテル類（PBDE 類））が RoHS 指令に規定される許容値以下、又は、適用除外項目に相当します。

EU RoHS 指令の適用除外については、EU RoHS 指令第4条に準ずるものが対象となります。

The contained amount of six prohibited substances in this product , which are cadmium, hexavalent chromium, lead, mercury, polybrominated biphenyl:PBB and polybrominated diphenyl ether :PBDE, is less than the permitted level stipulated in the EU RoHS Directive, or these substances are not included in the Directive.

The substances excluded are based on Article 4 of the EU RoHS Directive.

8.2 中国RoHS に対して With respect to Chinese RoHS

含有禁止物質である6物質（カドミウム、六価クロム、鉛、水銀、ポリ臭化ビフェニル類（PBB類）、ポリ臭化ジフェニルエーテル類（PBDE類））が中国RoHS指令に規定される許容値以下となります。

The contained amount of six prohibited substances in this product , which are cadmium, hexavalent chromium, lead, mercury, polybrominated biphenyl:PBB and polybrominated diphenyl ether :PBDE, is less than the permitted level stipulated in the Chinese RoHS Directive.

9. 使用上の注意事項 CAUTIONS FOR OPERATION

9-1. モジュールに取り付けられている LCD はガラス製品ですので、規定値以上の振動や衝撃を加えると破損することがあります。

規定値以上の振動や衝撃を加えないように十分注意して取り扱って下さい。

Since LCD is made of glass material, avoid applying excessive shock or vibration beyond the specification for the module. Careful handling is essential.

9-2. 電圧 Vcc の立ち上がりが遅いと正しい動作をしない場合がありますので、30ms 以内に規定電圧に立ち上がる電源が必要です。

If the startup time of the supply voltage is slow, the controller may not be reset.

The supply voltage must be risen up to specified voltage level within 30msec.

9-3. RS232C 仕様の場合、電源投入時約 5 倍のサージ電流が流れることがあります。

USB/Bluetooth 仕様の場合、電源電圧部に 10 μ F 以下の容量があり、電源投入時に突入電流が発生します。

Case of the RS232C type, the surge current can be approx. 5 times the supply current (Max.) at power on.

Case of the USB/Bluetooth type, the capacity of 10 or less is in a power supply circuit of module. Inrush current occurs in power-on.

9-4. ノイズの影響を受けやすい環境下での使用は極力避けて下さい。信号に影響を及ぼし、モジュールの正常動作を妨げる場合があります。

Avoid using the module where excessive noise interface is expected. Noise affects the interface signal and cause improper operation.

9-5. 同一表示パターンで長時間点灯しますと若干の輝度ムラが発生することがあります。美しい表示品位を保つため、同一表示パターンを避けていただくことをお勧めします。

When fixed pattern is displayed for long time, you may see uneven luminance. It is recommended to change the display patterns sometimes in order to keep best display quality.

9-6. 製品は、紫外線により劣化しますので直射日光下または紫外線光の下での長時間の放置は避けてください。

This module deteriorates with ultraviolet ray, so please avoid letting module to be exposed to the sunlight or an ultraviolet ray for a long time.

★お断り★ REMARKS

本仕様の記載内容は特性改善のため、断りなく変更する場合があります。
御使用に際しましては、念のため弊社に御確認下さるようお願い申し上げます。
The specification is subject to change without prior notice.
Your consultation with FUTABA sales office is recommended for the use of this module.

Mouser Electronics

Authorized Distributor

Click to View Pricing, Inventory, Delivery & Lifecycle Information:

Futaba:

[AH148BB](#) [AH148BC](#)