

Test disconnect terminal block - UTME 6

3047400

<https://www.phoenixcontact.com/us/products/3047400>

Please be informed that the data shown in this PDF document is generated from our Online Catalog. Please find the complete data in the user documentation. Our General Terms of Use for Downloads are valid.



Test disconnect terminal block, nom. voltage: 500 V, nominal current: 30 A, 1 level, connection method: Screw connection, Rated cross section: 6 mm², cross section: 0.2 mm² - 10 mm², mounting: NS 35/7,5, NS 35/15, color: gray

Your advantages

- Feed-through terminal blocks of the same shape are available
- Clear
- Clear selection thanks to printed switching symbols
- Easy operation
- Six function shafts
- Compact design
- Flexible and comprehensive accessories
- Reliably snapped into the end positions
- Contact made via screw terminal points

Test disconnect terminal block - UTME 6



3047400

<https://www.phoenixcontact.com/us/products/3047400>

Commercial Data

Item number	3047400
Packing unit	1 pc
Minimum order quantity	1 pc
Sales Key	B01
Product Key	BE1133
Catalog Page	Page 177 (C-1-2019)
GTIN	4046356291101
Weight per Piece (including packing)	29.102 g
Weight per Piece (excluding packing)	28.167 g
Customs tariff number	85369010
Country of origin	PL

Test disconnect terminal block - UTME 6



3047400

<https://www.phoenixcontact.com/us/products/3047400>

Technical Data

Product properties

Product type	Test disconnect terminal block
Number of connections	2
Number of rows	1
Potentials	1

Insulation characteristics

Overvoltage category	III
Degree of pollution	3

Electrical properties

Rated surge voltage	6 kV
Maximum power dissipation for nominal condition	1.31 W

Connection data

Number of connections per level	2
Nominal cross section	6 mm ²

1 level

Screw thread	M4
Tightening torque	1.5 ... 1.8 Nm
Stripping length	10 mm
Internal cylindrical gage	A5
Conductor cross section solid	0.2 mm ² ... 10 mm ²
Cross section AWG	24 ... 8
Conductor cross section flexible	0.2 mm ² ... 10 mm ²
Conductor cross section, flexible [AWG]	24 ... 8
Flexible conductor cross section flexible (ferrule, w/o plastic sleeve)	0.25 mm ² ... 6 mm ²
Flexible conductor cross section (ferrule with plastic sleeve)	0.25 mm ² ... 6 mm ²
2 conductors with same cross section, solid	0.2 mm ² ... 2.5 mm ²
2 conductors with same cross section, flexible	0.2 mm ² ... 2.5 mm ²
2 conductors with same cross section, flexible, with ferrule without plastic sleeve	0.25 mm ² ... 1.5 mm ²
2 conductors with the same cross section, flexible, with TWIN ferrule with plastic sleeve	0.5 mm ² ... 4 mm ²
Nominal current	30 A
Maximum load current	30 A (with 10 mm ² conductor cross section)
Nominal voltage	500 V
Nominal cross section	6 mm ²

Dimensions

Width	8.2 mm
-------	--------

Test disconnect terminal block - UTME 6



3047400

<https://www.phoenixcontact.com/us/products/3047400>

End cover width	2.2 mm
Height NS 35/15	57.1 mm
Height NS 35/7,5	49.6 mm
Length	100.8 mm

Material specifications

Color	gray
Flammability rating according to UL 94	V0
Insulating material group	I
Insulating material	PA
Static insulating material application in cold	-60 °C
Temperature index of insulation material (DIN EN 60216-1 (VDE 0304-21))	130 °C
Relative insulation material temperature index (Elec., UL 746 B)	130 °C
Fire protection for rail vehicles (DIN EN 45545-2) R22	HL 1 - HL 3
Fire protection for rail vehicles (DIN EN 45545-2) R23	HL 1 - HL 3
Fire protection for rail vehicles (DIN EN 45545-2) R24	HL 1 - HL 3
Fire protection for rail vehicles (DIN EN 45545-2) R26	HL 1 - HL 3
Calorimetric heat release NFPA 130 (ASTM E 1354)	28 MJ/kg
Surface flammability NFPA 130 (ASTM E 162)	passed
Specific optical density of smoke NFPA 130 (ASTM E 662)	passed
Smoke gas toxicity NFPA 130 (SMP 800C)	passed

Electrical tests

Surge voltage test

Test voltage setpoint	7.3 kV
Result	Test passed

Temperature-rise test

Requirement temperature-rise test	Increase in temperature \leq 45 K
Result	Test passed
Short-time withstand current 6 mm ²	0.72 kA
Short-time withstand current 4 mm ²	0.5 kA
	0.15 kA
Result	Test passed

Power-frequency withstand voltage

Test voltage setpoint	1.89 kV
Result	Test passed

Mechanical properties

Mechanical data

Open side panel	Yes
-----------------	-----

Mechanical tests

Test disconnect terminal block - UTME 6



3047400

<https://www.phoenixcontact.com/us/products/3047400>

Mechanical strength

Result	Test passed
--------	-------------

Attachment on the carrier

DIN rail/fixing support	NS 35
Test force setpoint	5 N
Result	Test passed

Test for conductor damage and slackening

Rotation speed	10 rpm
Revolutions	135
Conductor cross section/weight	0.2 mm ² / 0.2 kg
	6 mm ² / 1.4 kg
	10 mm ² / 2 kg
Result	Test passed

Environmental and real-life conditions

Needle-flame test

Time of exposure	30 s
Result	Test passed

Oscillation/broadband noise

Specification	DIN EN 50155 (VDE 0115-200):2008-03
Spectrum	Service life test category 2, bogie-mounted
Frequency	$f_1 = 5 \text{ Hz}$ to $f_2 = 250 \text{ Hz}$
ASD level	11.83 (m/s ²) ² /Hz
Acceleration	4.25g
Test duration per axis	5 h
Test directions	X-, Y- and Z-axis
Result	Test passed

Shocks

Specification	DIN EN 50155 (VDE 0115-200):2008-03
Pulse shape	Half-sine
Acceleration	30g
Shock duration	18 ms
Number of shocks per direction	3
Test directions	X-, Y- and Z-axis (pos. and neg.)
Result	Test passed

Ambient conditions

Ambient temperature (operation)	-60 °C ... 105 °C (max. short-term operating temperature RTI Elec.)
Ambient temperature (storage/transport)	-25 °C ... 60 °C (for a short time, not exceeding 24 h, -60 °C to +70 °C)
Ambient temperature (assembly)	-5 °C ... 70 °C

Test disconnect terminal block - UTME 6



3047400

<https://www.phoenixcontact.com/us/products/3047400>

Ambient temperature (actuation)	-5 °C ... 70 °C
Permissible humidity (storage/transport)	30 % ... 70 %

Standards and regulations

Connection in acc. with standard	IEC 60947-7-1
----------------------------------	---------------

Mounting

Mounting type	NS 35/7,5
	NS 35/15

Test disconnect terminal block - UTME 6

3047400

<https://www.phoenixcontact.com/us/products/3047400>

Drawings

Schematic diagram

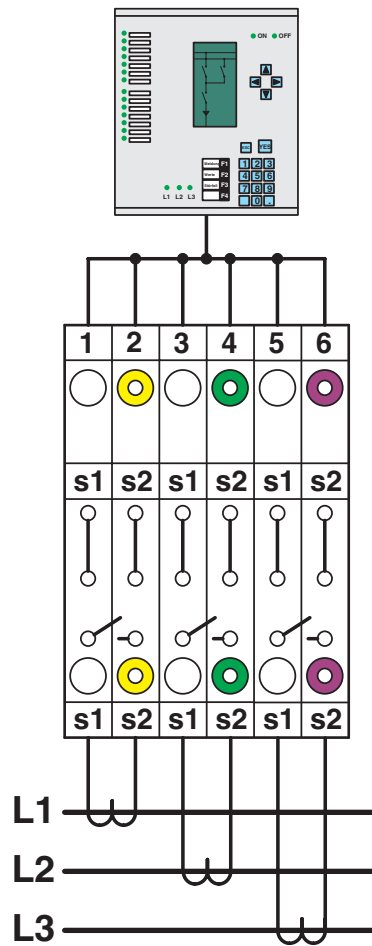

Simple three-phase current transformer set

Test disconnect terminal block - UTME 6



3047400

<https://www.phoenixcontact.com/us/products/3047400>

Circuit diagram

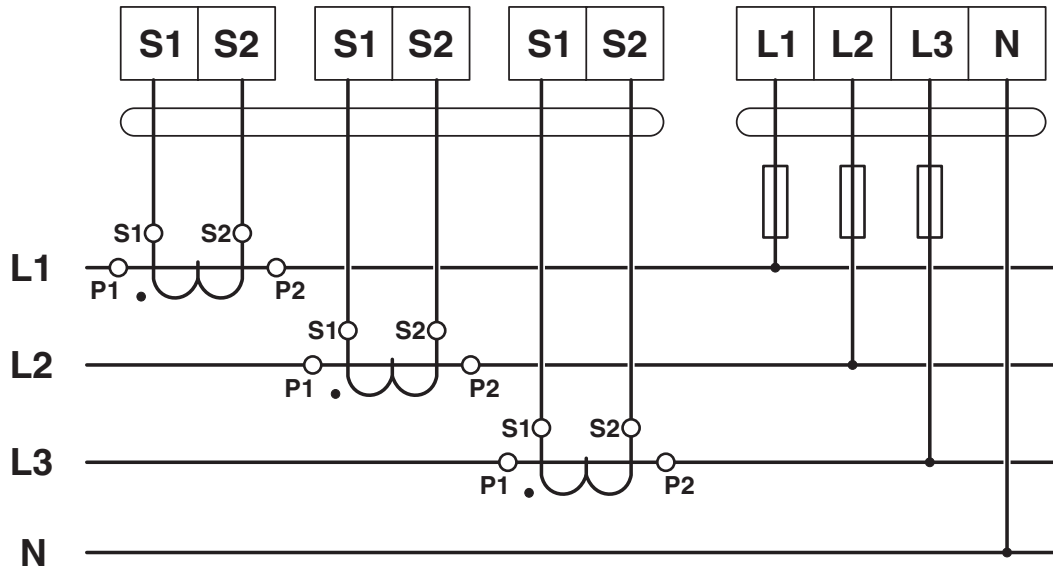

Test disconnect terminal block - UTME 6

3047400

<https://www.phoenixcontact.com/us/products/3047400>

Schematic diagram

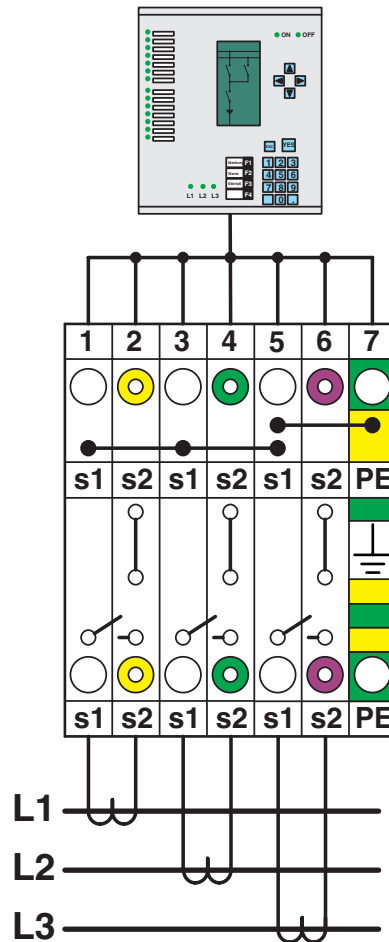

Interlinked three-phase current transformer set with grounded star point

Test disconnect terminal block - UTME 6

3047400

<https://www.phoenixcontact.com/us/products/3047400>

Schematic diagram

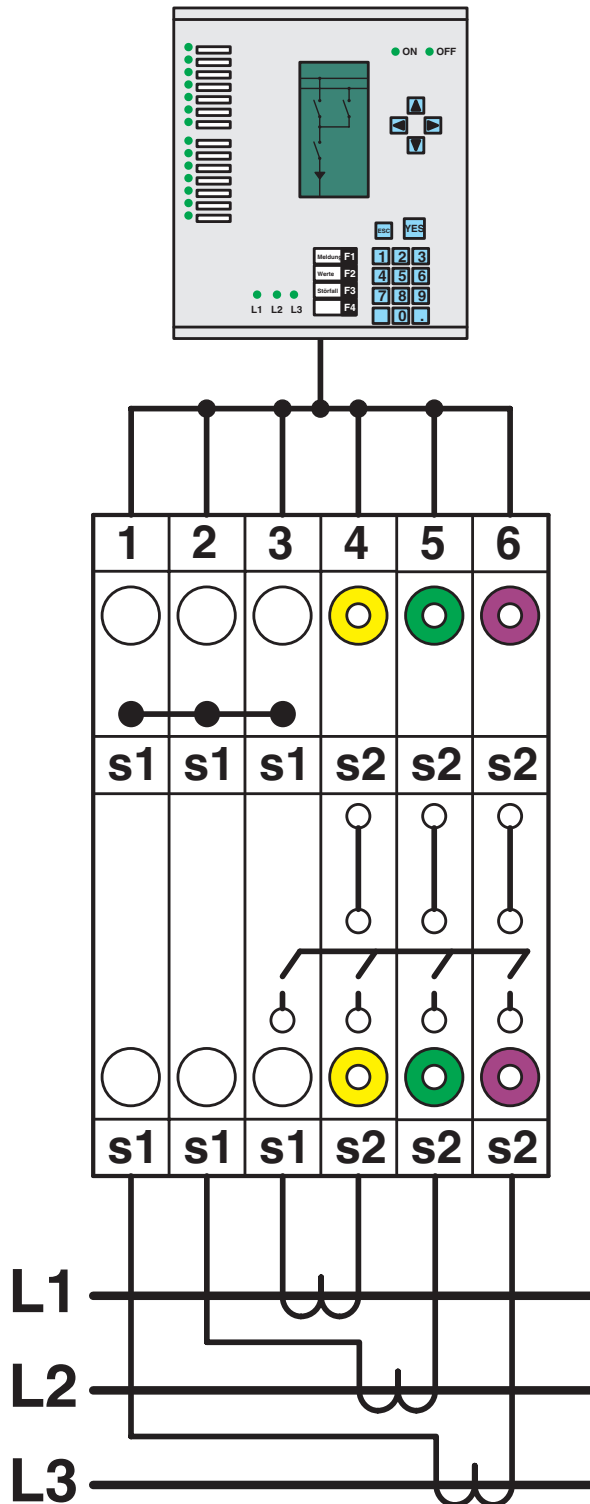

Interlinked three-phase current transformer set

Test disconnect terminal block - UTME 6

3047400

<https://www.phoenixcontact.com/us/products/3047400>

Circuit diagram

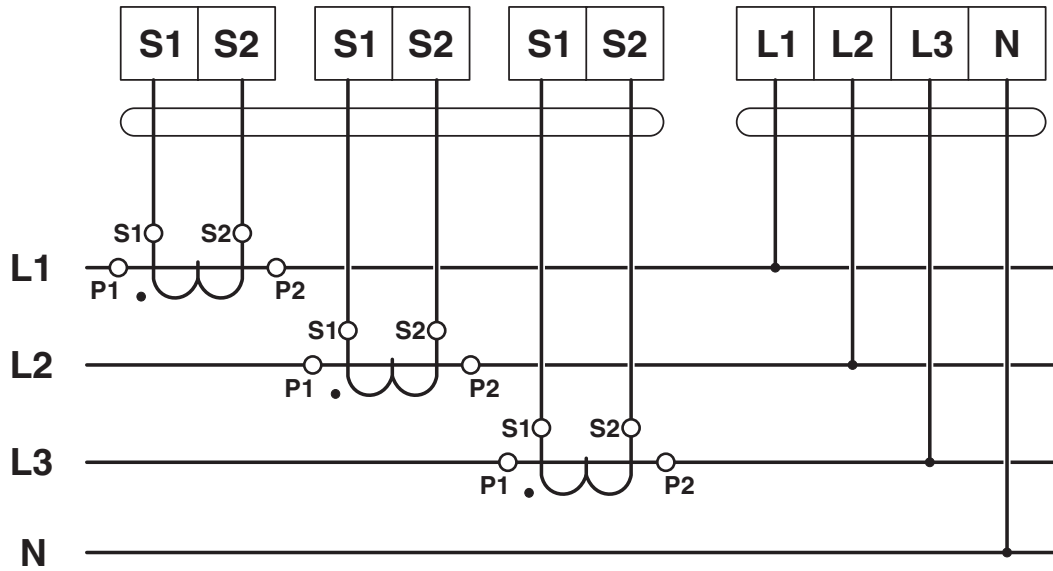

Circuit diagram

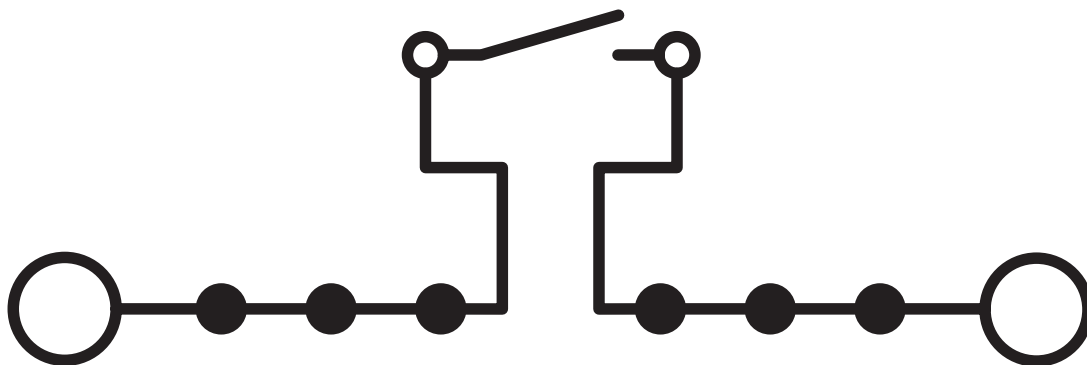

Test disconnect terminal block - UTME 6





3047400

<https://www.phoenixcontact.com/us/products/3047400>

Approvals

 CSA Approval ID: 13631				
	Nominal Voltage U_N	Nominal Current I_N	Cross Section AWG	Cross Section mm^2
Use group B				
	600 V	30 A	24 - 8	-
Use group C				
	600 V	30 A	24 - 8	-

 EAC Approval ID: RU C-DE.AI30.B.01102				
---	--	--	--	--

 cULus Recognized Approval ID: E60425				
	Nominal Voltage U_N	Nominal Current I_N	Cross Section AWG	Cross Section mm^2
Use group B				
	300 V	30 A	24 - 8	-
Multi-conductor connection	300 V	30 A	24 - 12	-
Use group C				
	300 V	30 A	24 - 8	-
Multi-conductor connection	300 V	30 A	24 - 12	-
Use group D				
	600 V	5 A	24 - 8	-
Multi-conductor connection	600 V	5 A	24 - 12	-

 EAC Approval ID: RU C-DE.BL08.B.00534				
---	--	--	--	--

Test disconnect terminal block - UTME 6



3047400

<https://www.phoenixcontact.com/us/products/3047400>

Classifications

ECLASS

ECLASS-9.0	27141126
ECLASS-10.0.1	27141126
ECLASS-11.0	27141126

ETIM

ETIM 8.0	EC000902
----------	----------

UNSPSC

UNSPSC 21.0	39121400
-------------	----------

Test disconnect terminal block - UTME 6



3047400

<https://www.phoenixcontact.com/us/products/3047400>

Environmental Product Compliance

China RoHS	Environmentally friendly use period: unlimited = EFUP-e No hazardous substances above threshold values
------------	---

Test disconnect terminal block - UTME 6

3047400

<https://www.phoenixcontact.com/us/products/3047400>

Accessories

 Note: Applying some accessories below might limit this product.

Plug-in bridge

Plug-in bridge - FBS 2-8 - 3030284

<https://www.phoenixcontact.com/us/products/3030284>



Plug-in bridge, pitch: 8.2 mm, color: red

 Max. current carrying capacity: 30 A

Plug-in bridge

Plug-in bridge - FBS 3-8 - 3030297

<https://www.phoenixcontact.com/us/products/3030297>



Plug-in bridge, pitch: 8.2 mm, color: red

 Max. current carrying capacity: 30 A

Test disconnect terminal block - UTME 6

3047400

<https://www.phoenixcontact.com/us/products/3047400>

Plug-in bridge

Plug-in bridge - FBS 4-8 - 3030307

<https://www.phoenixcontact.com/us/products/3030307>



Plug-in bridge, pitch: 8.2 mm, color: red

 Max. current carrying capacity: 30 A

Plug-in bridge

Plug-in bridge - FBS 5-8 - 3030310

<https://www.phoenixcontact.com/us/products/3030310>



Plug-in bridge, pitch: 8.2 mm, color: red

 Max. current carrying capacity: 30 A

Test disconnect terminal block - UTME 6

3047400

<https://www.phoenixcontact.com/us/products/3047400>

Plug-in bridge

Plug-in bridge - FBS 6-8 - 3032470

<https://www.phoenixcontact.com/us/products/3032470>



Plug-in bridge, pitch: 8.2 mm, color: red

 Max. current carrying capacity: 30 A

Plug-in bridge

Plug-in bridge - FBS 10-8 - 3030323

<https://www.phoenixcontact.com/us/products/3030323>



Plug-in bridge, pitch: 8.2 mm, color: red

 Max. current carrying capacity: 30 A

Test disconnect terminal block - UTME 6

3047400

<https://www.phoenixcontact.com/us/products/3047400>

Plug-in bridge

Plug-in bridge - FBS 1/3-8 - 3032363

<https://www.phoenixcontact.com/us/products/3032363>



Plug-in bridge, pitch: 8.2 mm, pin assignment: 1,3, color: red

 Max. current carrying capacity: 30 A

Plug-in bridge

Plug-in bridge - FBS 1/4-8 - 3032376

<https://www.phoenixcontact.com/us/products/3032376>



Plug-in bridge, pitch: 8.2 mm, pin assignment: 1, 4, color: red

 Max. current carrying capacity: 30 A

Test disconnect terminal block - UTME 6

3047400

<https://www.phoenixcontact.com/us/products/3047400>

Plug-in bridge

Plug-in bridge - FBS 1/5-8 - 3032381

<https://www.phoenixcontact.com/us/products/3032381>



Plug-in bridge, pitch: 8.2 mm, pin assignment: 1,5, color: red

 Max. current carrying capacity: 30 A

Plug-in bridge

Plug-in bridge - FBS 1/3/5-8 - 3032389

<https://www.phoenixcontact.com/us/products/3032389>



Plug-in bridge, pitch: 8.2 mm, pin assignment: 1,3,5, color: red

 Max. current carrying capacity: 30 A

Test disconnect terminal block - UTME 6

3047400

<https://www.phoenixcontact.com/us/products/3047400>

Plug-in bridge

Plug-in bridge - FBS 1/4/7/10-8 - 3032402

<https://www.phoenixcontact.com/us/products/3032402>

Plug-in bridge, pitch: 8.2 mm, pin assignment: 1,4,7,10, color: red



 Max. current carrying capacity: 30 A

Short-circuit connector

Short-circuit connector - FBSRH 2-8 - 3033802

<https://www.phoenixcontact.com/us/products/3033802>

Short-circuit connector, pitch: 8.2 mm, color: red



 Max. current carrying capacity: 30 A

Test disconnect terminal block - UTME 6

3047400

<https://www.phoenixcontact.com/us/products/3047400>

Short-circuit connector

Short-circuit connector - FBSRH 3-8 - 3033803

<https://www.phoenixcontact.com/us/products/3033803>



Short-circuit connector, pitch: 8.2 mm, color: red

 Max. current carrying capacity: 30 A

Short-circuit connector

Short-circuit connector - FBSRH 4-8 - 3033804

<https://www.phoenixcontact.com/us/products/3033804>



Short-circuit connector, pitch: 8.2 mm, color: red

 Max. current carrying capacity: 30 A

Test disconnect terminal block - UTME 6

3047400

<https://www.phoenixcontact.com/us/products/3047400>

Plug-in bridge

Plug-in bridge - FBSR 2-8 - 3033808

<https://www.phoenixcontact.com/us/products/3033808>



Plug-in bridge, pitch: 8.2 mm, color: red

 Max. current carrying capacity: 30 A

Plug-in bridge

Plug-in bridge - FBSR 3-8 - 3001597

<https://www.phoenixcontact.com/us/products/3001597>



Plug-in bridge, pitch: 8.2 mm, color: red

 Max. current carrying capacity: 30 A

Test disconnect terminal block - UTME 6

3047400

<https://www.phoenixcontact.com/us/products/3047400>

Plug-in bridge

Plug-in bridge - FBSR 4-8 - 3000585

<https://www.phoenixcontact.com/us/products/3000585>



Plug-in bridge, pitch: 8.2 mm, color: red

 Max. current carrying capacity: 30 A

Plug-in bridge

Plug-in bridge - FBSR 5-8 - 3033809

<https://www.phoenixcontact.com/us/products/3033809>



Plug-in bridge, pitch: 8.2 mm, color: red

 Max. current carrying capacity: 30 A

Test disconnect terminal block - UTME 6

3047400

<https://www.phoenixcontact.com/us/products/3047400>

Plug-in bridge

Plug-in bridge - FBSR 10-8 - 3001599

<https://www.phoenixcontact.com/us/products/3001599>



Plug-in bridge, pitch: 8.2 mm, color: red

 Max. current carrying capacity: 30 A

Plug-in bridge

Plug-in bridge - FBSR 16-8 - 3033816

<https://www.phoenixcontact.com/us/products/3033816>

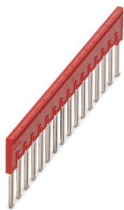

Plug-in bridge, pitch: 8.2 mm, color: red

 Max. current carrying capacity: 30 A

Test disconnect terminal block - UTME 6

3047400

<https://www.phoenixcontact.com/us/products/3047400>

Plug-in bridge

Plug-in bridge - FBSR 1/6/11/14-8 - 3033822

<https://www.phoenixcontact.com/us/products/3033822>



Plug-in bridge, non-adjacent, pitch: 8.2 mm, pin assignment: 1, 6, 11, 14, color: red

 Max. current carrying capacity: 30 A

Plug-in bridge

Plug-in bridge - FBSR 1/6/11/16-8 - 3033820

<https://www.phoenixcontact.com/us/products/3033820>



Plug-in bridge, non-adjacent, pitch: 8.2 mm, pin assignment: 1, 6, 11, 16, color: red

 Max. current carrying capacity: 30 A

Test disconnect terminal block - UTME 6

3047400

<https://www.phoenixcontact.com/us/products/3047400>

Plug-in bridge

Plug-in bridge - FBSR 1/7/13/16-8 - 3033821

<https://www.phoenixcontact.com/us/products/3033821>



Plug-in bridge, non-adjacent, pitch: 8.2 mm, pin assignment: 1, 7, 13, 16, color: red

 Max. current carrying capacity: 30 A

Switching jumper

Switching jumper - SB-ME 2-8 - 3034468

<https://www.phoenixcontact.com/us/products/3034468>



Switching jumper, pitch: 8.2 mm, color: gray/orange

 Max. current carrying capacity: 30 A

Test disconnect terminal block - UTME 6

3047400

<https://www.phoenixcontact.com/us/products/3047400>



Switching jumper

Switching jumper - SB-ME 3-8 - 3032800

<https://www.phoenixcontact.com/us/products/3032800>



Switching jumper, pitch: 8.2 mm, color: gray/orange

 Max. current carrying capacity: 30 A

Switching jumper

Switching jumper - SB-ME 4-8 - 3034484

<https://www.phoenixcontact.com/us/products/3034484>



Switching jumper, pitch: 8.2 mm, color: gray/orange

 Max. current carrying capacity: 30 A

Test disconnect terminal block - UTME 6

3047400

<https://www.phoenixcontact.com/us/products/3047400>



Switching jumper

Switching jumper - SB-MER 2-8 - 3000587

<https://www.phoenixcontact.com/us/products/3000587>



Switching jumper, pitch: 8.2 mm, color: gray/orange

 Max. current carrying capacity: 25 A

Switching jumper

Switching jumper - SB-MER 3-8 - 3000588

<https://www.phoenixcontact.com/us/products/3000588>



Switching jumper, pitch: 8.2 mm, color: gray/orange

 Max. current carrying capacity: 25 A

Test disconnect terminal block - UTME 6

3047400

<https://www.phoenixcontact.com/us/products/3047400>

Switching jumper

Switching jumper - SB-MER 4-8 - 3000589

<https://www.phoenixcontact.com/us/products/3000589>



Switching jumper, pitch: 8.2 mm, color: gray/orange

 Max. current carrying capacity: 25 A

Plug-in bridge

Plug-in bridge - FBS 2-8 CT - 3033830

<https://www.phoenixcontact.com/us/products/3033830>



Plug-in bridge, pitch: 8.2 mm, color: orange

 Max. current carrying capacity: 30 A

Test disconnect terminal block - UTME 6

3047400

<https://www.phoenixcontact.com/us/products/3047400>

Plug-in bridge

Plug-in bridge - FBS 3-8 CT - 3033831

<https://www.phoenixcontact.com/us/products/3033831>



Plug-in bridge, pitch: 8.2 mm, color: orange

 Max. current carrying capacity: 30 A

Plug-in bridge

Plug-in bridge - FBS 4-8 CT - 3033832

<https://www.phoenixcontact.com/us/products/3033832>



Plug-in bridge, pitch: 8.2 mm, color: orange

 Max. current carrying capacity: 30 A

Test disconnect terminal block - UTME 6

3047400

<https://www.phoenixcontact.com/us/products/3047400>

Plug-in bridge

Plug-in bridge - FBS 10-8 CT - 3033833

<https://www.phoenixcontact.com/us/products/3033833>



Plug-in bridge, pitch: 8.2 mm, color: orange

 Max. current carrying capacity: 30 A

Plug-in bridge

Plug-in bridge - FBS 2-8 BU - 3032567

<https://www.phoenixcontact.com/us/products/3032567>



Plug-in bridge, pitch: 8.2 mm, color: blue

 Max. current carrying capacity: 30 A

Test disconnect terminal block - UTME 6

3047400

<https://www.phoenixcontact.com/us/products/3047400>

Plug-in bridge

Plug-in bridge - FBS 3-8 BU - 3032570

<https://www.phoenixcontact.com/us/products/3032570>



Plug-in bridge, pitch: 8.2 mm, color: blue

 Max. current carrying capacity: 30 A

Plug-in bridge

Plug-in bridge - FBS 4-8 BU - 3032583

<https://www.phoenixcontact.com/us/products/3032583>



Plug-in bridge, pitch: 8.2 mm, color: blue

 Max. current carrying capacity: 30 A

Test disconnect terminal block - UTME 6

3047400

<https://www.phoenixcontact.com/us/products/3047400>

Plug-in bridge

Plug-in bridge - FBS 5-8 BU - 3032596

<https://www.phoenixcontact.com/us/products/3032596>

Plug-in bridge, pitch: 8.2 mm, color: blue



 Max. current carrying capacity: 30 A

Plug-in bridge

Plug-in bridge - FBS 6-8 BU - 3032677

<https://www.phoenixcontact.com/us/products/3032677>

Plug-in bridge, pitch: 8.2 mm, color: blue



 Max. current carrying capacity: 30 A

Test disconnect terminal block - UTME 6

3047400

<https://www.phoenixcontact.com/us/products/3047400>



Plug-in bridge

Plug-in bridge - FBS 10-8 BU - 3032606

<https://www.phoenixcontact.com/us/products/3032606>

Plug-in bridge, pitch: 8.2 mm, color: blue



 Max. current carrying capacity: 30 A

Screwdriver

Screwdriver - SZS 1,0X4,0 VDE - 1205066

<https://www.phoenixcontact.com/us/products/1205066>

Screwdriver, slot-headed, VDE insulated, size: 1.0 x 4.0 x 100 mm, 2-component grip, with non-slip grip



Test disconnect terminal block - UTME 6

3047400

<https://www.phoenixcontact.com/us/products/3047400>

DIN rail perforated

DIN rail perforated - NS 35/ 7,5 PERF 2000MM - 0801733

<https://www.phoenixcontact.com/us/products/0801733>



DIN rail perforated, acc. to EN 60715, material: Steel, galvanized, passivated with a thick layer, Standard profile, color: silver, Pack of 25 (50 m)

End cover

End cover - D-UTME 6 - 3047426

<https://www.phoenixcontact.com/us/products/3047426>



End cover, length: 100.8 mm, width: 2.2 mm, height: 49.6 mm, color: gray

Test disconnect terminal block - UTME 6

3047400

<https://www.phoenixcontact.com/us/products/3047400>

DIN rail, unperforated

DIN rail, unperforated - NS 35/ 7,5 UNPERF 2000MM - 0801681

<https://www.phoenixcontact.com/us/products/0801681>



DIN rail, unperforated, acc. to EN 60715, material: Steel, galvanized, passivated with a thick layer, Standard profile, color: silver, Pack of 25 (50 m)

Operating lever

Operating lever - C-ME 6/1 - 3034441

<https://www.phoenixcontact.com/us/products/3034441>



Operating lever, for switching test disconnect terminal blocks on and off

Test disconnect terminal block - UTME 6

3047400

<https://www.phoenixcontact.com/us/products/3047400>

DIN rail perforated

DIN rail perforated - NS 35/ 7,5 WH PERF 2000MM - 1204119

<https://www.phoenixcontact.com/us/products/1204119>



DIN rail perforated, acc. to EN 60715, material: Steel, Galvanized, white passivated, Standard profile, color: silver, Pack of 25 (50 m)

Operating lever

Operating lever - C-ME 6/2 - 3034442

<https://www.phoenixcontact.com/us/products/3034442>



Operating lever, length: 5 mm, width: 16 mm, height: 5 mm, number of positions: 2, color: orange

Test disconnect terminal block - UTME 6

3047400

<https://www.phoenixcontact.com/us/products/3047400>

DIN rail, unperforated

DIN rail, unperforated - NS 35/ 7,5 WH UNPERF 2000MM-VPE 10 - 1204122

<https://www.phoenixcontact.com/us/products/1204122>



DIN rail, unperforated, acc. to EN 60715, material: Steel, Galvanized, white passivated, Standard profile, color: silver, Pack of 10 (20 m)

Switching lock

Switching lock - S-ME 6 - 3034439

<https://www.phoenixcontact.com/us/products/3034439>



Switching lock, length: 12 mm, width: 8.2 mm, color: white

Test disconnect terminal block - UTME 6

3047400

<https://www.phoenixcontact.com/us/products/3047400>

DIN rail, unperforated

DIN rail, unperforated - NS 35/ 7,5 AL UNPERF 2000MM - 0801704

<https://www.phoenixcontact.com/us/products/0801704>



DIN rail, unperforated, acc. to EN 60715, material: Aluminum, uncoated, Standard profile, color: silver, Pack of 25 (50 m)

Partition plate

Partition plate - CARRIER 35-8 - 3034387

<https://www.phoenixcontact.com/us/products/3034387>



Partition plate, material: PA, color: gray, With storage option for FBS...-8 and PAI 4-FIX

Test disconnect terminal block - UTME 6

3047400

<https://www.phoenixcontact.com/us/products/3047400>

DIN rail perforated

DIN rail perforated - NS 35/ 7,5 ZN PERF 2000MM - 1206421

<https://www.phoenixcontact.com/us/products/1206421>



DIN rail perforated, acc. to EN 60715, material: Steel, galvanized, Standard profile, color: silver, Pack of 25 (50 m)

Cover profile

Cover profile - AP-ME METER - 3034361

<https://www.phoenixcontact.com/us/products/3034361>



Cover profile, for covering terminal strips, snapped onto APT-ME cover profile carrier or APH-ME end bracket. A cover profile carrier should be positioned at the ends and at intervals of around 40 cm. Length supplied: 1 m

Test disconnect terminal block - UTME 6

3047400

<https://www.phoenixcontact.com/us/products/3047400>

DIN rail, unperforated

DIN rail, unperforated - NS 35/ 7,5 ZN UNPERF 2000MM - 1206434

<https://www.phoenixcontact.com/us/products/1206434>



DIN rail, unperforated, acc. to EN 60715, material: Steel, galvanized, Standard profile, color: silver, Pack of 25 (50 m)

Cover profile carrier

Cover profile carrier - APH-ME - 3034374

<https://www.phoenixcontact.com/us/products/3034374>

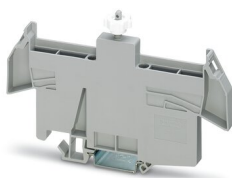

Cover profile carrier, for mounting on NS 35/7,5 DIN rail, for fixing the AP-ME cover profile, can be sealed as an option

Test disconnect terminal block - UTME 6

3047400

<https://www.phoenixcontact.com/us/products/3047400>

DIN rail, unperforated

DIN rail, unperforated - NS 35/ 7,5 CU UNPERF 2000MM-VPE 10 - 0801762

<https://www.phoenixcontact.com/us/products/0801762>



DIN rail, unperforated, acc. to EN 60715, material: Copper, uncoated, Standard profile, color: copper-colored, Pack of 10 (20 m)

Cover profile carrier

Cover profile carrier - APT-ME - 3034358

<https://www.phoenixcontact.com/us/products/3034358>



Cover profile carrier for mounting on NS 35/7.5 DIN rail for attaching the cover profile AP-ME

Test disconnect terminal block - UTME 6

3047400

<https://www.phoenixcontact.com/us/products/3047400>

End cap

End cap - NS 35/ 7,5 CAP - 1206560

<https://www.phoenixcontact.com/us/products/1206560>

DIN rail end piece, for DIN rail NS 35/7.5



Operating lever

Operating lever - C-ME 6/3 - 3034390

<https://www.phoenixcontact.com/us/products/3034390>

Operating lever, length: 5 mm, width: 24.1 mm, height: 5 mm, number of positions: 3, color: orange



Test disconnect terminal block - UTME 6

3047400

<https://www.phoenixcontact.com/us/products/3047400>

Test adapter

Test adapter - PAI-4-FIX BU - 3032729

<https://www.phoenixcontact.com/us/products/3032729>



Test adapter, Touch proof against unintentional direct contact according to DIN EN 50274 when plugged in, for 4 mm test plug and terminal blocks with 8.2 mm pitch, color: blue

Covering hood

Covering hood - AH-ME - 3240265

<https://www.phoenixcontact.com/us/products/3240265>



Cover, for the contact- and dust-protected encapsulation of the components

Test disconnect terminal block - UTME 6

3047400

<https://www.phoenixcontact.com/us/products/3047400>

Test adapter

Test adapter - PAI-4-FIX OG - 3034455

<https://www.phoenixcontact.com/us/products/3034455>



4 mm test adapter, for terminal blocks with 8.2 mm pitch

Switching lock

Switching lock - SL-SB - 3035761

<https://www.phoenixcontact.com/us/products/3035761>



Switching lock, for additional locking of short-circuit switching elements in current transformer measuring circuits, length: 16.3 mm, width: 12.5 mm, height: 13.6 mm, color: white

Test disconnect terminal block - UTME 6

3047400

<https://www.phoenixcontact.com/us/products/3047400>

Test adapter

Test adapter - PAI-4-FIX YE - 3032745

<https://www.phoenixcontact.com/us/products/3032745>



Test adapter, Touch proof against unintentional direct contact according to DIN EN 50274 when plugged in, for 4 mm test plug and terminal blocks with 8.2 mm pitch, color: yellow

Separating plate

Separating plate - TS-UT 6-T/SP - 3072821

<https://www.phoenixcontact.com/us/products/3072821>

Separating plate, length: 105.2 mm, width: 1 mm, height: 67.5 mm, color: gray



Test disconnect terminal block - UTME 6

3047400

<https://www.phoenixcontact.com/us/products/3047400>

Test adapter

Test adapter - PAI-4-FIX RD - 3032732

<https://www.phoenixcontact.com/us/products/3032732>



Test adapter, Touch proof against unintentional direct contact according to DIN EN 50274 when plugged in, for 4 mm test plug and terminal blocks with 8.2 mm pitch, color: red

Test adapter

Test adapter - PAI-4-FIX GN - 3032758

<https://www.phoenixcontact.com/us/products/3032758>



Test adapter, Touch proof against unintentional direct contact according to DIN EN 50274 when plugged in, for 4 mm test plug and terminal blocks with 8.2 mm pitch, color: green

Test disconnect terminal block - UTME 6

3047400

<https://www.phoenixcontact.com/us/products/3047400>

Test adapter

Test adapter - PAI-4-FIX BK - 3032774

<https://www.phoenixcontact.com/us/products/3032774>



Test adapter, Touch proof against unintentional direct contact according to DIN EN 50274 when plugged in, for 4 mm test plug and terminal blocks with 8.2 mm pitch, color: black

Test adapter

Test adapter - PAI-4-FIX GY - 3032790

<https://www.phoenixcontact.com/us/products/3032790>



Test adapter, Touch proof against unintentional direct contact according to DIN EN 50274 when plugged in, for 4 mm test plug and terminal blocks with 8.2 mm pitch, color: gray

Test disconnect terminal block - UTME 6

3047400

<https://www.phoenixcontact.com/us/products/3047400>

Test adapter

Test adapter - PAI-4-FIX VT - 3032761

<https://www.phoenixcontact.com/us/products/3032761>



Test adapter, Touch proof against unintentional direct contact according to DIN EN 50274 when plugged in, for 4 mm test plug and terminal blocks with 4.2 mm .. 8.2 mm pitch, color: violet

Test adapter

Test adapter - PAI-4-FIX BN - 3032787

<https://www.phoenixcontact.com/us/products/3032787>



Test adapter, Touch proof against unintentional direct contact according to DIN EN 50274 when plugged in, for 4 mm test plug and terminal blocks with 8.2 mm pitch, color: brown

Test disconnect terminal block - UTME 6

3047400

<https://www.phoenixcontact.com/us/products/3047400>

Test adapter

Test adapter - PAI-4-FIX WH - 3032797

<https://www.phoenixcontact.com/us/products/3032797>



4 mm test adapter, for terminal blocks with 8.2 mm pitch

Test adapter

Test adapter - PAIS-4-FIX GY - 3032791

<https://www.phoenixcontact.com/us/products/3032791>



Test adapter, Touch proof against unintentional direct contact according to DIN EN 50274 when plugged in, for 4 mm test plug and terminal blocks with 5.2 mm, 6.2 mm, and 8.2 mm pitch, color: gray

Test disconnect terminal block - UTME 6

3047400

<https://www.phoenixcontact.com/us/products/3047400>

Test adapter

Test adapter - PAIS-4-FIX BK - 3032792

<https://www.phoenixcontact.com/us/products/3032792>



Test adapter, Touch proof against unintentional direct contact according to DIN EN 50274 when plugged in, for 4 mm test plug and terminal blocks with 5.2 mm, 6.2 mm, and 8.2 mm pitch, color: black

Test adapter

Test adapter - PAIS-4-FIX RD - 3032793

<https://www.phoenixcontact.com/us/products/3032793>



Test adapter, Do not plug in while the power is connected, for 4 mm test plug and terminal blocks with 5.2 mm, 6.2 mm, and 8.2 mm pitch, color: red

Test disconnect terminal block - UTME 6

3047400

<https://www.phoenixcontact.com/us/products/3047400>

Test adapter

Test adapter - PAIS-4-FIX BU - 3032798

<https://www.phoenixcontact.com/us/products/3032798>



Test adapter, Touch proof against unintentional direct contact according to DIN EN 50274 when plugged in, for 4 mm test plug and terminal blocks with 5.2 mm, 6.2 mm, and 8.2 mm pitch, color: blue

Test adapter

Test adapter - PAIS-4-FIX YE - 3032799

<https://www.phoenixcontact.com/us/products/3032799>



Test adapter, Touch proof against unintentional direct contact according to DIN EN 50274 when plugged in, for 4 mm test plug and terminal blocks with 5.2 mm, 6.2 mm, and 8.2 mm pitch, color: yellow

Test disconnect terminal block - UTME 6

3047400

<https://www.phoenixcontact.com/us/products/3047400>

Test adapter

Test adapter - PAIS-4-FIX GN - 3032801

<https://www.phoenixcontact.com/us/products/3032801>



Test adapter, Touch proof against unintentional direct contact according to DIN EN 50274 when plugged in, for 4 mm test plug and terminal blocks with 5.2 mm, 6.2 mm, and 8.2 mm pitch, color: green

Test adapter

Test adapter - PAIS-4-FIX VT - 3032802

<https://www.phoenixcontact.com/us/products/3032802>



Test adapter, Touch proof against unintentional direct contact according to DIN EN 50274 when plugged in, for 4 mm test plug and terminal blocks with 5.2 mm, 6.2 mm, and 8.2 mm pitch, color: violet

Test disconnect terminal block - UTME 6

3047400

<https://www.phoenixcontact.com/us/products/3047400>

Test plugs

Test plugs - PS-8 - 3031005

<https://www.phoenixcontact.com/us/products/3031005>



Test plugs, Modular test plug, color: red

Spacer plate

Spacer plate - DP PS-8 - 3036741

<https://www.phoenixcontact.com/us/products/3036741>



Spacer plate, length: 22.4 mm, width: 8.2 mm, height: 29 mm, number of positions: 1, color: red

Test disconnect terminal block - UTME 6

3047400

<https://www.phoenixcontact.com/us/products/3047400>

Test plugs

Test plugs - PS-8/2,3MM RD - 3048564

<https://www.phoenixcontact.com/us/products/3048564>



Test plugs, color: red

Zack marker strip

Zack marker strip - ZB 8:UNBEDRUCKT - 1052002

<https://www.phoenixcontact.com/us/products/1052002>

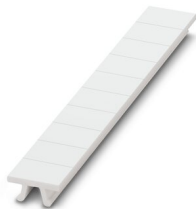

Zack marker strip, Strip, white, unlabeled, can be labeled with: CMS-P1-PLOTTER, PLOTMARK, mounting type: snapped, for terminal block width: 8.2 mm, lettering field size: 10.5 x 8.15 mm, Number of individual labels: 10

Test disconnect terminal block - UTME 6

3047400

<https://www.phoenixcontact.com/us/products/3047400>

Zack marker strip

Zack marker strip - ZB 8 CUS - 0825011

<https://www.phoenixcontact.com/us/products/0825011>



Zack marker strip, can be ordered: Strip, white, labeled according to customer specifications, mounting type: snap into tall marker groove, for terminal block width: 8.2 mm, lettering field size: 10.5 x 8.15 mm, Number of individual labels: 10

Marker for terminal blocks

Marker for terminal blocks - UC-TM 8 - 0818072

<https://www.phoenixcontact.com/us/products/0818072>



Marker for terminal blocks, Sheet, white, unlabeled, can be labeled with: BLUEMARK ID COLOR, BLUEMARK ID, BLUEMARK CLED, PLOTMARK, CMS-P1-PLOTTER, mounting type: snapped, for terminal block width: 8.2 mm, lettering field size: 7.6 x 10.5 mm, Number of individual labels: 56

Test disconnect terminal block - UTME 6

3047400

<https://www.phoenixcontact.com/us/products/3047400>

Marker for terminal blocks

Marker for terminal blocks - UC-TM 8 CUS - 0824597

<https://www.phoenixcontact.com/us/products/0824597>



Marker for terminal blocks, can be ordered: by sheet, white, labeled according to customer specifications, mounting type: snap into tall marker groove, for terminal block width: 8.2 mm, lettering field size: 7.6 x 10.5 mm, Number of individual labels: 56

Marker for terminal blocks

Marker for terminal blocks - UCT-TM 8 - 0828740

<https://www.phoenixcontact.com/us/products/0828740>



Marker for terminal blocks, Sheet, white, unlabeled, can be labeled with: TOPMARK NEO, TOPMARK LASER, BLUEMARK ID COLOR, BLUEMARK ID, BLUEMARK CLED, THERMOMARK PRIME, THERMOMARK CARD 2.0, THERMOMARK CARD, mounting type: snapped, for terminal block width: 8.2 mm, lettering field size: 7.6 x 10.5 mm, Number of individual labels: 42

Test disconnect terminal block - UTME 6

3047400

<https://www.phoenixcontact.com/us/products/3047400>

Marker for terminal blocks

Marker for terminal blocks - UCT-TM 8 CUS - 0829616

<https://www.phoenixcontact.com/us/products/0829616>



Marker for terminal blocks, can be ordered: by sheet, white, labeled according to customer specifications, mounting type: snap into tall marker groove, for terminal block width: 8.2 mm, lettering field size: 7.6 x 10.5 mm, Number of individual labels: 42

Zack marker strip

Zack marker strip - ZB 8,LGS:FORTL.ZAHLEN - 1052015

<https://www.phoenixcontact.com/us/products/1052015>

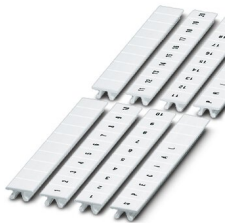

Zack marker strip, Strip, white, labeled, can be labeled with: CMS-P1-PLOTTER, printed horizontally: consecutive numbers 1 ... 10, 11 ... 20, etc. up to 91 ... 100, mounting type: snapped, for terminal block width: 8.2 mm, lettering field size: 10.5 x 8.15 mm, Number of individual labels: 10

Test disconnect terminal block - UTME 6

3047400

<https://www.phoenixcontact.com/us/products/3047400>

Zack marker strip

Zack marker strip - ZB 8,QR:FORTL.ZAHLEN - 1052028

<https://www.phoenixcontact.com/us/products/1052028>



Zack marker strip, Strip, white, labeled, can be labeled with: CMS-P1-PLOTTER, Printed vertically: consecutive numbers 1 ... 10, 11 ... 20, etc. up to 91 ... 100, mounting type: snapped, for terminal block width: 8.2 mm, lettering field size: 10.5 x 8.15 mm, Number of individual labels: 10

Marker for terminal blocks

Marker for terminal blocks - ZB 8,LGS:L1-N,PE - 1052413

<https://www.phoenixcontact.com/us/products/1052413>

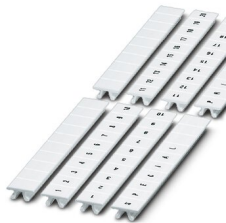

Marker for terminal blocks, Strip, white, labeled, can be labeled with: CMS-P1-PLOTTER, horizontal: L1, L2, L3, N, PE, L1, L2, L3, N, PE, mounting type: snapped, for terminal block width: 8.2 mm, lettering field size: 10.5 x 8.15 mm, Number of individual labels: 10

Test disconnect terminal block - UTME 6



3047400

<https://www.phoenixcontact.com/us/products/3047400>

End clamp

End clamp - E/AL-NS 35 - 1201662

<https://www.phoenixcontact.com/us/products/1201662>



End clamp, for end support of UKH 50 to UKH 240, is pushed onto DIN rail NS 35 and fixed with 2 screws, width: 10 mm, color: aluminum

Phoenix Contact 2022 © - all rights reserved

<https://www.phoenixcontact.com>

Phoenix Contact USA
586 Fulling Mill Road
Middletown, PA 17057, United States
(+717) 944-1300
info@phoenixcon.com