

Data sheet | Item number: 280-684

3-conductor through terminal block; 2.5 mm²; suitable for Ex i applications; center marking; for DIN-rail 35 x 15 and 35 x 7.5; CAGE CLAMP®; 2,50 mm²; blue

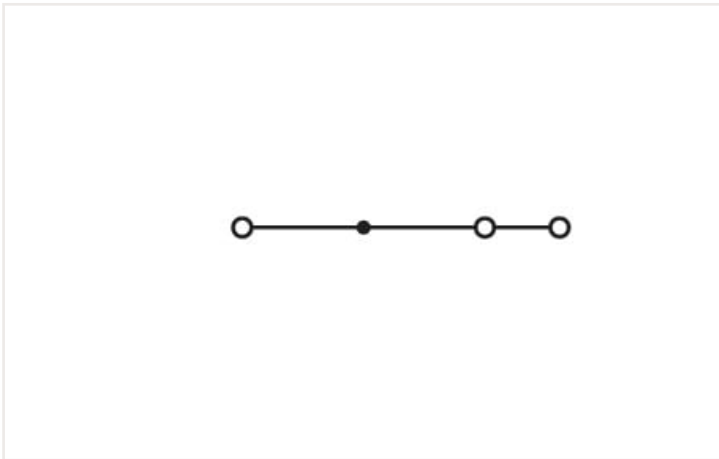

<https://www.wago.com/280-684>

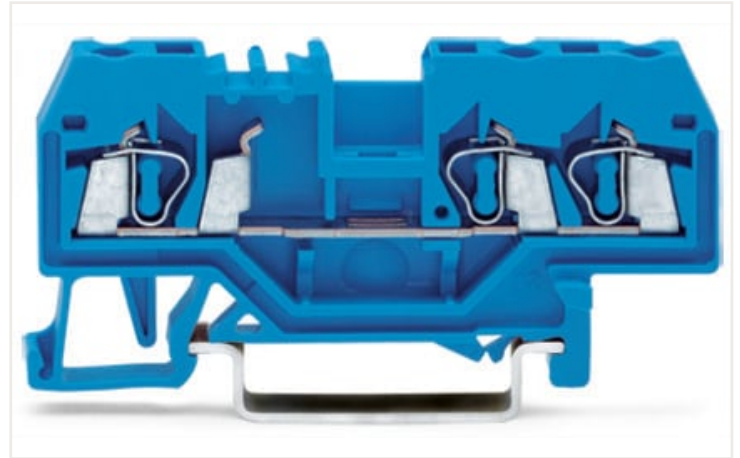
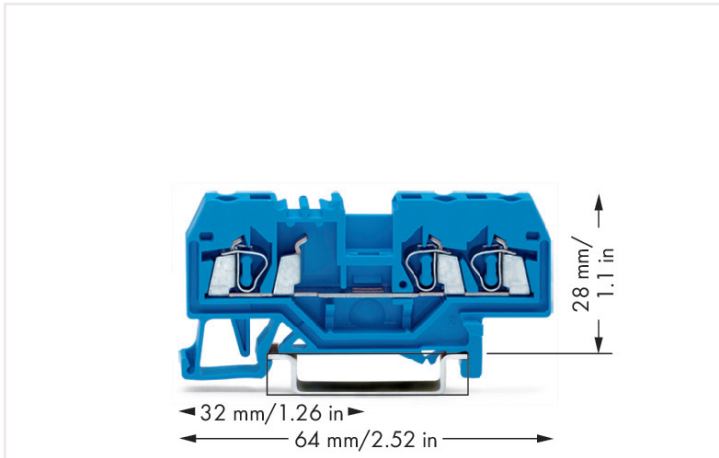

Electrical data

Ratings per IEC/EN

Ratings per	IEC/EN 60947-7-1
Nominal voltage (III/3)	800 V
Rated impulse voltage (III/3)	8 kV
Rated current	24 A
Legend (ratings)	(III / 3) ≙ Overvoltage category III / Pollution degree 3

Ratings per UL

Approvals per	UL 1059
Rated voltage UL (Use Group C)	600 V
Rated current UL (Use Group C)	20 A

Ratings per CSA

Approvals per	CSA 22.2 No 158
Rated voltage CSA (Use Group C)	600 V
Rated current CSA (Use Group C)	24 A

Power loss

Power loss, per pole (potential)	0.7661 W
Rated current I_N for specified power loss	24 A
Resistance value for specified, current-dependent power loss	0.00133 Ω

Connection data

Connection points	3
Total number of potentials	1
Number of levels	1

Connection 1

Connection technology	CAGE CLAMP®
Actuation type	Operating tool
Connectable conductor materials	Copper Aluminum

Connectable conductor materials (note) **Terminating Aluminum Conductors**
WAGO spring clamp terminal blocks are suitable for solid aluminum conductors up to 4 mm²/12 AWG if WAGO "Alu-Plus" Contact Paste [249-130](#) is used for termination.

"Alu-Plus" Contact Paste Advantages:

- Automatically destroys the oxide film during clamping.
- Prevents fresh oxidation at the clamping point.
- Prevents electrolytic corrosion between aluminum and copper conductors (in the same terminal block).
- Provides long-term protection against corrosion.

Using terminal blocks with CAGE CLAMP® Spring Pressure Connection Technology, **aluminum conductors must first be cleaned with a blade** and then immediately be inserted into the clamping units filled with "Alu-Plus" Contact Paste.

It is also possible to apply WAGO "Alu-Plus" **additionally** on the whole surface of the aluminum conductor before termination.

Please note that the nominal currents must be adapted to the reduced conductivity of the aluminum conductors::

2.5 mm² = 16 A

4 mm² = 22 A

Solid conductor	0.08 ... 2.5 mm ² / 28 ... 12 AWG
Fine-stranded conductor	0.08 ... 2.5 mm ² / 28 ... 12 AWG
Note (conductor cross-section)	12 AWG: THHN, THWN
Strip length	8 ... 9 mm / 0.31 ... 0.35 inches
Wiring direction	Front-entry wiring

Physical data

Width	5 mm / 0.197 inches
Height	64 mm / 2.52 inches
Depth from upper-edge of DIN-rail	28 mm / 1.102 inches

Mechanical data

Mounting type	DIN-35 rail
Marking level	Center marking

Material data

Note (material data)	Information on material data can be found here
Color	blue
Material group	I
Insulation material	Polyamide (PA66)
Flammability class per UL94	V0
Fire load	0.123 MJ
Weight	7.6 g

Environmental requirements

Processing temperature	-35 ... +85 °C
Continuous operating temperature	-60 ... +105 °C

Commercial data

Product Group	1 (Rail Mounted Terminal Blocks)
eCl@ss 10.0	27-14-11-20
eCl@ss 9.0	27-14-11-20
ETIM 8.0	EC000897
ETIM 7.0	EC000897
PU (SPU)	100 Stück
Packaging type	Box
Country of origin VKOrg Germany	DE
GTIN	4044918391412
Customs tariff number VKOrg Germany	85369010000

Approvals and certificates

General approvals



Approval	Standard	Certificate name
CCA DEKRA Certification B.V.	EN 60947	2157201.01
CSA DEKRA Certification B.V.	C22.2	1536071
UL Underwriters Laboratories Inc.	UL 1059	E45172

Approvals for marine applications



Approval	Standard	Certificate name
ABS American Bureau of Shipping	EN 60947	20-HG1941090-PDA
BV Bureau Veritas S.A.	EN 60947	07436/F0 BV
DNV GL Det Norske Veritas, Germanischer Lloyd	-	TAE00001V2
LR Lloyds Register	EN 60947	91/20112 (E9)

Downloads

Environmental Product Compliance

Compliance Search

Environmental Product Compliance 280-684



Documentation

Additional Information

Technical Section

pdf
2142.18 KB



Bid Text

280-684

19.02.2019

xml
3.24 KB



280-684

28.02.2017

doc
24.00 KB



CAD/CAE-Data

CAD data

2D/3D Models 280-684



CAE data

EPLAN Data Portal
280-684



WSCAD Universe
280-684



ZUKEN Portal 280-684



1 Compatible products

1.1 Required accessories

1.1.1 End plate

1.1.1.1 End plate



[Item no.: 280-324](#)

End and intermediate plate; 2.5 mm thick; gray



[Item no.: 280-326](#)

End and intermediate plate; 2.5 mm thick; orange



[Item no.: 209-191](#)

Separator for Ex e/Ex i applications; 3 mm thick; 120 mm wide; orange



[Item no.: 280-344](#)

Separator plate; 2 mm thick; oversized; gray



[Item no.: 280-346](#)

Separator plate; 2 mm thick; oversized; orange

1.2 Optional accessories

1.2.1 DIN-rail

1.2.1.1 Mounting accessories



Item no.: 210-196

Aluminum carrier rail; 35 x 8.2 mm; 1.6 mm thick; 2 m long; unslotted; similar to EN 60715; silver-colored



Item no.: 210-198

Copper carrier rail; 35 x 15 mm; 2.3 mm thick; 2 m long; unslotted; according to EN 60715; copper-colored



Item no.: 210-508

Steel carrier rail; 35 x 15 mm; 1.5 mm thick; 2 m long; slotted; galvanized; similar to EN 60715; silver-colored



Item no.: 210-197

Steel carrier rail; 35 x 15 mm; 1.5 mm thick; 2 m long; slotted; similar to EN 60715; silver-colored



Item no.: 210-506

Steel carrier rail; 35 x 15 mm; 1.5 mm thick; 2 m long; unslotted; galvanized; similar to EN 60715; silver-colored



Item no.: 210-114

Steel carrier rail; 35 x 15 mm; 1.5 mm thick; 2 m long; unslotted; similar to EN 60715; silver-colored



Item no.: 210-118

Steel carrier rail; 35 x 15 mm; 2.3 mm thick; 2 m long; unslotted; according to EN 60715; silver-colored



Item no.: 210-115

Steel carrier rail; 35 x 7.5 mm; 1 mm thick; 2 m long; slotted; according to EN 60715; "Hole width 18 mm; silver-colored



Item no.: 210-112

Steel carrier rail; 35 x 7.5 mm; 1 mm thick; 2 m long; slotted; according to EN 60715; "Hole width 25 mm; silver-colored



Item no.: 210-504

Steel carrier rail; 35 x 7.5 mm; 1 mm thick; 2 m long; slotted; galvanized; according to EN 60715; silver-colored



Item no.: 210-113

Steel carrier rail; 35 x 7.5 mm; 1 mm thick; 2 m long; unslotted; according to EN 60715; silver-colored



Item no.: 210-505

Steel carrier rail; 35 x 7.5 mm; 1 mm thick; 2 m long; unslotted; galvanized; according to EN 60715; silver-colored

1.2.2 End plate

1.2.2.1 End plate



Item no.: 284-334

Step-down cover plate; 1 mm thick; for 2-, 3- and 4-conductor terminal blocks; gray



Item no.: 284-344

Step-down cover plate; 1 mm thick; for 2-, 3- and 4-conductor terminal blocks; orange

1.2.3 Ferrule

1.2.3.1 Ferrule



Item no.: 216-301

Ferrule; Sleeve for 0.25 mm² / AWG 24; insulated; electro-tin plated; yellow



Item no.: 216-302

Ferrule; Sleeve for 0.34 mm² / 22 AWG; insulated; electro-tin plated; light turquoise



Item no.: 216-201

Ferrule; Sleeve for 0.5 mm² / 20 AWG; insulated; electro-tin plated; white



Item no.: 216-101

Ferrule; Sleeve for 0.5 mm² / AWG 22; un-insulated; electro-tin plated; silver-colored



Item no.: 216-202

Ferrule; Sleeve for 0.75 mm² / 18 AWG; insulated; electro-tin plated; gray



Item no.: 216-102

Ferrule; Sleeve for 0.75 mm² / AWG 20; un-insulated; electro-tin plated; silver-colored



Item no.: 216-203

Ferrule; Sleeve for 1 mm² / AWG 18; insulated; electro-tin plated; red



Item no.: 216-103

Ferrule; Sleeve for 1 mm² / AWG 18; un-insulated; electro-tin plated



Item no.: 216-204

Ferrule; Sleeve for 1.5 mm² / AWG 16; insulated; electro-tin plated; black



Item no.: 216-104

Ferrule; Sleeve for 1.5 mm² / AWG 16; un-insulated; electro-tin plated; silver-colored

1.2.4 Installation

1.2.4.1 Mounting accessories



Item no.: 709-167

Cover carrier; Type 1; incl. fixing/retaining screws and knurled nut; suitable for 279 to 282 and 880 Series rail-mounted terminal blocks; suitable for 264 Series miniature rail-mounted terminal blocks; suitable for 270 Series sensor and actuator terminal blocks; gray



Item no.: 709-153

Cover; Type 1; suitable for cover carrier, type 1; 1 m long; transparent



Item no.: 209-106

Mounting carrier; for isolated mounting on DIN 35 rails; gray



Item no.: 249-116

Screwless end stop; 6 mm wide; for DIN-rail 35 x 15 and 35 x 7.5; gray

1.2.5 Insulation stop

1.2.5.1 Insulation stop



Item no.: 280-470

Insulation stop; 0.08 - 0.2 mm² "s" (0.14 mm² "f-st"); 5 pieces/strip; white



Item no.: 280-471

Insulation stop; 0.25 - 0.5 mm²; 5 pieces/strip; light gray



Item no.: 280-472

Insulation stop; 0.75 - 1 mm²; 5 pieces/strip; black

1.2.6 Jumper

1.2.6.1 Jumper



Item no.: 280-490

Jumper; 10-way; insulated; gray



Item no.: 280-482

Jumper; 2-way; insulated; gray



Item no.: 280-492

Jumper; 2-way; insulated; gray



Item no.: 280-483

Jumper; 3-way; insulated; gray



Item no.: 280-484

Jumper; 4-way; insulated; gray



Item no.: 280-485

Jumper; 5-way; insulated; gray



Item no.: 280-402

Jumper; insulated; gray



Item no.: 280-409

Jumper; insulated; gray



Item no.: 280-422

Jumper; insulated; yellow-green



Item no.: 780-452

Staggered jumper; from 1 to 2; insulated; gray



Item no.: 780-453

Staggered jumper; from 1 to 3; insulated; gray



Item no.: 780-454

Staggered jumper; from 1 to 4; insulated; gray



Item no.: 780-455

Staggered jumper; from 1 to 5; insulated; gray



Item no.: 780-456

Staggered jumper; from 1 to 6; insulated; gray



Item no.: 780-457

Staggered jumper; from 1 to 7; insulated; gray



Item no.: 780-458

Staggered jumper; from 1 to 8; insulated; gray



Item no.: 284-414

Step-down jumper; from 284/282 to 281/280/279 series; insulated; gray



Item no.: 709-110

Wire commoning chain; 2.5 mm²; insulated; black



Item no.: 709-111

Wire commoning chain; 2.5 mm²; insulated; black



Item no.: 709-112

Wire commoning chain; 2.5 mm²; insulated; black



Item no.: 210-103

Wire commoning chain; insulated; black



Item no.: 210-123

Wire commoning chain; insulated; blue

1.2.7 Marking

1.2.7.1 Double marker carrier



[Item no.: 209-128](#)

Adaptor; gray

1.2.7.2 Group marker carrier



[Item no.: 209-140](#)

Group marker carrier; gray



[Item no.: 209-141](#)

Group marker carrier; gray



[Item no.: 209-142](#)

Group marker carrier; gray



[Item no.: 249-105](#)

Group marker carrier; gray

1.2.7.3 Marker



[Item no.: 793-5501](#)

WMB marking card; as card; for terminal block width 5 - 17.5 mm; stretchable 5 - 5.2 mm; plain; snap-on type; white



[Item no.: 793-501](#)

WMB marking card; as card; not stretchable; plain; snap-on type; white



[Item no.: 2009-115](#)

WMB-Inline; for Smart Printer; 1500 pieces on roll; stretchable 5 - 5.2 mm; plain; snap-on type; white

1.2.8 Plug

1.2.8.1 Diode plug



[Item no.: 280-803/281-420](#)

Component plug; 2-pole; with rectifier diode and LED; 10 mm wide; gray



[Item no.: 280-803/281-421](#)

Component plug; 2-pole; with rectifier diode and LED; 10 mm wide; gray

1.2.8.2 Empty component plug housing



[Item no.: 280-803](#)

Empty component plug housing; 10 mm wide; Type 4; 2-pole; gray

1.2.8.3 LED plug



[Item no.: 280-803/281-415](#)

Component plug; 2-pole; LED (red); 10 mm wide; gray



[Item no.: 280-803/281-416](#)

Component plug; 2-pole; LED (red); 10 mm wide; gray



[Item no.: 280-803/281-413](#)

Component plug; 2-pole; LED (red); 24 VDC; 10 mm wide; gray



[Item no.: 280-803/281-414](#)

Component plug; 2-pole; LED (red); 48 VDC; 10 mm wide; gray



[Item no.: 280-803/281-411](#)

Component plug; 2-pole; with diode 1N4007; 10 mm wide; gray

1.2.8.4 Neon indicator module



Item no.: 280-803/281-417

Component plug; 2-pole; 10 mm wide; gray

Item no.: 280-803/281-418

Component plug; 2-pole; 10 mm wide; gray

1.2.9 Protective warning marker

1.2.9.1 Cover



Item no.: 280-415

Protective warning marker; for 5 terminal blocks; with high-voltage symbol, black; yellow

1.2.10 Push-in type wire jumper

1.2.10.1 Jumper

Item no.: 249-126

Push-in type wire jumper; 0.75 mm²; insulated; 110 mm long; black

Item no.: 249-123

Push-in type wire jumper; 0.75 mm²; insulated; 180 mm long; black

Item no.: 249-127

Push-in type wire jumper; 0.75 mm²; insulated; 250 mm long; black

Item no.: 249-125

Push-in type wire jumper; insulated; 60 mm long; black

1.2.11 Test and measurement

1.2.11.1 Testing accessories



Item no.: 249-107

B-type spacer module; modular; e.g., for bridging commoned terminal blocks; gray



Item no.: 249-106

B-type test plug module; modular; 1,50 mm²; gray



Item no.: 249-142

L-type end module; modular; with rigid contact pin; End module; 1,50 mm²; gray



Item no.: 249-143

L-type spacer module; modular; e.g., bridging commoned terminal blocks; gray



Item no.: 249-141

L-type test plug module; modular; with spring-loaded contact pin; Center module; 1,50 mm²; gray



Item no.: 280-419

Spacer module; modular; bridging commoned terminal blocks; gray



Item no.: 280-404

Test plug adapter; 5 mm wide; for test plug (2.3 mm Ø); suitable for 1.5 mm² - 4 mm² tbs; gray



Item no.: 209-170

Test plug adapter; 8.3 mm wide; for 4 mm Ø test plugs; suitable for 1.5 mm² - 10 mm² tbs; gray



Item no.: 280-418

Test plug module; modular; suitable for all WAGO 280 and 780 Series rail-mounted terminal blocks with jumper slots in the current bar; gray



Item no.: 281-407

Test plug; 6 mm wide; Nominal current 24 A; for 0.08 mm² - 2.5 mm²; 2,50 mm²; gray

1.2.12 Tool

1.2.12.1 Operating tool



Item no.: 210-658

Operating tool; Blade: 3.5 x 0.5 mm; with a partially insulated shaft; angled; short; multicoloured

Item no.: 210-720

Operating tool; Blade: 3.5 x 0.5 mm; with a partially insulated shaft; multicoloured

Item no.: 210-657

Operating tool; Blade: 3.5 x 0.5 mm; with a partially insulated shaft; short; multicoloured

Installation notes

Installation

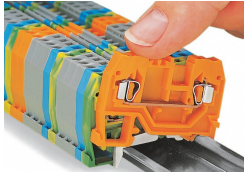

Snapping a terminal block onto the DIN-rail.

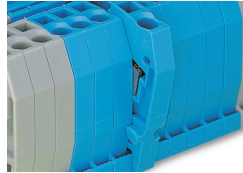

Quick assembly keys prevent reverse mounting.

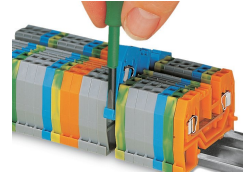

Removing a terminal block from the assembly.

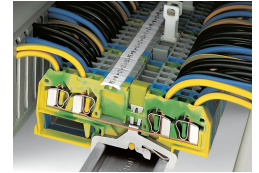

Steel DIN-rails are not suited for PEN (ground and N-conductor) applications per EN 60947-7-2 (VDE 0611, Part 3).

Conductor termination

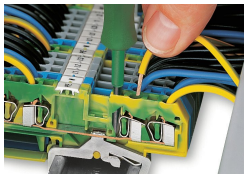

CAGE CLAMP® connection
Inserting a conductor.

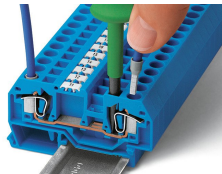

CAGE CLAMP® connection
Inserting a conductor.
With ferruled conductors, it is necessary to use a terminal block one size larger than the conductor's nominal cross-section.



Inserting insulation stops.

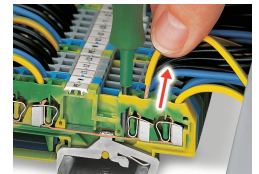

CAGE CLAMP® connection
Removing a solid conductor.

Testing

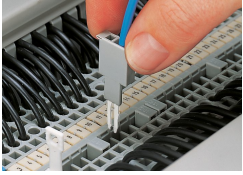

Testing with a test plug. Picture shows a test plug fitted with CAGE CLAMP®.

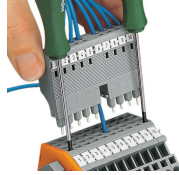

L-type test plug modules fitted with CAGE CLAMP®

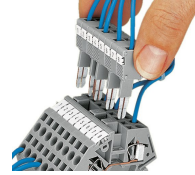

B-type test plug modules fitted with CAGE CLAMP®

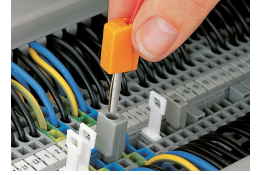

Testing with a test plug. Picture shows a test plug adapter (209-170).

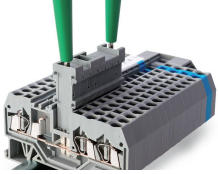

Test plugs modules are directly plugged into the jumper contact slot of the current bar.

Cover

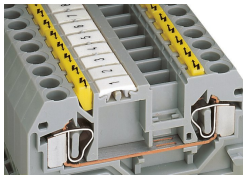

Protective warning markers inserted into the operating slots

Marking



Labeling via WMB Multi Marking System.

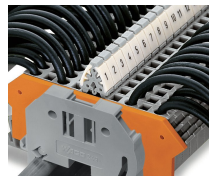

Terminal block marking with double marker carriers (209-128) Terminal blocks with side marking