

C3D06060A—Silicon Carbide Schottky Diode

Z-REC™ RECTIFIER

| | |
|--------------|---------|
| V_{RRM} | = 600 V |
| $I_{F(AVG)}$ | = 6 A |
| Q_c | = 16 nC |

Features

- 600-Volt Schottky Rectifier
- Zero Reverse Recovery Current
- Zero Forward Recovery Voltage
- High-Frequency Operation
- Temperature-Independent Switching Behavior
- Extremely Fast Switching
- Positive Temperature Coefficient on V_F

Benefits

- Replace Bipolar with Unipolar Rectifiers
- Essentially No Switching Losses
- Higher Efficiency
- Reduction of Heat Sink Requirements
- Parallel Devices Without Thermal Runaway

Applications

- Switch Mode Power Supplies
- Power Factor Correction
 - Typical PFC P_{out} : 600W-1200W
- Motor Drives
 - Typical Power : 2HP-3HP

Package

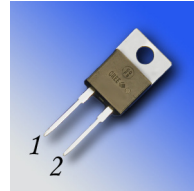

TO-220-2



| Part Number | Package | Marking |
|-------------|----------|----------|
| C3D06060A | TO-220-2 | C3D06060 |

Maximum Ratings

| Symbol | Parameter | Value | Unit | Test Conditions | Note |
|----------------|--|----------------|------------------|---|------|
| V_{RRM} | Repetitive Peak Reverse Voltage | 600 | V | | |
| V_{RSM} | Surge Peak Reverse Voltage | 600 | V | | |
| V_{DC} | DC Blocking Voltage | 600 | V | | |
| $I_{F(AVG)}$ | Average Forward Current | 6 | A | $T_c=150^\circ\text{C}$, DC | |
| I_{FRM} | Repetitive Peak Forward Surge Current | 41 27 | A | $T_c=25^\circ\text{C}$, $t_p = 10$ ms, Half Sine Wave, $D=0.3$ $T_c=110^\circ\text{C}$, $t_p=10$ ms, Half Sine Wave, $D=0.3$ | |
| I_{FSM} | Non-Repetitive Peak Forward Surge Current | 70 55 | A | $T_c=25^\circ\text{C}$, $t_p = 10$ mS, Half Sine Wave, $D=0.3$ $T_c=110^\circ\text{C}$, $t_p = 10$ mS, Half Sine Wave, $D=0.3$ | |
| I_{FSM} | Non-Repetitive Peak Forward Surge Current | 200 | A | $T_c=25^\circ\text{C}$, $t_p = 10$ μs , Pulse | |
| P_{tot} | Power Dissipation | 79 34 | W | $T_c=25^\circ\text{C}$ $T_c=110^\circ\text{C}$ | |
| T_j, T_{stg} | Operating Junction and Storage Temperature | -55 to +175 | $^\circ\text{C}$ | | |
| | TO-220 Mounting Torque | 1 8.8 | Nm lbf-in | M3 Screw 6-32 Screw | |

Electrical Characteristics

| Symbol | Parameter | Typ. | Max. | Unit | Test Conditions | Note |
|--------|-------------------------|-----------------|------------|---------------|--|------|
| V_F | Forward Voltage | 1.6 1.9 | 1.8 2.4 | V | $I_F = 6\text{ A}$ $T_J = 25^\circ\text{C}$ $I_F = 6\text{ A}$ $T_J = 175^\circ\text{C}$ | |
| I_R | Reverse Current | 10 20 | 50 200 | μA | $V_R = 600\text{ V}$ $T_J = 25^\circ\text{C}$ $V_R = 600\text{ V}$ $T_J = 175^\circ\text{C}$ | |
| Q_C | Total Capacitive Charge | 16 | | nC | $V_R = 600\text{ V}$, $I_F = 6\text{ A}$ $di/dt = 500\text{ A}/\mu\text{s}$ $T_J = 25^\circ\text{C}$ | |
| C | Total Capacitance | 294 27 26 | | pF | $V_R = 0\text{ V}$, $T_J = 25^\circ\text{C}$, $f = 1\text{ MHz}$ $V_R = 200\text{ V}$, $T_J = 25^\circ\text{C}$, $f = 1\text{ MHz}$ $V_R = 400\text{ V}$, $T_J = 25^\circ\text{C}$, $f = 1\text{ MHz}$ | |

Note:

1. This is a majority carrier diode, so there is no reverse recovery charge.

Thermal Characteristics

| Symbol | Parameter | Typ. | Unit |
|-----------------|--|------|---------------------------|
| $R_{\theta JC}$ | Thermal Resistance from Junction to Case | 1.9 | $^\circ\text{C}/\text{W}$ |

Typical Performance

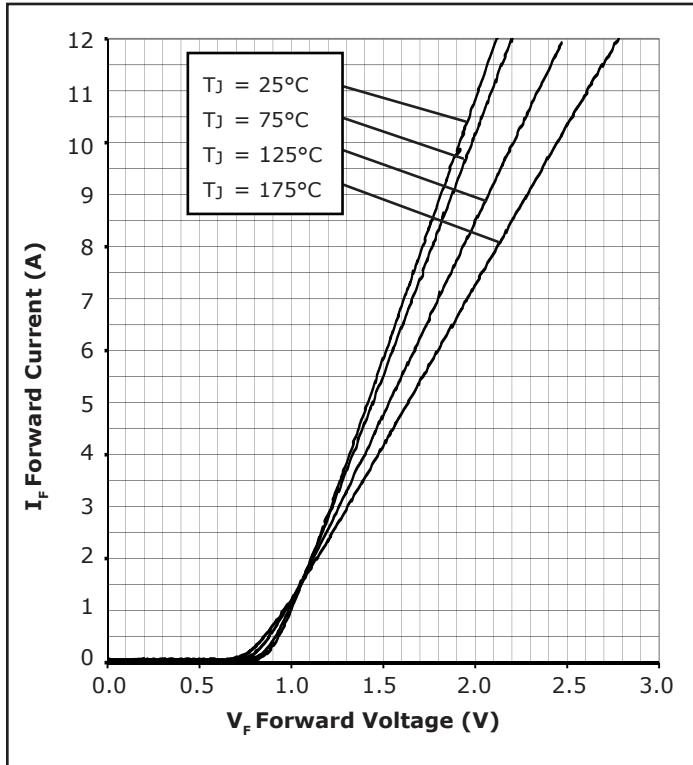

Figure 1. Forward Characteristics

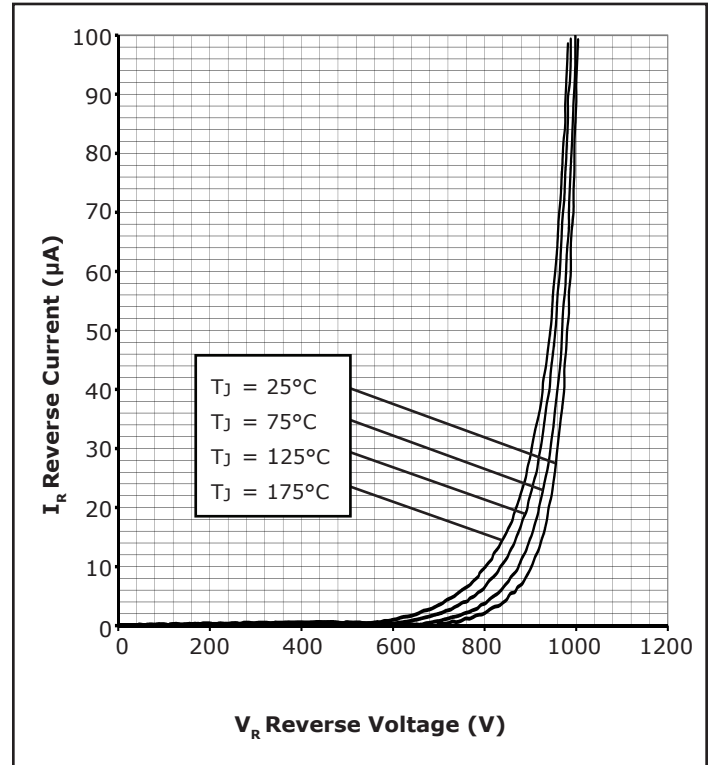

Figure 2. Reverse Characteristics

Typical Performance

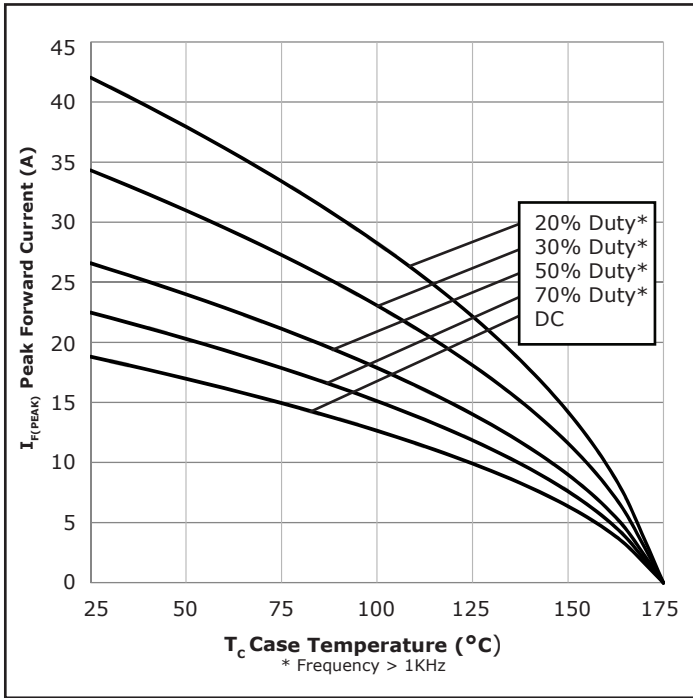

Figure 3. Current Derating

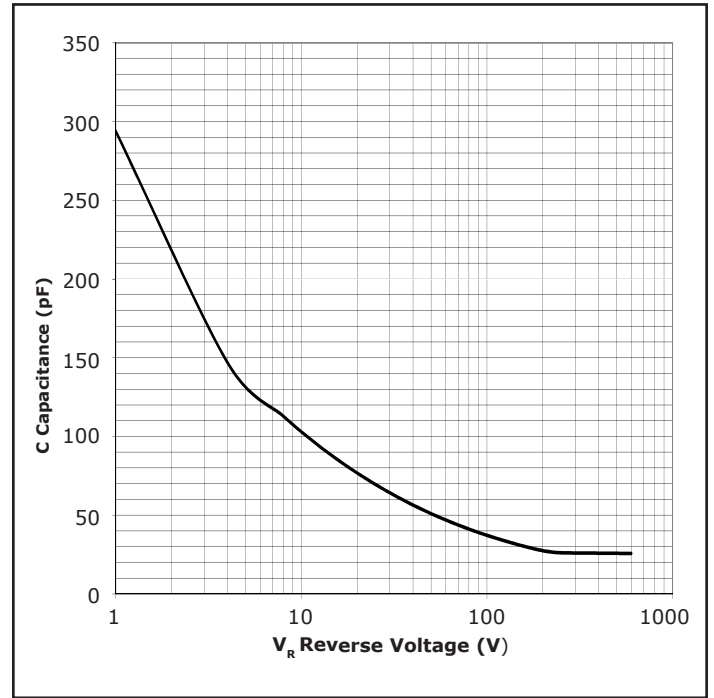

Figure 4. Capacitance vs. Reverse Voltage

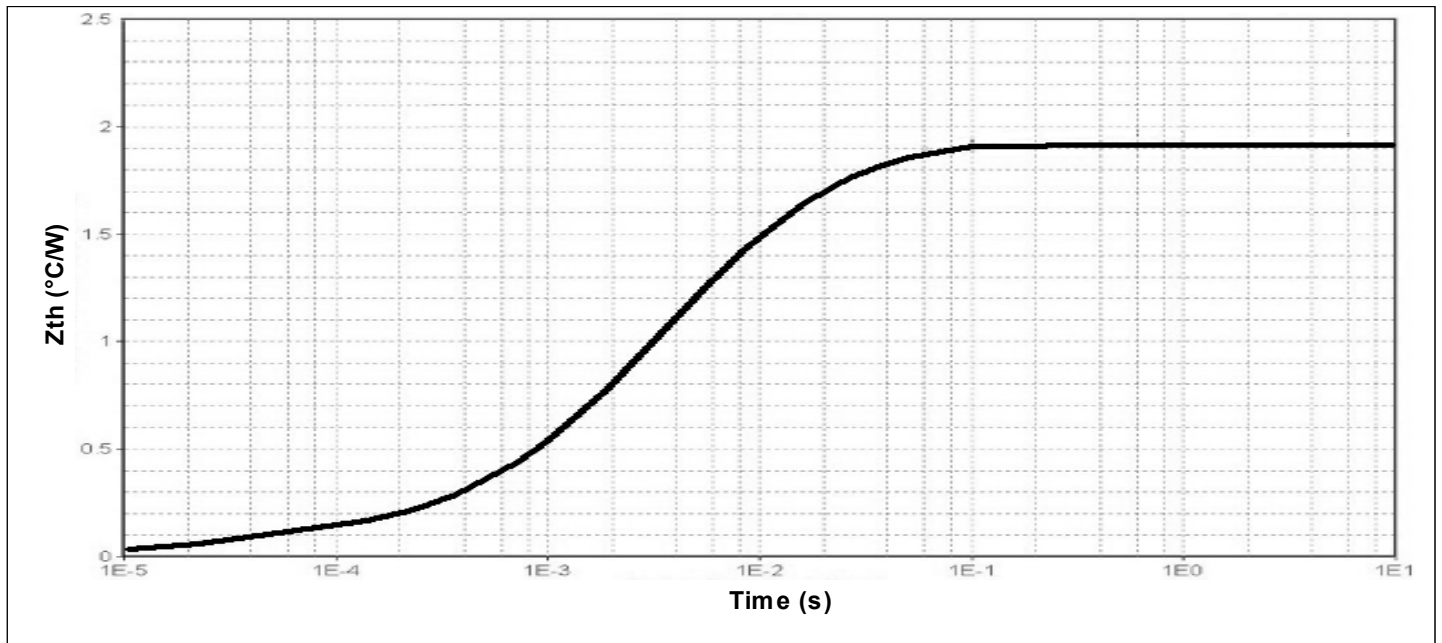

Figure 5. Transient Thermal Impedance

Typical Performance

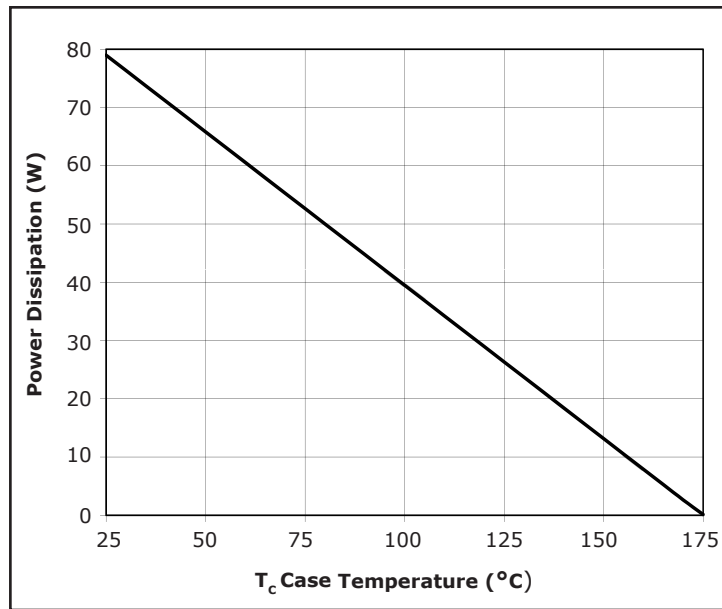
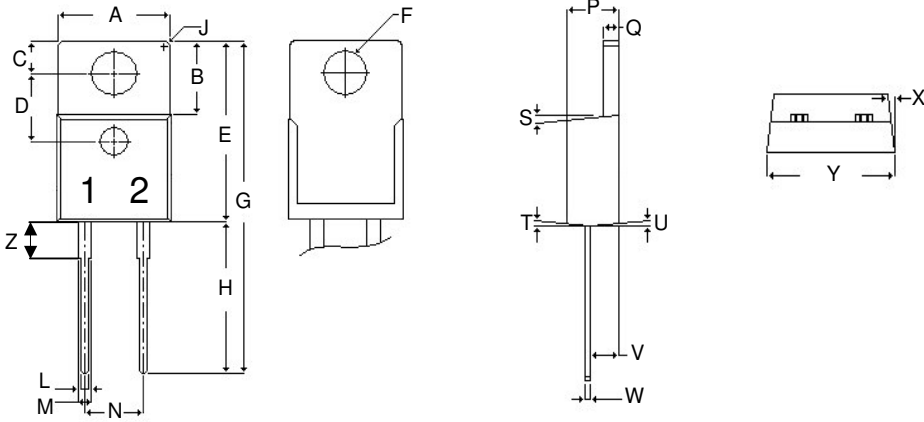

Figure 6. Power Derating

Package Dimensions

Package TO-220-2



| POS | Inches | | Millimeters | |
|-----|---------|-------|-------------|--------|
| | Min | Max | Min | Max |
| A | .381 | .410 | 9.677 | 10.414 |
| B | .235 | .255 | 5.969 | 6.477 |
| C | .100 | .120 | 2.540 | 3.048 |
| D | .223 | .337 | 5.664 | 8.560 |
| E | .590 | .615 | 14.986 | 15.621 |
| F | .143 | .153 | 3.632 | 3.886 |
| G | 1.105 | 1.147 | 28.067 | 29.134 |
| H | .500 | .550 | 12.700 | 13.970 |
| J | R 0.197 | | R 0.197 | |
| L | .025 | .036 | .635 | .914 |
| M | .045 | .055 | 1.143 | 1.397 |
| N | .195 | .205 | 4.953 | 5.207 |
| P | .165 | .185 | 4.191 | 4.699 |
| Q | .048 | .054 | 1.219 | 1.372 |
| S | 3° | 6° | 3° | 6° |
| T | 3° | 6° | 3° | 6° |
| U | 3° | 6° | 3° | 6° |
| V | .094 | .110 | 2.388 | 2.794 |
| W | .014 | .025 | .356 | .635 |
| X | 3° | 5.5° | 3° | 5.5° |
| Y | .385 | .410 | 9.779 | 10.414 |
| Z | .130 | .150 | 3.302 | 3.810 |

NOTE:

1. Dimension L, M, W apply for Solder Dip Finish

Recommended Solder Pad Layout

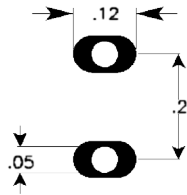

TO-220-2

| Part Number | Package | Marking |
|-------------|----------|----------|
| C3D06060A | TO-220-2 | C3D06060 |

Diode Model

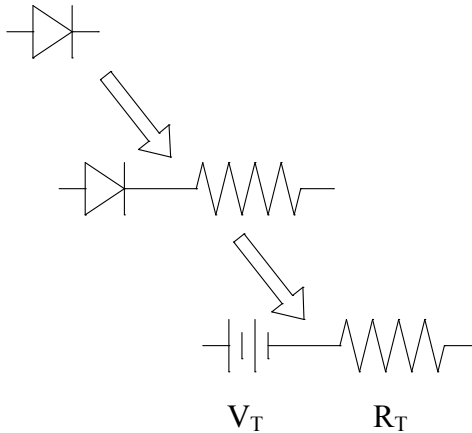

$$V_{fT} = V_T + I_f * R_T$$

$$V_T = 0.975 + (T_j * -1.0 * 10^{-3})$$

$$R_T = 0.09 + (T_j * 0.51 * 10^{-3})$$

Note: T_j = Diode Junction Temperature In Degrees Celcius

"The levels of environmentally sensitive, persistent biologically toxic (PBT), persistent organic pollutants (POP), or otherwise restricted materials in this product are below the maximum concentration values (also referred to as the threshold limits) permitted for such substances, or are used in an exempted application, in accordance with EU Directive 2002/95/EC on the restriction of the use of certain hazardous substances in electrical and electronic equipment (RoHS), as amended through April 21, 2006.

This product has not been designed or tested for use in, and is not intended for use in, applications implanted into the human body nor in applications in which failure of the product could lead to death, personal injury or property damage, including but not limited to equipment used in the operation of nuclear facilities, life-support machines, cardiac defibrillators or similar emergency medical equipment, aircraft navigation or communication or control systems, air traffic control systems, or weapons systems.

Copyright © 2009 Cree, Inc. All rights reserved. The information in this document is subject to change without notice. Cree and the Cree logo are registered trademarks and Z-Rec is a trademark of Cree, Inc.

Cree, Inc.
4600 Silicon Drive
Durham, NC 27703
USA Tel: +1.919.313.5300
Fax: +1.919.313.5451
www.cree.com/power