

SNG-25DB-086

Aliases (UALSNG25DB0860)

KEMET, SNG, AC Line Filters, Ground Wire, 0.086 mH, -30/+50%

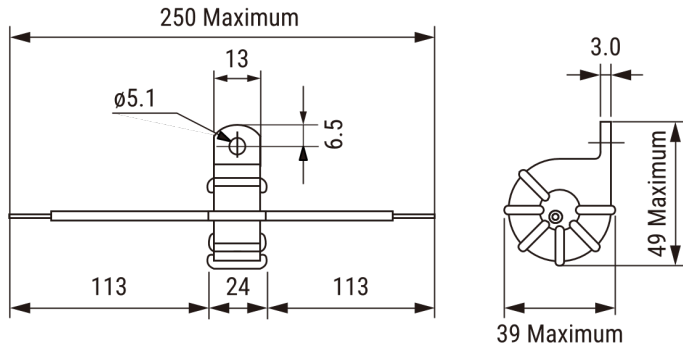

Click [here](#) for the 3D model.

General Information

Series	SNG
Style	Through-Hole
RoHS	Yes
Core	Mn-Zn Ferrite or Ni-Zn Ferrite

Specifications

Voltage AC	250 VAC
Voltage DC	250 VDC
Inductance	86 μ H (160 kHz)
Inductance Tolerance	-30/+50%
Temperature Range	-25/+105°C
DC Resistance	20 mOhms

Dimensions

D	39mm MAX
L	24mm NOM
H	49mm MAX
LL	113mm NOM
L2	250mm MAX
Wire Size	UL1015 AWG16

Packaging Specifications

Packaging	Bulk
Packaging Quantity	250
Component Weight	38 g

Statements of suitability for certain applications are based on our knowledge of typical operating conditions for such applications, but are not intended to constitute - and we specifically disclaim - any warranty concerning suitability for a specific customer application or use. This information is intended for use only by customers who have the requisite experience and capability to determine the correct products for their application. Any technical advice inferred from this information or otherwise provided by us with reference to the use of our products is given gratis, and we assume no obligation or liability for the advice given or results obtained.